

Register your instrument!
www.eppendorf.com/myeppendorf



Eppendorf PiezoXpert®

Operating manual

Copyright© 2020 Eppendorf AG, Germany. All rights reserved, including graphics and images. No part of this publication may be reproduced without the prior permission of the copyright owner.

Eppendorf® and the Eppendorf Brand Design are registered trademarks of Eppendorf AG, Germany.

3M™ and Fluorinert™ are protected trademarks of 3M Company, St. Paul, MN, USA.

Eppendorf PiezoXpert® is registered trademark of Eppendorf AG, Germany.

Registered trademarks and protected trademarks are not marked in all cases with ® or ™ in this manual.

Table of contents

1	Operating instructions	7
1.1	Using this manual	7
1.2	Danger symbols and danger levels	7
1.2.1	Danger symbols	7
1.2.2	Danger levels	7
1.3	Symbols used	7
2	Safety	8
2.1	Intended use	8
2.2	User profile	8
2.3	Information on product liability	8
2.4	Warnings for intended use	8
2.5	Safety instructions on the device	10
3	Product description	11
3.1	Delivery package	11
3.2	Features	11
3.3	Product overview	12
3.3.1	Operating controls	13
3.3.2	Display	14
3.3.3	Interfaces	15
3.4	Actuator	16
3.5	Foot control	17
3.6	Grip head 4	18
4	Installation	19
4.1	Preparing installation	19
4.1.1	Complaints about damages	19
4.1.2	Incomplete delivery	19
4.2	Selecting the location	19
4.3	Installing the actuator at the micromanipulator	20
4.4	Installing the actuator – TransferMan 4r/InjectMan 4	20
4.5	Installing the actuator – InjectMan NI 2/third-party supplier	21
4.6	Installing the actuator – TransferMan NK 2/PatchMan NP 2	21
4.6.1	Remodeling the X head	21
4.6.2	Installing the actuator	22
4.7	Inserting o-rings in the grip head	23
4.8	Mounting the capillary	24
4.8.1	Aligning angled capillaries	25
4.9	Connecting PiezoXpert	26
4.9.1	Connecting the actuator	26
4.9.2	Connecting the injection tube	26
4.9.3	Connecting a foot control	26
4.10	Connecting a micromanipulator	27

5	Operation	28
5.1	Setting piezo impulses	28
5.1.1	Setting parameters for piezo impulses	28
5.1.2	Saving parameters	28
5.1.3	Calling up saved parameters	28
5.2	Triggering piezo impulses	29
5.3	Triggering microinjection with piezo impulses	29
5.4	Optimizing parameters for capillaries	29
5.4.1	Application with heavy liquid	30
5.4.2	Optimizing parameters	30
5.5	Clean function	31
5.5.1	Calling up the Clean function	31
5.5.2	Terminating the Clean function	31
5.5.3	Changing parameters for the Clean function	31
5.5.4	Saving parameters for the Clean function	32
5.5.5	Calling up saved parameters for the Clean function	32
5.5.6	Triggering the Clean function	32
5.6	Setting the display contrast	32
6	Troubleshooting	33
6.1	General errors	33
6.1.1	Calling up error codes	33
6.2	Error messages	34
7	Maintenance	35
7.1	Exchanging the o-rings in the grip head	35
7.1.1	Remove the o-rings and distancing sleeves	35
7.1.2	Inserting the o-rings and the distance sleeve	36
7.2	Replacing microfuses	37
7.3	Cleaning	38
8	Technical data	39
8.1	Power supply	39
8.2	Weight/dimensions	39
8.3	Interfaces	39
8.4	Parameters of the piezo impulses	39
8.4.1	Impulse intensity parameter – Int	39
8.4.2	Impulse speed parameter – Speed	39
8.4.3	Impulse number parameter – Pulse	40
8.5	Clean function parameter	40
8.5.1	Impulse intensity parameter – Int	40
8.5.2	Impulse speed parameter – Speed	40
8.6	Ambient conditions	40

9	Transport, storage and disposal	41
9.1	Storage	41
9.2	Decontamination before shipment	41
9.3	Transport	41
9.4	Disposal	42
10	Ordering information	43
10.1	PiezoXpert	43
10.2	Accessories for PiezoXpert	43
10.3	Capillary	43
10.4	Grip heads 4 and spare parts	44
10.5	TransferMan 4r	44
10.6	InjectMan 4	44
10.7	CellTram 4r and accessories	45
	Certificates	47

6	Table of contents
	Eppendorf PiezoXpert®
	English (EN)

1 Operating instructions





1.1 Using this manual

- ▶ Read this operating manual completely before using the device for the first time. Observe the instructions for use of the accessories where applicable.
- ▶ This operating manual is part of the product. Please keep it in a place that is easily accessible.
- ▶ Enclose this operating manual when transferring the device to third parties.
- ▶ The current version of the operating manual for all available languages can be found on our webpage www.eppendorf.com/manuals.

1.2 Danger symbols and danger levels

1.2.1 Danger symbols

The safety instructions in this manual have the following danger symbols and danger levels:

	Toxic substances		Electric shock
	Cuts		Material damage
	Hazard point		

1.2.2 Danger levels

DANGER	<i>Will</i> lead to severe injuries or death.
WARNING	<i>May</i> lead to severe injuries or death.
CAUTION	May lead to light to moderate injuries.
NOTICE	May lead to material damage.

1.3 Symbols used

Depiction	Meaning
1. 2.	Actions in the specified order
▶	Actions without a specified order
•	List
<i>Text</i>	Display or software texts
	Additional information

2 **Safety**

2.1 **Intended use**

The PiezoXpert is intended to support micromanipulation and microinjection in research. The PiezoXpert is exclusively intended for indoor use.

2.2 **User profile**

The device and accessories may only be operated by trained and skilled personnel.

Before using the device, read the operating manual and the instructions for use of the accessories carefully and familiarize yourself with the device's mode of operation.

2.3 **Information on product liability**

In the following cases, the designated protection of the device may be affected. The liability for any resulting damage or personal injury is then transferred to the owner:

- The device is not used in accordance with the operating manual.
- The device is used outside of its intended use.
- The device is used with accessories or consumables that are not recommended by Eppendorf.
- The device is maintained or repaired by persons not authorized by Eppendorf AG.
- The user makes unauthorized changes to the device.

2.4 **Warnings for intended use**



WARNING! Damage to health from toxic, radioactive or aggressive chemicals, as well as infectious liquids and pathogenic germs.

- ▶ Observe the national regulations for handling these substances, the biosafety level of your laboratory, and the manufacturers' Safety Data Sheets and application notes.
- ▶ Wear your personal protective equipment.
- ▶ For comprehensive regulations about handling germs or biological material of risk group II or higher, please refer to the "Laboratory Biosafety Manual" (source: World Health Organization, Laboratory Biosafety Manual, in the currently valid version).



WARNING! Lethal voltages inside the device.

If you touch any parts which are under high voltage you may experience an electric shock. Electric shocks cause injuries to the heart and respiratory paralysis.

- ▶ Ensure that the housing is closed and undamaged.
 - ▶ Do not remove the housing.
 - ▶ Ensure that no liquids can penetrate the device.
- Only authorized service staff may open the device.



WARNING! Electric shock due to damage to the device or the mains/power cord.

- ▶ Only switch on the device if the device and the mains/power cord are undamaged.
- ▶ Only operate devices which have been installed or repaired properly.
- ▶ In case of danger, disconnect the device from the mains/power supply voltage. Disconnect the mains/power plug from the device or the earth/grounded socket. Use the isolating device intended for this purpose (e.g., the emergency switch in the laboratory).



WARNING! Danger due to incorrect voltage supply.

- ▶ Only connect the device to voltage sources which correspond with the electrical requirements on the name plate.
- ▶ Only use earth/grounded sockets with a protective earth (PE) conductor.
- ▶ Only use the mains/power cord supplied.



WARNING! Risk of injury due to flying capillaries and glass splinters.

If exposed to high pressures, capillaries may detach themselves from the grip heads and become projectiles.

Capillaries can crack as a result of incorrect handling.

- ▶ Wear protective goggles.
- ▶ Never aim capillaries at people.
- ▶ Use capillaries with an outer diameter that matches the grip head specifications.
- ▶ Always mount / dismount capillaries when they are depressurized.
- ▶ Mount the capillary correctly in the grip head.
- ▶ Do not touch the capillary with the Petri dish or other objects.



CAUTION! Poor safety due to incorrect accessories and spare parts

The use of accessories and spare parts other than those recommended by Eppendorf may impair the safety, functioning and precision of the device. Eppendorf cannot be held liable or accept any liability for damage resulting from the use of accessories and spare parts other than those recommended or from the improper use of such equipment.

- ▶ Only use accessories and original spare parts recommended by Eppendorf.



CAUTION! Risk of cuts when unpacking the capillaries

Capillaries can break as a result of incorrect unpacking.

- ▶ Do not reach into the capillary transport protection.



CAUTION! Risk of cuts from broken capillaries.

Capillaries are made of glass. They are very sharp and fragile.

- ▶ Wear your personal protective equipment (PPE).
- ▶ Always mount capillaries depressurized.
- ▶ Never aim capillaries at people.
- ▶ Handle the capillaries very carefully.

2.5 Safety instructions on the device

Depiction	Meaning	Location
	<ul style="list-style-type: none">▶ Follow the instructions in the operating manual.	Rear side of the device

3 Product description

3.1 Delivery package

Quantity	Description
1	PiezoXpert
1	Actuator
1	Grip head 4, size 0
1	Foot control
1	Spacer plate (for installation at the TransferMan NK 2 and PatchMan NP 2)
1	Mains/power cord
1	Operating manual

3.2 Features

The PiezoXpert is used for micromanipulation. The piezo impulses help to insert capillary into cells with a resistant cell membrane.

- Optimum transmission of the piezo impulses: The piezo element is located at the front of the capillary holder.
- Loss-free transmission of the piezo impulses: The actuator (capillary holder with piezo element) is attached immovably at the micromanipulator.
- Reproducible work: Intensity, speed (frequency) and number of the piezo impulses can be set in parallel in two application-specific parameter sets. Three storage locations are available for saving the settings.
- Cleaning function: Parameters for removing contamination at the capillary can be set and saved.
- Easy operation: The device can be operated intuitively. Piezo impulses can be triggered either on the device or with the foot control.

3.3 Product overview

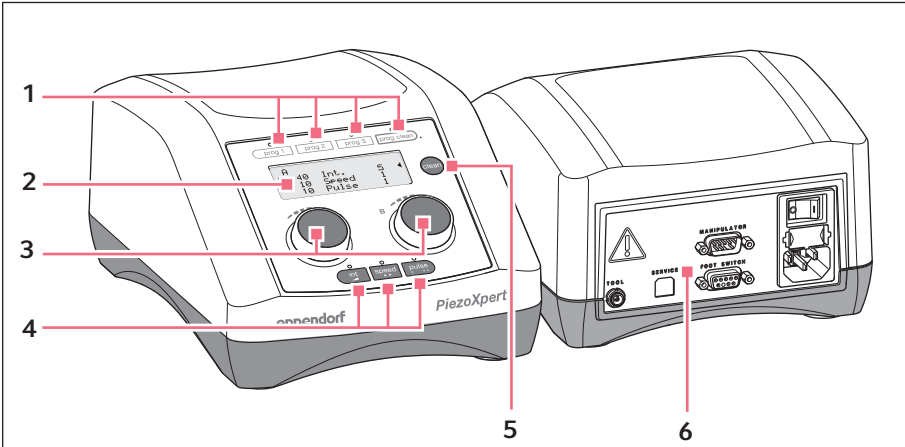

Fig. 3-1: Front and rear side

- | | |
|----------------|--------------------|
| 1 Program keys | 4 Parameter keys |
| 2 Display | 5 <i>clean</i> key |
| 3 Rotary knobs | 6 Interfaces |

3.3.1 Operating controls

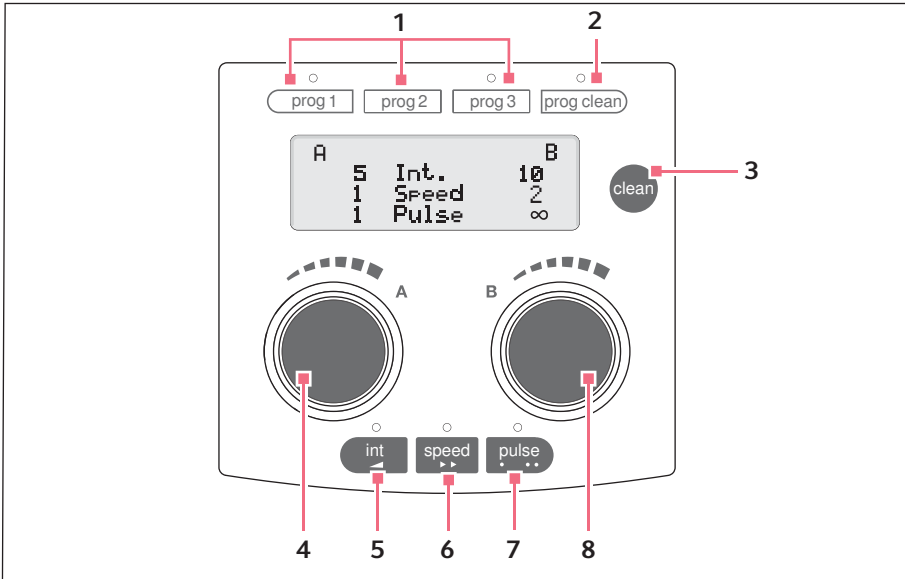

Fig. 3-2: Operating controls

- | | |
|---|---|
| <p>1 <i>prog 1, prog 2 und prog 3</i> program keys
Access or save A and B parameters</p> <p>2 <i>prog clean</i> program key</p> <p>3 <i>clean</i> key
Clean capillary</p> <p>4 <i>A</i> rotary knob
Set parameters or trigger impulse</p> | <p>5 <i>int</i> parameter key
Select Impulse intensity parameter</p> <p>6 <i>speed</i> parameter key
Select Impulse speed parameter</p> <p>7 <i>pulse</i> parameter key
Select Impulse amount parameter</p> <p>8 <i>B</i> rotary knob
Set parameters or trigger impulse</p> |
|---|---|

3.3.2 Display

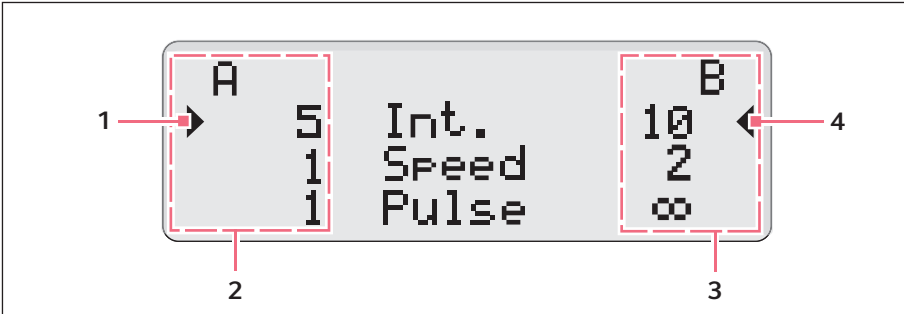

Fig. 3-3: Display

- | | |
|-------------------------------------|-------------------------------------|
| 1 Cursor
Active parameter | 3 B parameters |
| 2 A parameters | 4 Cursor
Active parameter |

3.3.3 Interfaces

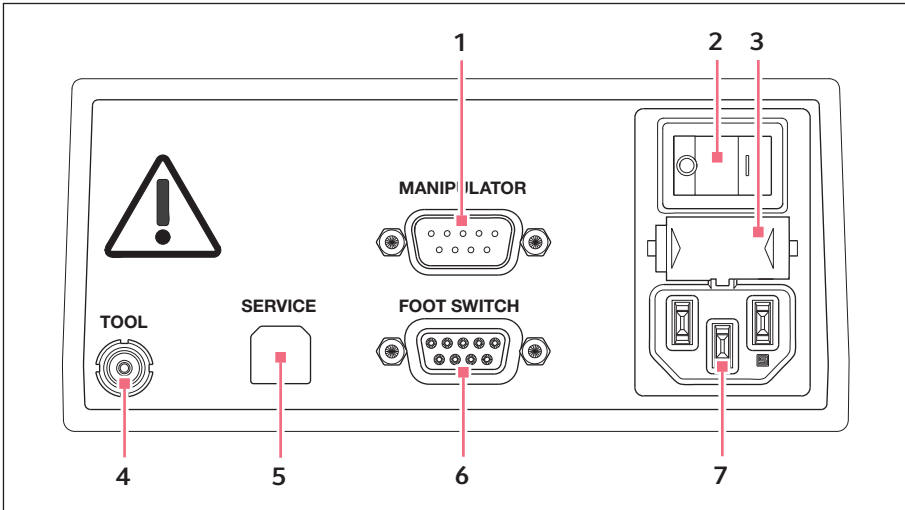

Fig. 3-4: Interfaces

- | | |
|---|---------------------------------|
| 1 Micromanipulator connection
TransferMan 4r or InjectMan 4 | 5 Service connection |
| 2 Mains/power switch on/off | 6 Foot pedal connection |
| 3 Micro fuse | 7 Mains/power connection |
| 4 Actuator connection | |

Product description

Eppendorf PiezoXpert®

English (EN)

3.4 Actuator

The actuator is fitted with a gray piezo element. Compared to the black predecessor model, the gray piezo element works with piezo impulses of reduced intensity. The reduced intensity allows gentler work processes.



The usual settings for the impulse intensity (black actuator) must be doubled for use with the gray actuator.

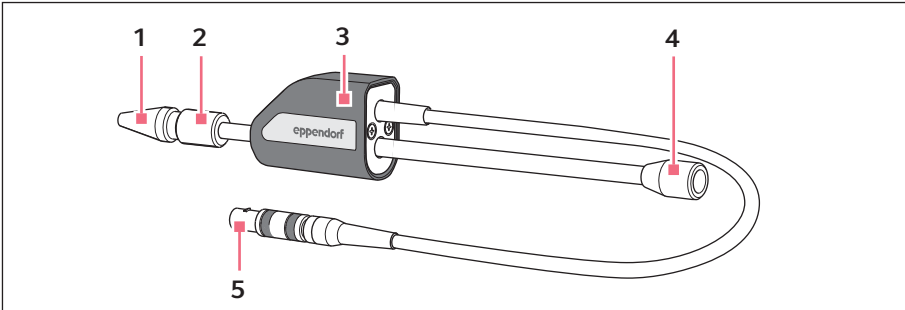

Fig. 3-5: Actuator

1 Grip head 4 for capillary

2 Front knurled screw

3 Piezo element
Gray housing

4 Port for microinjector

5 Connection to PiezoXpert

3.5 Foot control

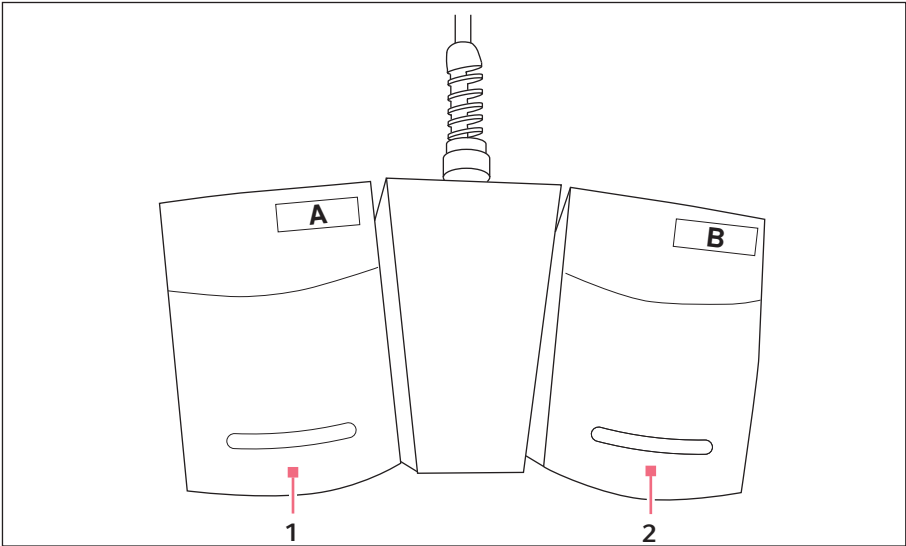

Fig. 3-6: Foot control

1 Trigger parameter set A

2 Trigger parameter set B

3.6 Grip head 4

The grip head is inserted in the actuator. There are different grip head sizes available for different capillary diameters. Grip heads can be differentiated based on the number of grooves they have.

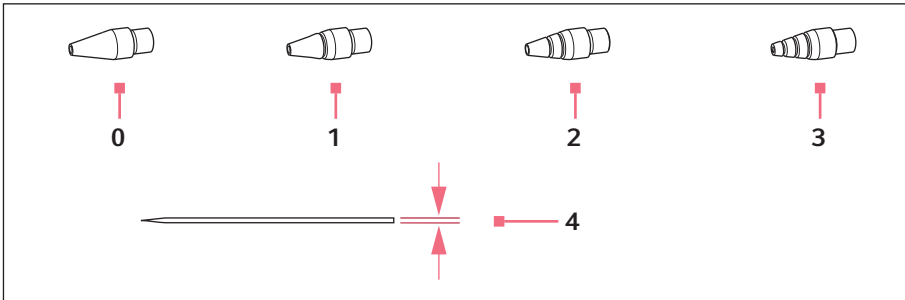



Fig. 3-7: Grip head sizes

- | | |
|---|---|
| 0 Size 0
For capillary diameters from 1.0 to 1.1 mm | 3 Size 3
For capillary diameters from 0.7 to 0.9 mm |
| 1 Size 1
For capillary diameters from 1.2 to 1.3 mm | 4 Capillary diameter |
| 2 Size 2
For capillary diameters from 1.4 to 1.5 mm | |

4 Installation

4.1 Preparing installation

-  Store the packaging for later transport or storage.
-  In case of visible damages on the device or the packaging, do not commission the Microinjector.

1. Check the packaging for damage.
2. Check that everything is included in the delivery.
3. Check the device and the accessories for damages.

4.1.1 Complaints about damages

- ▶ Contact your local Eppendorf distribution partner.

4.1.2 Incomplete delivery

- ▶ Contact your local Eppendorf distribution partner.

4.2 Selecting the location

Select the device location according to the following criteria:

- Suitable mains/power connection in accordance with the name plate.
 - A bench with a horizontal and even work surface which is designed to support the weight of the device.
 - The location is protected from direct sunlight and drafts.
-  The mains/power switch and the disconnecting device of the mains/power line must be easily accessible during operation (e.g., a residual current circuit breaker).

4.3 Installing the actuator at the micromanipulator

The actuator is mounted at the micromanipulator like a capillary holder.



NOTICE! Damage to the actuator.

Impacts or vibrations can cause the piezo element to malfunction or fail.

- ▶ Do not allow the actuator to fall.
- ▶ Do not expose the actuator to strong vibrations.
- ▶ If you suspect the actuator has been damaged, have it inspected by Eppendorf Service.



NOTICE! Damage to the piezo element.

The piezo element may become damaged if is twisted.

- ▶ It may only be rotated on the knurled screws.
- ▶ Do not use the piezo element as a lever.



When mounting the actuator for the first time, it may be necessary to remodel or realign the micromanipulator. Follow the instructions in the operating manual of your micromanipulator.

4.4 Installing the actuator – TransferMan 4r/InjectMan 4

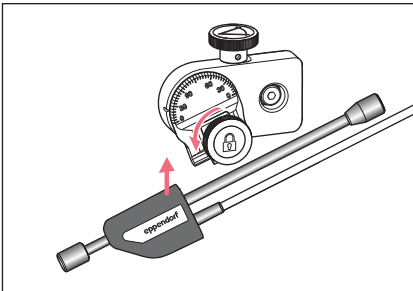

1. Loosen the knurled screw on the angle head.
2. Insert the actuator into the clamp.
The piezo element must be placed in front of the clamp.
3. Place the positioning aid on the actuator and tighten.
4. Tighten the knurled screw on the angle head.
5. Set an angle between 0° and a maximum of 25°.
The flatter the angle, the more direct is the effect of the piezo impulse.
Make sure that the actuator is fixed and that the holder cannot be moved.

4.5 Installing the actuator – InjectMan NI 2/third-party supplier



The piezo impulses can only be transmitted optimally to the capillary if the device is firmly assembled.

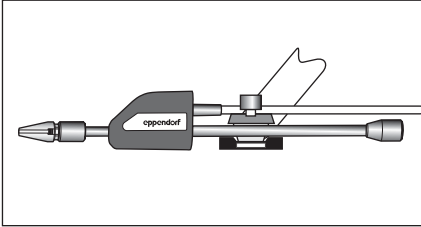

1. Loosen the knurled screw at the tool holder of the micromanipulator.
2. Insert the actuator into the holder.

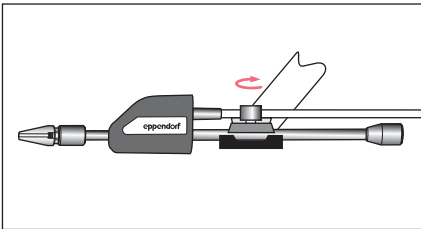

3. Tighten the knurled screw.
4. Set an angle between 0° and a maximum of 25°.
The flatter the angle, the more direct is the effect of the piezo impulse.
Make sure that the actuator is fixed and that the holder cannot be moved.

4.6 Installing the actuator – TransferMan NK 2/PatchMan NP 2

4.6.1 Remodeling the X head

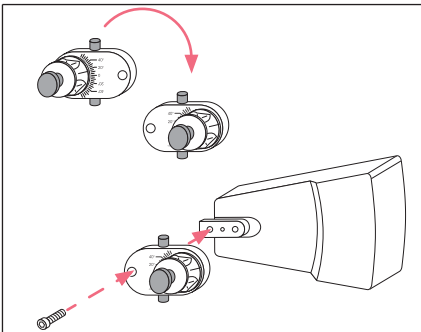

1. Loosen the cylinder screw and remove the X head.
2. Turn the X head by 180°.
3. Insert the X head with the fitting pin into the central hole of the tool holder.
4. Insert and tighten the cylinder screw.

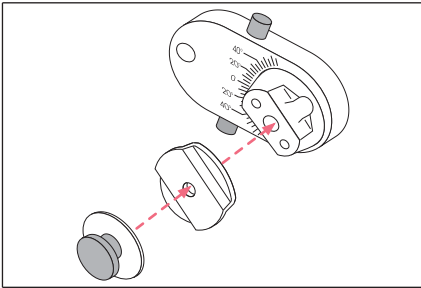

5. Loosen the knurled screw and remove it with the pressure plate.
6. Place the supplied spacer plate on the hole of the X head.
7. Attach and slightly tighten the knurled screw with pressure plate.

4.6.2 Installing the actuator

Prerequisites

- The micromanipulator is installed on the right side.



The piezo impulses can only be transmitted optimally to the capillary if the device is firmly assembled.

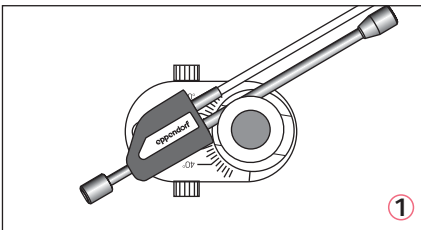

1. Insert the actuator into the top (1) or bottom (2) groove of the spacer plate.

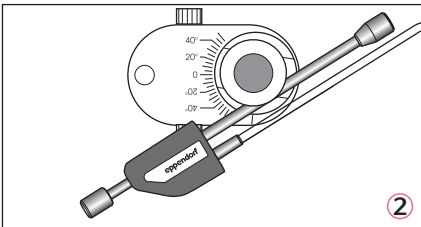

2. To fix the actuator, tighten the knurled screw.
3. Set an angle between 0° and a maximum of 25° .
The flatter the angle, the more direct is the effect of the piezo impulse.
Make sure that the actuator is fixed and that the holder cannot be moved.
Make sure that the piezo element is not distorted and pressed against a surface.

4.7 Inserting o-rings in the grip head

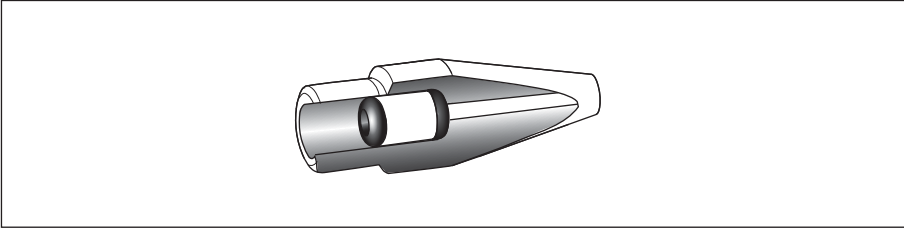
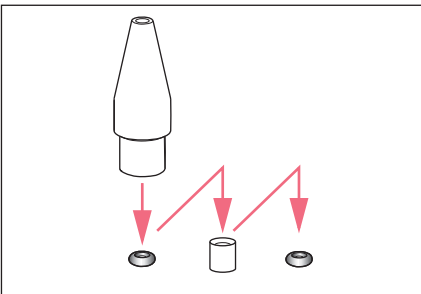

Fig. 4-1: Cross-section of the grip head with correctly inserted o-rings and distancing sleeve

Prerequisites

- The o-rings and the distancing sleeve are clean and free of damage.
- The grip head is clean and free of damage.
- A flat and clean surface is available.



1. Place the o-rings and the distancing sleeve on a flat surface.
2. Press the grip head vertically onto the first o-ring and push it into the grip head with the capillary holder.
3. Press the grip head vertically onto the distancing sleeve and push it into the grip head with the capillary holder.
4. Press the grip head vertically onto the second o-ring and push it into the grip head with the capillary holder.

4.8 Mounting the capillary



WARNING! Risk of injury due to flying capillaries and glass splinters.

If exposed to high pressures, capillaries may detach themselves from the grip heads and become projectiles.

Capillaries can crack as a result of incorrect handling.

- ▶ Wear protective goggles.
 - ▶ Never aim capillaries at people.
 - ▶ Use capillaries with an outer diameter that matches the grip head specifications.
 - ▶ Always mount / dismantle capillaries when they are depressurized.
 - ▶ Mount the capillary correctly in the grip head.
 - ▶ Do not touch the capillary with the Petri dish or other objects.
-



CAUTION! Risk of cuts from broken capillaries.

Capillaries are made of glass. They are very sharp and fragile.

- ▶ Wear your personal protective equipment (PPE).
 - ▶ Always mount capillaries depressurized.
 - ▶ Never aim capillaries at people.
 - ▶ Handle the capillaries very carefully.
-



NOTICE! Damage to the piezo element.

The piezo element may become damaged if it is twisted.

- ▶ It may only be rotated on the knurled screws.
 - ▶ Do not use the piezo element as a lever.
-



Standard capillary: Only use the grip head 4, size 0, with capillaries with an outer diameter of 1.0 mm to 1.1 mm. If you would like to use other capillaries, order the matching gear head.



To optimally transmit the piezo impulses to the capillary, the capillary must be in contact with the metal of the capillary stop. Make sure to insert the capillary into the actuator up to the stop.



Use straight capillaries or angled capillaries with an angle of up to 25°. If you want to use ground capillaries with spike, pre-test whether they are suitable.

Prerequisites

- The o-rings and distancing sleeve are inserted in the grip head.

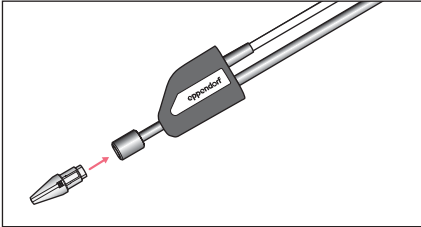

1. Loosely screw the grip head into the front knurled screw of the actuator.

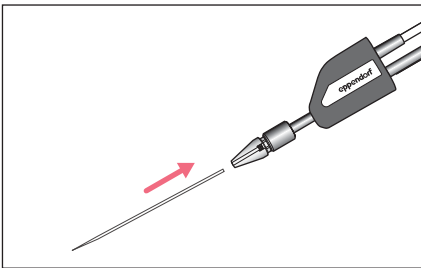

2. Continuously slide the capillary through the o-rings in the grip head until the capillary stop.
3. Tighten the grip head.
4. Move the capillary into the focus of the microscope.

4.8.1 Aligning angled capillaries



The front knurled screw with the grip head can be turned. The actuator is in a fixed position and does not turn.

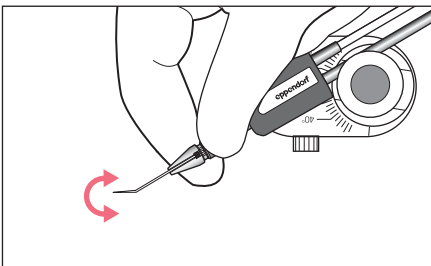

- ▶ To align angled capillaries, turn the front knurled screw.

4.9 Connecting PiezoXpert



WARNING! Danger due to incorrect voltage supply.

- ▶ Only connect the device to voltage sources which correspond with the electrical requirements on the name plate.



NOTICE! Material damage due to incorrect connections.

- ▶ Only make electrical connections to devices that are described in the operating manual.
 - ▶ Other connections are permitted with the agreement of Eppendorf AG only.
 - ▶ Only connect devices that meet the safety requirements defined in IEC 60950-1.
-

Prerequisites

- PiezoXpert is switched off.
 - The mains/power plug is disconnected.
1. Insert the mains/power cord into the mains/power connection.
 2. Insert the mains/power plug into the socket.

4.9.1 Connecting the actuator

- ▶ Connect the cable to the *TOOL* port of the *PiezoXpert*.

4.9.2 Connecting the injection tube

Prerequisites

- A Microinjector is connected.
- ▶ Connect the injection tube to the actuator.

4.9.3 Connecting a foot control

- ▶ Connect the foot control to the *FOOT SWITCH* port.

4.10 Connecting a micromanipulator

The following devices can be connected to the PiezoXpert:

- TransferMan 4r
- InjectMan 4

Prerequisites

- Y-cable PX is available.
1. Switch off both devices.
 2. Connect the Y-cable PX to the *ext. Device* port of the micromanipulator.
 3. Connect the Y-cable PX to the *MICROMANIPULATOR* port of the PiezoXpert.
 4. Switch on both devices.
The display of the micromanipulator shows *PiezoXpert ready*.

5 Operation

5.1 Setting piezo impulses

The *A* and *B* rotary knobs can be used to set the parameters for the parameter sets independently of each other. With the *prog 1*, *prog 2* and *prog 3* program keys, you can save both parameter sets simultaneously.

5.1.1 Setting parameters for piezo impulses

- *int* – Intensity of the piezo impulses. Strength of the piezo impulses.
Value between 1 – 86.
- *speed* – Speed of the piezo impulses. Frequency of the piezo impulses per second.
Value between 1 – 40.
- *pulse* – Number of piezo impulses. Number of the piezo impulses.
Value between 1 – 10 or ∞ (infinite).

1. Press a parameter key.
The control LED above the parameter key is illuminated.
The cursors mark the parameter in the display.
2. To change the parameter, turn the rotary knob for the parameter set.
The parameters are active immediately.



If one of the parameter keys is pressed, the parameter remains selected for 8 seconds. The control LED above the parameter key is illuminated. The control LED goes off when the parameter key is pressed again or the *clean* key or a program key is pressed.

If a parameter is selected and a piezo impulse is triggered, the parameter will remain selected for additional 8 seconds. This way, you can set, test and immediately change a parameter.

5.1.2 Saving parameters

Prerequisites

The parameters for the parameter sets are set.

- ▶ Press a program key for more than 1 second.
The control LED above the program key is illuminated.
The parameters are saved.



If you select settings for parameter set A and B which have already been saved, the LED above the program key is illuminated.

5.1.3 Calling up saved parameters

- ▶ To call up the saved parameters, shortly press a program key.
The saved parameters are shown in the display.

5.2 Triggering piezo impulses

The piezo impulses can be triggered via rotary knob or foot pedal.

Prerequisites

- The parameters for the piezo impulses are set or selected.
- ▶ Trigger the desired parameters.
As long as piezo impulses are emitted, the rotary knob is highlighted with a blue light circle.



Pulse ∞ (infinite): Piezo impulses are emitted for as long as the rotary knob or foot pedal is pressed.. After the series of impulses, the amount of piezo impulses emitted is shown in the display.

5.3 Triggering microinjection with piezo impulses

A microinjection can be combined with piezo impulses.

Prerequisites

- PiezoXpert and micromanipulator (TransferMan 4r or InjectMan 4) are connected.
 - Piezo impulses for parameter set *A* are set.
1. Switch on both devices.
The display of the micromanipulator shows *PiezoXpert ready*.
 2. Set parameters in the *PiezoXpert* menu of the micromanipulator.
 3. Trigger piezo impulses for parameter set *A*.

5.4 Optimizing parameters for capillaries

To make sure that the piezo impulse is transmitted directly and without losses, clarify the following questions:

- Which capillary is suitable for the planned application?
 - At which angle is the capillary inserted?
 - Do the capillaries have to be filled with heavy liquid (e.g., Flourinert) to ensure optimal impulse transmission?
- ▶ Set the piezo impulses that they are suitable for the application, the capillary used and the filling.

5.4.1 Application with heavy liquid

Prerequisites

- Liquid with a high specific density (e.g., Flourinert) is available.



WARNING! Damage to health due to toxic, radioactive or aggressive chemicals.

- ▶ Wear your personal protective equipment.
- ▶ Observe the national regulations for handling these substances.
- ▶ Observe the material safety data sheets and manufacturer's application notes.

The capillary can be weighed down to precisely transmit the piezo impulses to the sample.

1. Fill the capillary from behind via microloader free of air bubbles with heavy liquid.
2. Insert the capillary into the grip head up to the capillary stop.
3. Take in the medium through the front capillary opening.
4. Initially set a lower value (e.g. 10) for the *Int* parameter (intensity).

5.4.2 Optimizing parameters

The PiezoXpert offers you a wide range of setting options. Proceed as follows to determine the optimum parameters for your application:

1. Set a value of 1 for the impulse speed parameter (*Speed*).
2. Set a value of 1 for the impulse number parameter (*Pulse*).
3. Set a lower value (e.g. 2) for the impulse intensity parameter (*Int*).
4. Increase the value for impulse intensity incrementally until the piezo impulse is strong enough to penetrate the cell wall.
5. Adapt the impulse speed parameter.
6. Adapt the parameter for the impulse number.



Alternatively, you can start the impulse intensity with a high value of e.g. 30 and optimize the strength of the impulse with descending values.

5.5 Clean function

The *Clean* function can, for example, be used to remove contamination at the outside of the capillary.

The following parameters are factory set:

- *Int* – 20
- *Speed* – 20

5.5.1 Calling up the *Clean* function



1. To call up the *Clean* function, press the *prog clean* program key.
The display shows the set parameters.
2. To exit the *Clean* function, shortly press a program key.

The display shows the last used parameter sets.

Piezo impulses are transmitted to the capillary.

5.5.2 Terminating the *Clean* function

The function can be terminated with the following actions.

- ▶ Shortly press a program key.
- ▶ Shortly press a rotary knob.
- ▶ Actuate a foot control.

5.5.3 Changing parameters for the *Clean* function

- *Int* – Set a value between 1 and 86.
- *Speed* – Set a value between 1 and 40.



1. Press the *clean* key or the *prog clean* program key.
2. Press a parameter key.
The control LED above the parameter key is illuminated.
The cursor marks the selected parameter.
3. To change the parameter, turn the *B* rotary knob.
The parameters are active immediately.

5.5.4 Saving parameters for the *Clean* function

Prerequisites

- The parameter for *Int* is set.
- The parameter for *Speed* is set.
- ▶ Press the *prog clean* program key for more than 1 second.
The control LED above *prog clean* is illuminated.
The parameters are saved.

i If you select settings for *Clean* which have already been saved, the LED above the *prog clean* program key is illuminated.

5.5.5 Calling up saved parameters for the *Clean* function

- ▶ To call up the saved parameters, shortly press the *prog clean* program key.
The saved parameters are shown in the display.

5.5.6 Triggering the *Clean* function

- ▶ Keep the *clean* key pressed.
Transmit piezo impulses to the capillary.
The display shows the set parameters.

i If you release the *clean* key, the display will show the last used parameter sets after approx. 5 seconds.

5.6 Setting the display contrast

- Highest contrast – 0
- Lowest contrast – 100

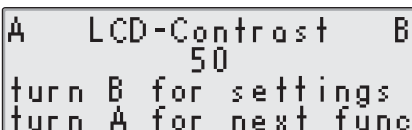

```

A  LCD-Contrast  B
      50
turn B for settings
turn A for next func
  
```

1. Press the *int* and *speed* keys simultaneously.
The display shows the *LCD-Contrast* menu.
2. To adjust the contrast of the display, turn the *B* rotary knob.
3. Press the *pulse* key to exit the menu.

6 Troubleshooting
6.1 General errors

Control functions ensure that the device can still be used, even if an error code is shown in the display. The errors are saved in a list, which can be displayed.

Problem	Solution
The display shows an error code.	▶ Press any key to acknowledge the error code.
An error code is displayed again.	▶ Switch the device off and back on again.

6.1.1 Calling up error codes

Use this function to display the error codes of the last 10 errors.

1. Press the *int* and *speed* keys simultaneously.
The display shows the *LCD-Contrast* menu.

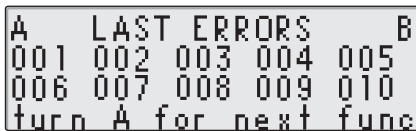

2. To show the saved error codes, turn the *A* rotary knob.
Under *LAST ERRORS*, the display shows the error codes of the last 10 errors.

6.2 Error messages



If the suggested troubleshooting measures fail repeatedly, please contact your local Eppendorf partner. The addresses can be found on the website www.eppendorf.com.

Problem	Cause	Solution
Display remains dark.	<ul style="list-style-type: none"> The device is not connected to the mains/power line or you did not actuate the mains/power switch. 	<ul style="list-style-type: none"> ▶ Check the mains/power connection and power cables. ▶ Switch the device on.
The display shows: <i>Please connect Actuator!</i>	<ul style="list-style-type: none"> The actuator is not connected. 	<ul style="list-style-type: none"> ▶ Press any key to acknowledge the error code. ▶ Connect the actuator. ▶ Check the connection of the actuator at the PiezoXpert.
	<ul style="list-style-type: none"> The actuator is defective. 	<ul style="list-style-type: none"> ▶ Press any key to acknowledge the error code. ▶ Replace the actuator. ▶ Have the defective actuator checked by Eppendorf.
The display shows an error message.	<ul style="list-style-type: none"> A control function has detected an error. 	<ul style="list-style-type: none"> ▶ Press any key to acknowledge the error code. ▶ Switch the device off and back on again. ▶ If error messages continue to be displayed, please contact the technical service.

7 Maintenance

7.1 Exchanging the o-rings in the grip head

If you notice leaks on the grip head, the o-rings must be exchanged.

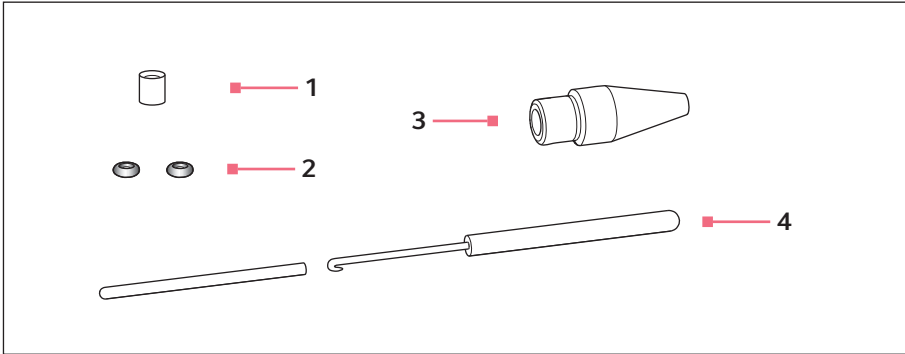

Fig. 7-1: Grip head 4 with removal tool

1 Distance sleeve

3 Grip head 4 size 0

2 O-rings
Inner diameter 1.0 mm

4 Removal tool
Hook with protective sleeve

7.1.1 Remove the o-rings and distancing sleeves

Prerequisites

- The grip head has been unscrewed from the capillary holder.
- The capillary has been removed from the grip head.

The hook of the removal tool is used to pull out the o-rings and the distance sleeve.

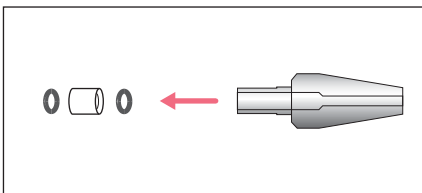

1. Pull out the first o-ring.
2. Pull out the distance sleeve.
3. Pull out the second o-ring.

7.1.2 Inserting the o-rings and the distance sleeve

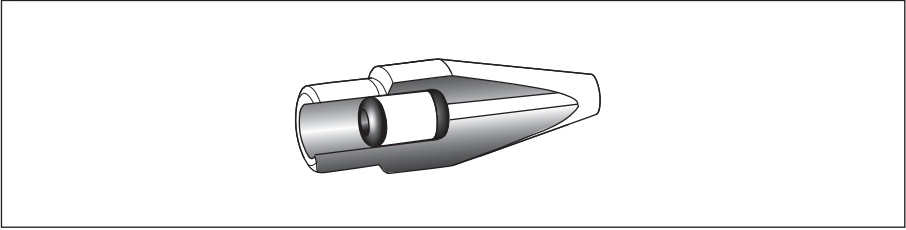
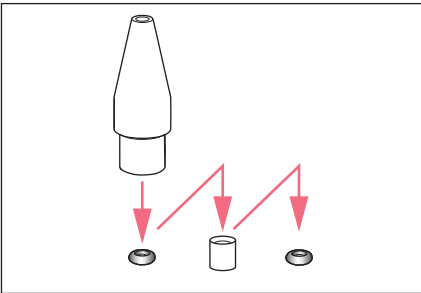

Fig. 7-2: Cross section with correctly positioned o-rings and spacing sleeve

Prerequisites

- The o-rings are clean and free of damage.
- The grip head is clean and free of damage.
- A clean and flat surface is available.
- O-rings matching the grip head size are available.



1. Place the new o-rings and the distance sleeve on a flat surface.
2. Press the grip head vertically onto the first o-ring and push the o-ring into the grip head using the capillary holder.
3. Press the grip head vertically onto the distance sleeve and push the distance sleeve into the grip head using the capillary holder.
4. Press the grip head vertically onto the second o-ring and push the o-ring into the grip head using the capillary holder.

7.2 Replacing microfuses



DANGER! Electric shock.

- ▶ Switch off the device and disconnect the mains/power plug before commencing any service or cleaning procedures.

The fuse holder is located between the mains/power connection and the mains/power switch.

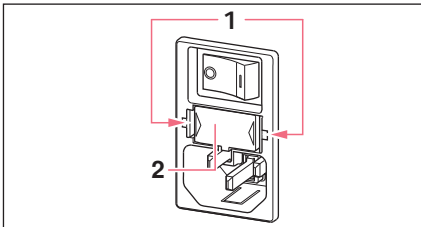

1. Disconnect the mains plug.
2. Press the clamps **1** together.
3. Remove the fuse holder **2**.

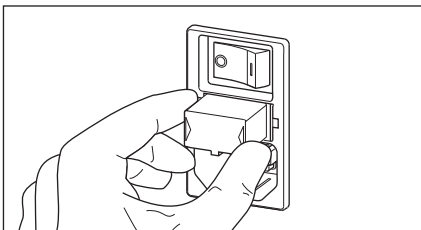

4. Replace defective fuses and insert the fuse holder.
5. Connect the mains/power plug.

7.3 Cleaning

**DANGER! Electric shock due to the ingress of liquid.**

- ▶ Switch off the device and disconnect it from the mains/power line before commencing any cleaning or disinfection procedures.
 - ▶ Do not allow any liquids to penetrate the inside of the housing.
 - ▶ Do not spray clean or spray disinfect the housing.
 - ▶ Only reconnect the device to the mains/power line when it is completely dry, both inside and outside.
-

**NOTICE! Damage from the use of aggressive chemicals.**

- ▶ Do not use any aggressive chemicals on the device or its accessories, such as strong and weak bases, strong acids, acetone, formaldehyde, halogenated hydrocarbons or phenol.
- ▶ If the device has been contaminated by aggressive chemicals, clean it immediately using a mild cleaning agent.

**NOTICE! Damage to the actuator due to penetrating liquid.**

Penetrating liquid can damage the piezo element.

- ▶ Do not clean the actuator under running water.
-

Prerequisites

- Mild cleaning agent
- Demineralized water
- Cloth
- ▶ Wet a cloth with cleaning agent and demineralized water.
- ▶ Remove contamination from the device and accessories.

8 Technical data

8.1 Power supply

Mains/power connection	100 V to 240 V $\pm 10\%$, 50 Hz to 60 Hz Adaptation to the voltage takes place automatically.
Fuse at 100 V to 240 V	T3, 15 A, 250 V
Power consumption	18 W
Protection class	I
Overvoltage category	II

8.2 Weight/dimensions

Weight	1.7 kg
Width	17 cm (6.69 in)
Height	11.5 cm (4.53 in)
Depth	23 cm (9.06 in)

8.3 Interfaces

USB	For service personnel only.
RS-232	For connection to micromanipulators (InjectMan 4 and TransferMan 4r).

8.4 Parameters of the piezo impulses

8.4.1 Impulse intensity parameter – *Int*

Range of values

Maximum	1 – 86
1 – 22	Increment 1
22 – 86	Increment 4

8.4.2 Impulse speed parameter – *Speed*

Range of values

Maximum	1 – 40
1 – 10	Increment 1
10 – 20	Increment 2
20 – 34	Increment 5
34 – 40	Increment 25

8.4.3 Impulse number parameter – *Pulse*

Range of values	
Maximum	1 – 10, ∞
1 – 10	Increment 1

8.5 *Clean* function parameter

8.5.1 Impulse intensity parameter – *Int*

Range of values	
Maximum	1 – 86
1 – 22	Increment 1
22 – 86	Increment 4

8.5.2 Impulse speed parameter – *Speed*

Range of values	
Maximum	1 – 40
1 – 10	Increment 1
10 – 20	Increment 2
20 – 34	Increment 5
34 – 40	Increment 25

8.6 Ambient conditions

Ambience	Only for use indoors.
Ambient temperature	15 °C to 35 °C
Relative humidity	30 % to 65 %, condensation not permitted.
Atmospheric pressure	80 kPa to 106 kPa Use up to an altitude of 2000 m above MSL.
Degree of pollution	2

9 Transport, storage and disposal

9.1 Storage

	Air temperature	Relative humidity	Atmospheric pressure
In transport packing	-25 °C – 55 °C	10 % – 95 %	70 kPa – 106 kPa
Without transport packing	-5 °C – 45 °C	10 % – 95 %	70 kPa – 106 kPa

9.2 Decontamination before shipment

If you are shipping the device to the authorized Technical Service for repairs or to your authorized dealer for disposal please note the following:



WARNING! Risk to health from contaminated device.

1. Observe the information in the decontamination certificate. It is available as a PDF document on our webpage (www.eppendorf.com/decontamination).
2. Decontaminate all the parts to be shipped.
3. Include the fully completed decontamination certificate in the shipment.

9.3 Transport

► Use the original packaging and the transport securing devices for transport.

	Air temperature	Relative humidity	Atmospheric pressure
General transport	-25 °C – 60 °C	10 % – 95 %	30 kPa – 106 kPa
Air freight	-40 °C – 55 °C	10 % – 95 %	30 kPa – 106 kPa

9.4 Disposal

The product must be disposed of in accordance with the relevant legal provisions.

Information on the disposal of electrical and electronic devices in the European Community:

Within the European Community, the disposal of electrical devices is regulated by national regulations based on EU Directive 2012/19/EU pertaining to waste electrical and electronic equipment (WEEE).

According to these regulations, any devices supplied after August 13, 2005, in the business-to-business sphere, to which this product is assigned, may no longer be disposed of in municipal or domestic waste. They are marked with the following symbol to indicate this:



As the disposal regulations may differ from one country to another within the EU, please contact your supplier for more information.

10 Ordering information

10.1 PiezoXpert

Order no. (International)	Order no. (North America)	Description
		Eppendorf PiezoXpert
5194 000.016	–	for piezo-assisted micromanipulation with mains/power plug EU
5194 000.024	5194000024	with mains/power plug USA/Japan
5194 000.032	5194000032	with mains/power plug UK/Hong Kong
5194 000.059	5194000059	with mains/power plug Australia
5194 000.067	5194000067	with mains/power plug China
5194 000.075	5194000075	with mains/power plug Argentina

10.2 Accessories for PiezoXpert

Order no. (International)	Order no. (North America)	Description
5194 075.156	5194075156	Actuator for PiezoXpert
5194 075.300	5194075300	Spacer Plate for mounting the PiezoXpert on the TransferMan NK 2, or PatchMan NP 2
5194 075.202	5194075202	Foot control for PiezoXpert
5192 081.000	5192081000	Y-cable PX
5194 075.407	5194075407	Tube adapter for tubes with outer diameter 2 mm or 3 mm

10.3 Capillary

Order no. (International)	Order no. (North America)	Description
5195 000.087	5195000087	Piezo Drill Tip ICSI 25 pieces, sterile
5195 000.095	5195000095	Piezo Drill Tip ES 25 pieces, sterile

10.4 Grip heads 4 and spare parts

Order no. (International)	Order no. (North America)	Description
5196 082.001	5196082001	Grip head set 4 for capillary holder 4 and universal capillary holder Size 0, capillary diameters from 1.0 mm to 1.1 mm (O.D.)
5196 083.008	5196083008	Size 1, capillary diameters from 1.2 mm to 1.3 mm (O.D.)
5196 084.004	5196084004	Size 2, capillary diameters from 1.4 mm to 1.5 mm (O.D.)
5196 085.000	5196085000	Size 3, capillary diameters from 0.7 mm to 0.9 mm (O.D.)
5196 086.007	5196086007	O-ring set 4 incl. 10 o-rings large, 10 o-rings small, 2 distance sleeves, o-ring removal tool for grip head set 4

10.5 TransferMan 4r

Order no. (International)	Order no. (North America)	Description
5193 000.012	5193000012	TransferMan 4r Mains/Power plug Europe
5193 000.020	5193000020	Mains/Power plug USA/Japan
5193 000.039	5193000039	Mains/Power plug UK/Hong Kong
5193 000.047	5193000047	Mains/Power plug Australia
5193 000.055	5193000055	Mains/Power plug China
5193 000.063	5193000063	Mains/Power plug Argentina

10.6 InjectMan 4

Order no. (International)	Order no. (North America)	Description
5192 000.019	5192000019	InjectMan 4 Mains/Power plug Europe
5192 000.027	5192000027	Mains/Power plug USA/Japan
5192 000.035	5192000035	Mains/Power plug UK/Hong Kong
5192 000.043	5192000043	Mains/Power plug Australia
5192 000.051	5192000051	Mains/Power plug China
5192 000.060	5192000060	Mains/Power plug Argentina

10.7 CellTram 4r and accessories

Order no. (International)	Order no. (North America)	Description
5196 000.013	5196000013	CellTram 4r Air
5196 000.030	5196000030	CellTram 4r Oil
5196 061.004	5196061004	Injection tube Air White ring mark, I.D. 0.5 mm, length 1.3 m
5196 089.006	5196089006	Injection tube Oil Blue ring mark, I.D. 1.0 mm, length 1.3 m
5176 220.009	5176220009	Tube coupling for extending or connecting injection tubes
5196 088.000	5196088000	Filling and Cleaning set incl. filling tube, Luer lock adapter, 2 syringes CellTram 4

Declaration of Conformity

The product named below fulfills the requirements of directives and standards listed. In the case of unauthorized modifications to the product or an unintended use this declaration becomes invalid.

Product name:

Eppendorf PiezoXpert®

Product type:

Device for piezo- assisted micromanipulation

Relevant directives / standards:

2014/35/EU: EN 61010- 1

UL 61010- 1, CAN/CSA C22.2 No. 61010- 1

2014/30/EU: EN 55011, EN 61326- 1

2011/65/EU: EN 50581

Date: February 03, 2016



Management Board



Portfolio Management

Your local distributor: www.eppendorf.com/contact
Eppendorf AG · 22331 Hamburg · Germany
eppendorf@eppendorf.com

Eppendorf® and the Eppendorf logo are registered trademarks of Eppendorf AG, Germany.
U.S. Design Patents are listed on www.eppendorf.com/sp.
All rights reserved, incl. graphics and pictures. Copyright 2015 © by Eppendorf AG.

www.eppendorf.com

ISO 9001
Certified

ISO
13485
Certified

ISO
14001
Certified

Evaluate Your Manual

Give us your feedback.
www.eppendorf.com/manualfeedback

Your local distributor: www.eppendorf.com/contact
Eppendorf AG · Barkhausenweg 1 · 22339 Hamburg · Germany
eppendorf@eppendorf.com · www.eppendorf.com