

# BIO NEWS

No. 54 – 2021

eppendorf



## Fit for the Future: SciVario® twin

- > Centrifuge 5425 R: more coolness, for you and your samples
- > Cost reduction in the cell culture lab
- > Eppendorf Planet of Knowledge: virtual world of experience

### Application Notes

Parallel fed-batch CHO culture on SciVario® twin · Microinjection in early embryos of zebrafish and medaka: from transgenesis to CRISPR · etc.





# Welcome

to a new issue of BioNews. In the leading article and in Application Note 1–2, we present the modular bioreactor control system SciVario® twin. With this system, you can adapt quickly and efficiently to changing requirements in the bioprocess laboratory. This way you stay fit for the future!

With the new Centrifuge 5425 R, we present the cool successor to the legendary microcentrifuge 5424 R (p. 6). And there is even more news when it comes to centrifugation! With the acquisition of the successful Japanese brand Himac, we are expanding and consolidating our centrifuge business for the pharmaceutical and life sciences sectors as well as for academic and industrial research (p. 7).

Make several laboratories quickly work as one and coordinate experimental work across different laboratory groups and locations – eLABJournal® makes it possible. You can find a practical example on p. 12.

Other articles deal with cost reduction in the cell culture laboratory, Eppendorf OEM solutions, and sustainability. And as always, Application Notes and a competition round off the issue.

In a chaotic year full of cancelled live events, all our creativity was (and still is) required to stay in touch with our customers. One result is the new internet platform “Eppendorf Planet of Knowledge” – a *virtual* Eppendorf world of experience, created and constantly updated by *real* Eppendorf colleagues (p. 13).

To enable us to get in touch again personally in a not too distant future, SARS-CoV-2 research and vaccine development continue to run at full speed. Scientists around the world are struggling every day to gain new insights about vaccines and effective therapeutics.

At Eppendorf, we want to help researchers obtain reliable results by providing them with the right equipment and tools. At [www.eppendorf.com/we-care](http://www.eppendorf.com/we-care) you will find a wide range of information on product and workflow solutions for SARS-CoV-2 research.

Your Eppendorf BioNews Team

## Imprint

### Publisher

Eppendorf AG, Barkhausenweg 1,  
22339 Hamburg, Germany  
Telephone: +49 40-53801-0  
Fax: +49 40-53801-556  
E-mail: [bionews@eppendorf.de](mailto:bionews@eppendorf.de)  
[www.eppendorf.com/bionews](http://www.eppendorf.com/bionews)

### Editorial team

Berit Hoff (Editor-in-Chief),  
Dr. Jan-Hendrik Bebermeier,  
Dr. Tanja Musiol, Natascha Weiß

### Design

Holger Paulsen Grafik-Design,  
Hamburg, Germany

### Printed by

MOD Offsetdruck GmbH, Dassow,  
Germany

### Image references

All images Eppendorf AG. Exceptions:  
p. 12: PhagoMed Biopharma GmbH; p. 14  
left: Tony Luong; p. 14 right: ETH Zuerich;  
p. 24: Science/AAAS; Application Note  
p. 5–6: COS Heidelberg

### Important notes

We welcome all readers' articles for this publication. However, no responsibility is accepted for unsolicited manuscripts. The new products described may be launched at different times in various countries. Please contact your local Eppendorf organization or distributor for details.

Technical specifications subject to change.  
Errors and omissions excepted.

### Eppendorf worldwide

[www.eppendorf.com/contact](http://www.eppendorf.com/contact)

All rights reserved, including graphics and images. Trademark information: p. 14.  
© Copyright Eppendorf AG, January 2021.  
Carbon neutrally printed in Germany.



**IN THE SPOTLIGHT  
STRAIGHT FROM THE LAB**

**INNOVATION  
CLOSE-UP**

**NEWS/TIPS**

**SERVICE**

Does my bioreactor control system meet future demands?	4–5
Cost reduction in the cell culture lab	8
Sustainability in the lab: an on-going journey	11
Make several labs work as one – fast!	12
More coolness, for you and your samples	6
Get ready to Move It®!	13
epServices in the Eppendorf App	5
Now even more centrifuges by Eppendorf	7
By customer request: even more versatile	7
High-quality products + lower lifetime costs = Eppendorf OEM	9
Let’s talk about tomorrow!	10
Lauren Orefice & Randall Platt: Hamburg visits postponed	14
Eppendorf Planet of Knowledge: your virtual world of experience	13
Trademark information	14
Prize Competition: Win a Move It® pipette	15

**Eppendorf BioNews Application Notes**

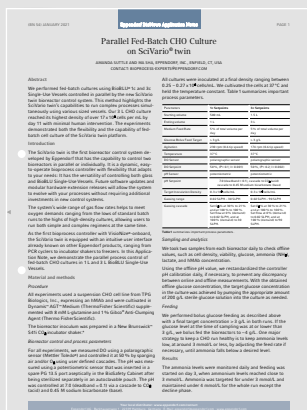

AMANDA SUTTLE, MA SHA Parallel fed-batch CHO culture on SciVario® twin	1–2
MARC-MANUEL HAHN Scalable library prep automation of AmpliSeq™ for Illumina® kits on the epMotion®	3–4
THOMAS THUMBERGER, JOACHIM WITTBRODT, SANDRA STOBRAWA Microinjection in early embryos of Zebrafish and Medaka: From transgenesis to CRISPR	5–6
SIOK-FONG CHIN, RAFAL GRZESKOWIAK Replacing glass with plastic in analytics: Comparison of UPLC spectra of samples processed in glass and Eppendorf Conical Tubes 25 mL	7–8



DAVID SOLBACH, EPPENDORF AG BIOPROCESS CENTER, JUELICH, GERMANY

# Does My Bioreactor Control System Meet Future Demands?

While the market for biologics is evolving, the drug industry is experiencing a paradigm shift from the production of blockbuster drugs to targeted, patient specific drugs. In addition, the development of new, nucleic acid-based vaccines requires a rethinking of production facilities, since significant lower production volumes will be needed. The modular bioreactor control system SciVario® twin offers the flexibility to adapt to changing requirements of modern laboratory workflows.



## Future proof equipment for changing requirements

*“A big advantage of the new controller is the sophisticated modularity of the vessel sizes that ensure an easy exchange of various bioreactor volumes without the need to invest in completely new control systems.”*

*SenseUp GmbH, Germany, Dr. Regina Mahr*

The current pandemic demonstrates how important it is to adapt rapidly and efficiently to new situations. Missing flexibility and limited workspace are

bottlenecks in the transition of a laboratory due to changing projects. Changing the focus of a laboratory results in a long list of problems. Existing bioreactor control systems might require a new hardware configuration or in the worst case need to be exchanged completely, just because they cannot handle the new demands. Designed to fit for now, and in the future, SciVario twin comes with hardware and software features that enable the system to adapt to changing processes.

The flexibility of the system can be found in every single aspect. Scaling up a process, for example, requires advanced thermal mass flow controllers (TMFCs) to ensure reliable and precise gas supply also at larger scales. Current TMFCs are optimized for either small, or larger volumes. Equipped with 14 of our in-house developed improved TMFCs, with a turn-down ratio of 12,000:1, the SciVario twin bioprocess controller can be used for both, for small- and bench-scale bioreactors with a size of 0.2 L to 3.7 L without the need of any hardware modifications. Within the near future, the vessel range will be extended to working volumes up to 40 L in single-use bioreactors for cell culture applications.

## A controller, full of innovations

SciVario twin was developed to control two single-use or glass bioreactors individually, or in parallel, in a range of 0.2 L to 40 L. It sets new standards in terms of flexibility, precision, and range. This flexibility is made possible by the advanced hardware of the base unit. In addition to the built-in TMFCs, the innovative bay-drawer concept offers the freedom to flexibly change hardware features, such as additional pumps or sensors.

With thousands of possible drawer combinations and 19 vessel variants at launch, the SciVario twin offers unrivaled flexibility for current and future processes.



### Intuitive, innovative, and intelligent

The complexity of the system does not mean that it is complicated to use.

*"The software was very easy to understand. We especially liked the fact that the UI takes one through the workflow, which helps a lot in avoiding mistakes."*

GenMab A/S, Denmark, Patrick Priem

Throughout development, our aim was to design a user friendly, easy-to-use bioprocess control system. New bioprocess controllers generally come with new software. This bears risk, because one must get familiarized with it which might lead to manual operational errors. As part of the new VisioNize® platform, the SciVario twin comes with intuitive and user-friendly VisioNize-onboard software.

The intelligent software guides the user step-by-step through the process, from the first preparation steps to the final export of the data. The software automatically recognizes the connected bioreactors and accessories and performs a consistency check. In combination with digital sensors, such as Hamilton® ARC® or Mettler Toledo ISM® sensors, the user is warned, if the used accessories do not fit, or a sensor is damaged already before the run starts.

This mitigates the risk of failures during a run and helps to save time, valuable resources, and nerves. The display is designed in a way to always keep track of both processes at the same time. Parameters of one unit can be adjusted, while the second unit runs independently.

### Remote monitoring

With VisioNize-onboard, the SciVario twin is equipped to be connected to VisioNize, Eppendorf's Digital Lab Space, delivering valuable services in and around our Eppendorf devices. Stay safely at home, remotely monitor your process, and receive notifications in case of problems.

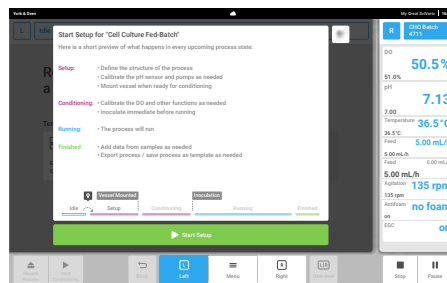

### Learn more

To learn more about the SciVario twin, please visit <http://eppendorf.global/kZx>

### Tip

## epServices in the Eppendorf App

The epServices tile in the Eppendorf App provides a full overview of our offers for

- > Maintenance & Certification
- > Technical Service
- > Seminars and Trainings
- > Application Support

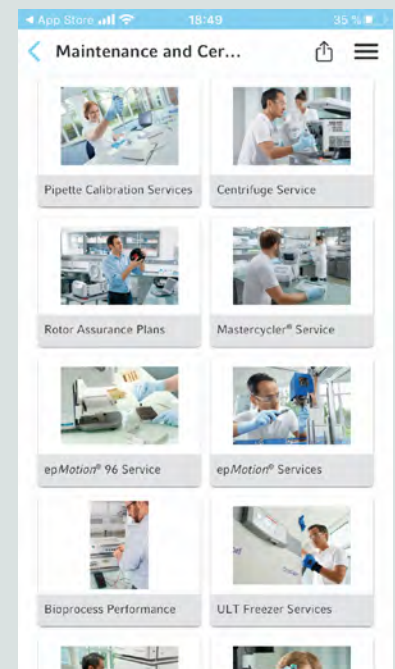

Quick and easy: Explore the Maintenance & Certification section to find the optimal service product for your Eppendorf instrument. Get compact information about product specific services:

- > Description of service scope
- > Service product variants
- > Order numbers
- > FAQs
- > Links to Service and Support pages
- > Contact button

Everything in one place – in your Eppendorf App. Download for free at <http://eppendorf.global/kZz>

FLORIAN BUNDIS, EPPENDORF AG

# More Coolness, for You and Your Samples

Many Eppendorf products have become long-term companions on which our customers can rely without question – for example, the legendary microcentrifuge 5424 R. A worthy successor, the refrigerated Centrifuge 5425 R, is now ready to step in – for more coolness, for every challenge!

It is at first glance almost indistinguishable from the Centrifuge 5424 R – both instruments share the same dimensions – but the Centrifuge 5425 R offers the following innovations and advantages.

## More applications, higher throughput

With six instead of the previous four rotors, both the versatility of application and the throughput are increased. New features include the swing-bucket rotor

for PCR-strips and divisible 96-well plates to increase your throughput, as well as the 10-place rotor for 5 mL tubes. The increased sample volume of 5 mL per tube is of particular interest when it comes to applications such as harvesting bacterial cultures and yeast cultures.

## More flexibility

Owners of an air-cooled Centrifuge 5425 can rejoice (and save) as all rotors are

interchangeable and will fit both models. The use of optionally available adapters even allows centrifugation of different tube sizes and types within the same rotor.

## Improved ergonomics

Eppendorf QuickLock® rotors can be closed with just ¼ turn. This saves time and takes repetitive stress off your wrist.

## Increased handling comfort

A bright, easy to read display, the improved short-spin function (the button no longer needs to be pushed continually) and the end-of-run display (time after rotor stopped) work together to make your daily work noticeably easier.

## Stay cool – just like your samples

The Centrifuge 5425 R is the new refrigerated 24-place standard microcentrifuge for temperature-sensitive samples. The state-of-the-art cooling technology keeps a temperature of 4°C, even at full speed – for maximum sample protection and best separation results. With a speed of up to 21,300 × g, it is perfectly suited for all modern molecular biological applications in Eppendorf Tubes® and PCR tubes.

More information at:

<http://eppendorf.global/I3E>





CORPORATE COMMUNICATIONS, EPPENDORF AG

# Even More Centrifuges by Eppendorf

Himac, with its roughly 200 centrifuge experts and premium products, is a real gain for the Eppendorf Group which, through the acquisition of this successful Japanese brand, is now expanding its centrifuge portfolio and thereby strengthening one of its core businesses in a lasting manner.



75 years ago, a mechanical engineer in Leipzig, Germany, laid the foundation for a competency center for the development and manufacturing of centrifuges that is world-renowned today. And for the past 65 years, centrifuges have been manufactured near Tokyo which have since been considered a benchmark well beyond Japan. A union between the two will give rise to a global premium vendor of separation technologies. Such was the case in the July 1, 2020 acquisition by Eppendorf of the centrifuge business of Koki Holdings Co., Ltd. of Japan, whose products are distributed under the brand name Himac.

While Eppendorf was able to continually expand its global position as a leading supplier of benchtop centrifuges in recent years, Himac focuses on floorstanding

and high-speed centrifuges as well as on clinical and automated centrifuges. With this acquisition, Eppendorf is now expanding and consolidating its centrifuge business for the pharmaceutical and life sciences sectors as well as for academic and industrial research.

“Together, we will offer our customers solutions of the highest quality while at the same time generating lasting growth perspectives for the Eppendorf Group”, explains Marlene Jentzsch, Head of Division Separation & Instrumentation at Eppendorf.

**himac**  
EPPENDORF GROUP

## Tip

## By Customer Request: Even More Versatile

Can an all-rounder become even more versatile? Yes, it can! With the **Rotor F-45-22-17** for 5 mL microcentrifuge tubes, introduced in the summer of 2020, we are fulfilling the wishes of many customers. Now with 16 rotors, the **Concentrator plus** has achieved legend status with respect to versatility. At the same time, demand for the 5 mL rotor shows that the Eppendorf Tube 5.0 mL has become firmly established in the laboratory.



### Rotor F-45-22-17

- > Capacity: 22 x Eppendorf Tubes® 5.0 mL with snap cap or screw cap
- > Vessel size: Ø17 / 59.4–67.4 mm
- > Maximum g-force: 242 x g
- > Maximum speed: 1,400 rpm
- > Maximum load: 10 g per bore (tube and sample)

### Concentrator plus

Its advanced heating technology provides best sample treatment, thereby ensuring quick, efficient, and gentle vacuum concentration of DNA/RNA, nucleotides, proteins, and other aqueous or alcohol-based samples.



Additional links to more information  
[www.eppendorf.com/concentrator](http://www.eppendorf.com/concentrator)  
[www.eppendorf.com/5mL](http://www.eppendorf.com/5mL)

CHRISTIAN HABERLANDT, EPPENDORF AG

# Cost Reduction in the Cell Culture Lab

CO<sub>2</sub> incubators are standard equipment in every cell culture lab. Running costs for a CO<sub>2</sub> incubator can easily exceed its purchase price over time, and they represent a significant cost factor. The following five factors, questions, and recommendations should be considered carefully before making a purchasing decision for your next CO<sub>2</sub> incubator.

## 1. Future flexibility: adapting to changing needs and experimental setups

Will it become necessary to rearrange your cell culture lab or move it to a new location within the incubator's lifetime? How about new experimental designs like hypoxic conditions or in-incubator experiments? Ask the manufacturer for in-field upgrade possibilities such as, for example, changeable door handle position, O<sub>2</sub> control, or segmented inner doors.

## 2. Gas consumption: CO<sub>2</sub> and N<sub>2</sub>

Every time you open the incubator door, gases escape, and the chamber needs to be refilled after closing. The more often and the longer the door is opened in a busy lab, the more CO<sub>2</sub> (and sometimes even costly N<sub>2</sub>) is consumed. Ask the manufacturer for gas consumption data, calculate the costs over time with your local gas prices, and consider the necessary gas cylinder change frequency. Especially for N<sub>2</sub>, cost differences can easily exceed the purchase price in less than five years.

## 3. Vessel capacity: usable space vs. used lab space (footprint)

Due to interior parts (e.g. fan, air ducts, HEPA-filters) and other technological features, the theoretical volume (e.g. 170 L class) is not equal to the actual usable space. Compare the actual number of vessels you can fit into the CO<sub>2</sub> incubator you consider buying.

## 4. Risk of lab downtime, potential sample loss, and maintenance efforts: contamination prevention concept

How long does it really take to disassemble and clean the incubator? Are heat-sensitive HEPA filter cartridges required that need to be removed before starting a 180 °C disinfection cycle, and does their re-installation involve extended door opening and reaching all the way to the back of the clean chamber?

## 5. Expendable parts: regular replacement of HEPA-filters and UV lamps

Some CO<sub>2</sub> incubators utilize fan-associated HEPA-filters that need to be replaced twice yearly to provide unobstructed airflow and atmosphere accuracy. Have the manufacturer calculate the costs for expendable parts over the lifetime of the CO<sub>2</sub> incubator as they can easily add up to several thousands of €.

CellXpert CO<sub>2</sub> incubator

## Cost reduction is important to you?

Discover the new CellXpert® CO<sub>2</sub> incubator that helps you significantly reduce costs for your cell culture lab by up to 8,300 € over five years. Find more <http://eppendorf.global/11Q>



# Parallel Fed-Batch CHO Culture on SciVario® twin

AMANDA SUTTLE AND MA SHA, EPPENDORF, INC., ENFIELD, CT, USA  
CONTACT: BIOPROCESS-EXPERTS@EPPENDORF.COM

## Abstract

We performed fed-batch cultures using BioBLU® 1c and 3c Single-Use Vessels controlled in parallel by the new SciVario twin bioreactor control system. This method highlights the SciVario twin’s capabilities to run complex processes simultaneously using various sized vessels. Our 3 L CHO culture reached its highest density of over  $17 \times 10^6$  cells per mL by day 11 with minimal human intervention. The experiments demonstrated both the flexibility and the capability of fed-batch cell culture of the SciVario twin platform.

## Introduction

The SciVario twin is the first bioreactor control system developed by Eppendorf that has the capability to control two bioreactors in parallel or individually. It is a dynamic, easy-to-operate bioprocess controller with flexibility that adapts to your needs: It has the versatility of controlling both glass and BioBLU Single-Use Vessels. Future software updates and modular hardware extension releases will allow the system to evolve with your processes without requiring additional investments in new control systems.

The system’s wide range of gas flow rates helps to meet oxygen demands ranging from the lows of standard batch runs to the highs of high-density cultures, allowing users to run both simple and complex regimens at the same time.

As the first bioprocess controller with VisioNize®-onboard, the SciVario twin is equipped with an intuitive user interface already known on other Eppendorf products, ranging from PCR cyclers to incubator shakers to freezers. In this Application Note, we demonstrate the parallel process control of fed-batch CHO cultures in 1 L and 3 L BioBLU Single-Use Vessels.

## Material and methods

### Procedure

All experiments used a suspension CHO cell line from TPG Biologics, Inc., expressing an hMAb and were cultivated in Dynamis™ AGT™ Medium (ThermoFisher Scientific) supplemented with 8 mM L-glutamine and 1 % Gibco® Anti-Clumping Agent (Thermo Fisher Scientific).

The bioreactor inoculum was prepared in a New Brunswick™ S41i CO<sub>2</sub> incubator shaker.\*

### Bioreactor control and process parameters

For all experiments, we measured DO using a polarographic sensor (Mettler Toledo®) and controlled it at 50 % by sparging air and/or O<sub>2</sub> using user defined cascades. The pH was measured using a potentiometric sensor that was inserted in a spare PG 13.5 port aseptically in the BioSafety Cabinet after being sterilized separately in an autoclavable pouch. The pH was controlled at 7.0 (deadband = 0.1) via a cascade to CO<sub>2</sub> (acid) and 0.45 M sodium bicarbonate (base).

All cultures were inoculated at a final density ranging between  $0.25 - 0.27 \times 10^6$  cells/mL. We cultivated the cells at 37°C and held the temperature constant. Table 1 summarizes important process parameters.

Parameters	1c Setpoints	3c Setpoints
Starting volume	500 mL	1.5 L
Ending volume	1 L	3 L
Medium Feed Rate	5 % of total volume per day	5 % of total volume per day
Glucose Bolus Feed Target	> 3 g/L	> 3 g/L
Agitation	230 rpm (0.6 tip speed)	174 rpm (0.6 tip speed)
Temperature	37°C	37°C
DO Sensor	polarographic sensor	polarographic sensor
DO Setpoint	50 %, (P= 0.1; I= 0.001)	50 %, (P= 0.2; I= 0.002)
pH Sensor	potentiometric	potentiometric
pH Setpoint	7.0 (deadband = 0.1), cascade to CO <sub>2</sub> (acid) cascade to 0.45 M sodium bicarbonate (base)	
Target Inoculation Density	$0.3 \times 10^6$ cells/mL	$0.3 \times 10^6$ cells/mL
Gassing range	0.02 SLPH – 30 SLPH	0.02 SLPH – 90 SLPH
Gassing cascade	Set O <sub>2</sub> % at 30 % to 21 % and at 100 % to 100 %. Set flow at 0 % (demand) to 0.02 SLPH, and at 100 % (demand) to 30 SLPH.	Set O <sub>2</sub> % at 30 % to 21 % and at 100 % to 100 %. Set flow at 0 % (demand) to 0.02 SLPH, and at 100 % (demand) to 90 SLPH.

Table 1 summarizes important process parameters.

## Sampling and analytics

We took two samples from each bioreactor daily to check offline values, such as cell density, viability, glucose, ammonia (NH<sub>3</sub>), lactate, and hMAb concentration.

Using the offline pH value, we restandardized the controller pH calibration daily, if necessary, to prevent any discrepancy between online and offline measurements. With the obtained offline glucose concentration, the target glucose concentration in the culture was achieved by pumping the appropriate amount of 200 g/L sterile glucose solution into the culture as needed.

## Feeding

We performed bolus glucose feeding as described above with a final target concentration > 3 g/L in both runs. If the glucose level at the time of sampling was at or lower than 3 g/L, we bolus fed the bioreactors to ~4 g/L. One major strategy to keep a CHO run healthy is to keep ammonia levels low, at around 3 mmol/L or less, by adjusting the feed rate if necessary, until ammonia falls below a desired level.

## Results

The ammonia levels were monitored daily and feeding was started on day 3, when ammonium levels reached close to 3 mmol/L. Ammonia was targeted for under 3 mmol/L and maintained under 4 mmol/L for the whole run except the decline phase.

## Parallel Fed-Batch CHO Culture on SciVario® twin

The BioBLU 1c reached a peak density of  $13.8 \times 10^6$  cells/mL on day 13 (Fig. 1A) and peak antibody production of 682 mg/L on day 15 (Fig. 1B), while the BioBLU 3c reached a peak density of  $17.4 \times 10^6$  cells/mL on day 11 (Fig. 2A) and peak antibody production of 776 mg/L on day 15 (Fig. 2B). The metabolic profile for the BioBLU 1c and 3c runs are displayed in Fig. 1B and 2B, respectively.

### Discussion and conclusions

With the SciVario twin, we were able to achieve high yields running fed-batch CHO cultures using 1 L and 3 L vessels in parallel, with our highest yields reaching almost  $18 \times 10^6$  cells/mL.

The SciVario twin has the capabilities to operate multiple processes using different sized vessels at the same time, making it an extremely versatile bioprocess controller. Its ability to operate both glass and single-use bioreactors makes it easy to switch between single-use and autoclavable equipment depending on process needs.

With the integrated VisioNize-onboard software, the controller enables the easy monitoring and control of both processes at the same time. Intelligent wizards mitigate the risk of failures during the process. At initial release, the SciVario twin will support up to 4 L cultures. With future Agile release train updates, processes up to 40 L will be supported. It is the first bioprocess controller to consolidate the operation of Eppendorf small-scale and bench-scale vessels, with parallel operations delivering unparalleled value to the customers. The range of vessel sizes supported will continue to expand and evolve with customers' needs, ensuring that SciVario twin will continue to deliver value far into the future.

\*For more details download Application Note 432 at <http://eppendorf.global/122>

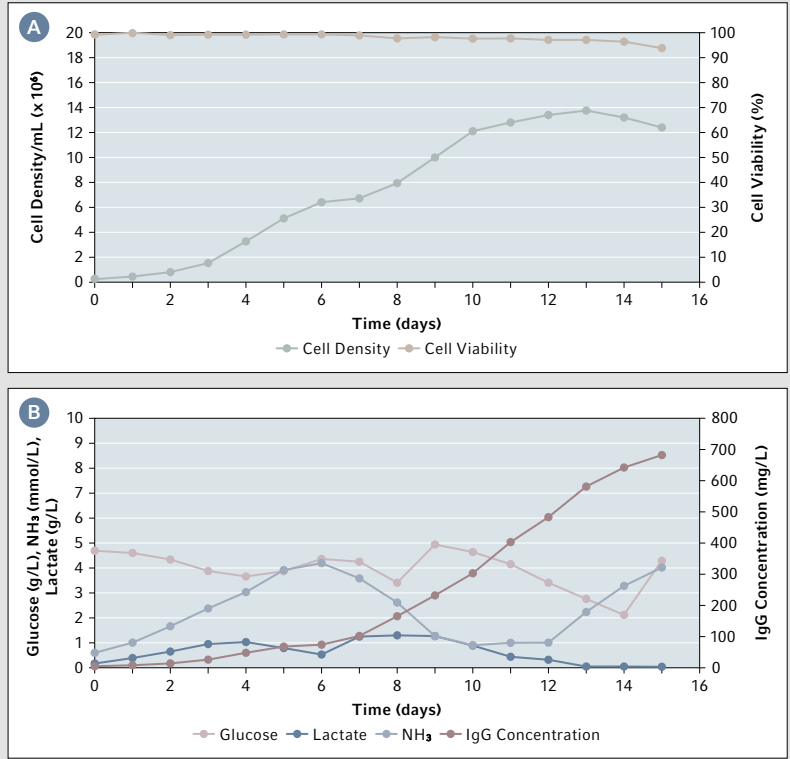

Fig. 1: BioBLU 1c – Cell growth, antibody production and metabolic profile  
 A: Total viable cells/mL throughout the 1c fed-batch run  
 B: The antibody production and metabolic profile

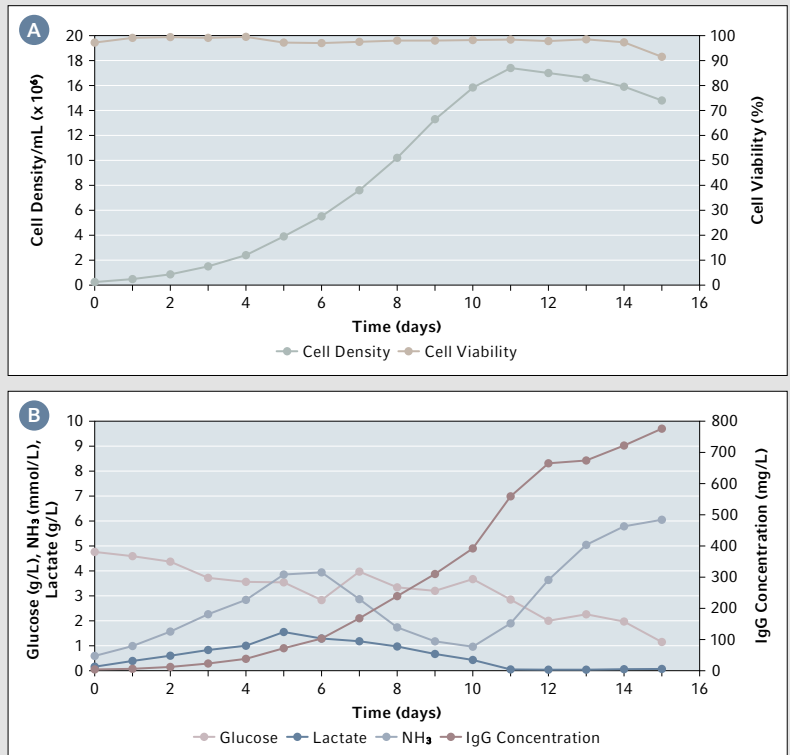

Fig. 2: BioBLU 3c – Cell growth, antibody production and metabolic profile  
 A: Total viable cells/mL throughout the 3c fed-batch run  
 B: The antibody production and metabolic profile

# Scalable Library Prep Automation of AmpliSeq™ for Illumina® Kits on the epMotion®

CONTACT: MARC-MANUEL HAHN, EPPENDORF AG, HAMBURG, GERMANY  
(HAHN.M@EPPENDORF.DE)

Due to the growing number of relevant genes and variants, next generation sequencing (NGS) has become a standard technique in the field of cancer research and molecular pathology. AmpliSeq panels for Illumina have been introduced to study the growing number of interesting variants in an increasing number of relevant genes. In theory, library preparation with such panels promises the ability to query many interesting loci in the genome and their transcription on isolates from a broad range of specimens, including blood, cell culture, and formalin-fixed paraffin-embedded (FFPE) tissue at low efforts. However, working with the latter materials can represent practical challenges that require robust and established workflows for analytical studies. Here we summarize workflows for this purpose using automated liquid handling for library preparation for the AmpliSeq Focus panel on the epMotion system, which can accommodate both RNA and DNA samples in a single automated setup [1, 2, 3]. We discuss the scalability of this solution on the epMotion 5075t NGS solution and 5073m NGS solution systems.

## AmpliSeq Focus Panel for Illumina

This targeted resequencing solution for a wide range of sample types, including FFPE tissue and low sample input [2], is particularly suited for comparisons as it analyzes single nucleotide variants (SNVs), RNA fusion transcripts, and DNA copy number variants [2].

## Workflows on the 5075t NGS solution and 5073m NGS solution

Fig. 1 shows a summary of an optimized automated workflow that was tested with more than 128 library preparations [1, 2, 3]. These approaches can work well with established references, such as Horizon™ DNA standards and SeraSeq® Fusion RNA Mix v3 [1] and with more degraded material from FFPE samples [2]. With the AmpliSeq Focus panel workflow, we have illustrated Eppendorf’s scalable solution to easily and reliably

automate the construction of NGS libraries and match these to the respective sequencer throughputs. This allows the automated processing of up to 48 samples on the epMotion 5075t NGS solution and 16 samples on the epMotion 5073m NGS solution with the AmpliSeq Focus panel [1]. PCR amplifications are performed off-deck on the Mastercycler® X50 (Eppendorf).

For labs with lower throughputs, we established an automated workflow on the epMotion 5073m NGS solution that can accommodate up to 16 samples. We further recently demonstrated that by incorporating the equalizer chemistry, automated sample preparation reduces the hands-on time by nearly 50 % [4].

## Outlook

These panel workflows stand as examples for further AmpliSeq workflows with either the DNA or RNA as input material of the sample processing route. Given that the automated library prep solution can be scaled to the throughput, with the epMotion NGS solutions, Eppendorf provides reliable and attractive companions for different sequencers. Table 1 exemplifies how different epMotion systems can provide the required flexibility to produce the matching number of libraries for different bench top sequencers. The flexibility and scalability of this approach may aid in the routine study of different samples and throughputs, while reducing hands-on time.

Table 1: Matching automation platform for different sequencers. Depending on the coverage, panels of different sizes can be accommodated on different sequencers. For this a coarse division between different platforms can be made [5]. As this is proportional to the number of primer pools per panel (DNA and RNA) this definition can be further divided for the epMotion 5073m and 5075t NGS platforms to match that number of samples per sequencer, where the limiting variable is the number of PCR reactions (for each primer pool) that can be prepared on the liquid handler [1].

	iSeq™ 100	MiniSeq™	MiSeq™	NextSeq™
<b>epMotion® 5073</b> (for up to 32 reactions*)	> Focus Panel (8 samples) > BRCA Somatic (12 samples) > Cancer Hotspot (16 samples)	> Immune Response (24 samples) > Immune Repertoire (24 samples)	> Immune Response (24 samples) > Immune Repertoire (24 samples)	> No kits specified
<b>epMotion® 5075</b> (for up to 96 reactions*)	> BRCA Germline (96 samples)	> Focus Panel (48 samples) > BRCA Somatic (80 samples) > Cancer Hotspot (96 samples) > BRCA Germline (96 samples) > Germline (96 samples) > Myeloid Panel (24 samples)	> Focus Panel (48 samples) > BRCA Somatic (80 samples) > Cancer Hotspot (96 samples) > BRCA Germline (96 samples) > Germline (96 samples) > Myeloid Panel (24 samples)	> Comprehensive Cancer (12 samples) > Exome (8 samples) > Transcriptome (40 samples) > Comprehensive v3 (48 samples)

\*This is roughly illustrated in the table based on 96 total PCR reactions divided on the different pools per kit for the epMotion 5075 NGS solution and 32 total PCR reactions for the 5073m NGS solution. For example, the focus panel features 1 DNA and 1 RNA primer pool, that thus allows the preparation of up to 16 samples on the epMotion 5073m and 48 samples on the epMotion 5075t, respectively matching iSeq and MiSeq throughputs.



## Scalable Library Prep Automation of AmpliSeq™ for Illumina® Kits on the epMotion®

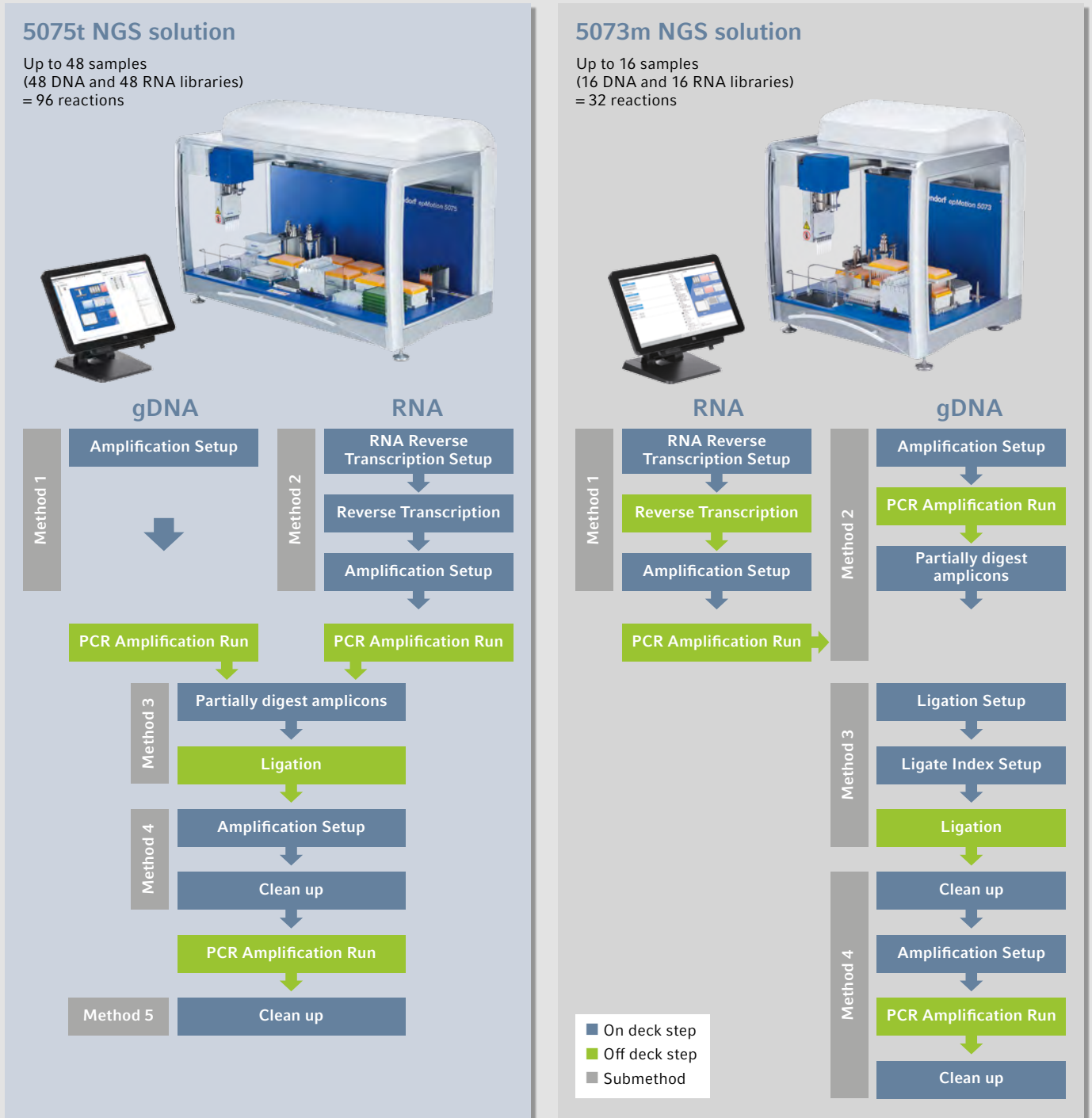

**Fig. 1:** Overview of the automated workflow for the AmpliSeq Focus Panel for Illumina on the epMotion. Grey boxes = submethods; blue boxes = "on deck" steps (processed on the epMotion); green boxes = steps performed "off deck". PCR amplifications were performed on the Mastercycler X50. In alignment with the protocol, workflows are compartmented into logical units. See [1] for detailed run times and consumable usage.

### Literature

[1] Scalable Library Prep Automation of AmpliSeq™ for Illumina® Kits on the epMotion®. <http://eppendorf.global/le8>

[2] Illumina: Analytical performance of the AmpliSeq™ for Illumina Focus Panel with FFPE samples. <https://bit.ly/2QFTRKc>

[3] Protocol: Flexible Library Preparation for Your Cancer Research Lab –

Automate AmpliSeq™ for Illumina® Kits on the epMotion®. <http://eppendorf.global/lea>

[4] M. Hahn, V. Montel, N. Mouttham, E. Ganczarek, S. Hamels, U. Wilkening, J. Tsai: Poster at the European Human Genetics Virtual Conference ESHG 2020.2: P12.009.B – Establishing a scalable automation approach with the epMotion and AmpliSeq for Illumina.

[5] AmpliSeq for Illumina. Sequencing amplified. [www.illumina.com](http://www.illumina.com)

# Microinjection in Early Embryos of Zebrafish and Medaka: from Transgenesis to CRISPR

THOMAS THUMBERGER AND JOACHIM WITTBRODT, CENTRE FOR ORGANISMAL STUDIES (COS) HEIDELBERG, HEIDELBERG UNIVERSITY, GERMANY  
SANDRA STOBRAWA, EPPENDORF AG, HAMBURG, GERMANY

## Introduction

Teleost fish such as the Japanese rice fish medaka or zebrafish are widely used vertebrate model organisms (Wittbrodt, 2002; Fig. 1).

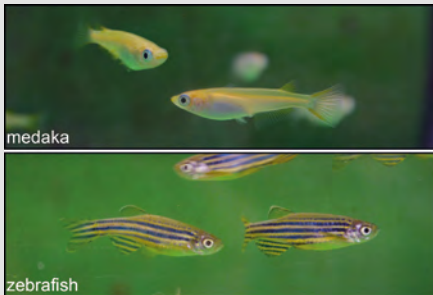

Fig. 1: Adult medaka (*Oryzias latipes*) and zebrafish (*Danio rerio*)

Many benefits such as high reproduction rate paired with short generation times, transparency of chorion and embryo facilitate non-invasive *in vivo* imaging over longer periods of time. The availability of various genetic tools makes them widely used model organisms for developmental, genetic, and molecular studies. Moreover, the high efficiency of genome-editing by CRISPR/Cas9 renders both very attractive to generate knock-out lines (Stemmer, 2015) and especially in medaka also to perform precise genetic modifications like tagging genes of interest with fluorescent markers (Gutierrez-Triana, 2018). The following describes the microinjection procedure for targeted knock-out and knock-in using the InjectMan® 4 and FemtoJet® 4 (Eppendorf), allowing for the efficient and rapid injection of hundreds of fish zygotes.

## Methods

It is advisable to inject fish embryos at the one-cell stage and thus adjust the timing of mating and collection. For injection, the zygotes are transferred into the trenches of an agarose injection plate under a stereomicroscope.

For CRISPR/Cas9 knock-out and knock-in design find good sgRNA target sites (low predicted off-targets) using a computational sgRNA design tool.

## CRISPR/Cas9 knock-out and knock-in mix:

- > 150 ng/μL Cas9 mRNA
- > 15 ng/μL per sgRNA
- > (5 ng/μL biotinylated PCR donor – for knock-in attempts)
- > ad 10 μL nuclease free water

For zebrafish injections use microcapillaries, e.g. Femtotips® II (Eppendorf), with a long and thin tapered tip end of approx. 0.5 μm opening. The capillary for medaka injections must have a slightly stronger tip end with a shorter, non-flexible taper allowing to penetrate the stiff chorion. Load 2–5 μL of the supernatant of a freshly centrifuged injection mix into the microcapillary.

Mount the capillary on the capillary holder of the FemtoJet 4i which is mounted onto the InjectMan 4 in a 45° angle. Both devices are connected via the interface cable to allow semi-automatic injections. For the FemtoJet 4i

microinjector, recommended starting settings are 500–700 hPa for injection pressure (pi) and 80–100 hPa for compensation pressure (pc). The optimal injection time must be determined empirically. Medaka embryos needed to be oriented in the agarose trench with the embryonic cell atop of the yolk to inject into it. Zebrafish can be injected into the yolk sac.

Move the microcapillary down to the embryo in the injection plate using the joystick of the micromanipulator and holding the dish in place with your opposite hand. Bring the microscopic focus on the thinnest region of the tip close to the egg. Pierce the chorion surface with the capillary tip and enter the capillary either into the embryonic cell (medaka, see Fig. 2A) or into the yolk sac close to the embryonic cell (zebrafish, see Fig. 2B) in one smooth stroke using the axial movement mode.

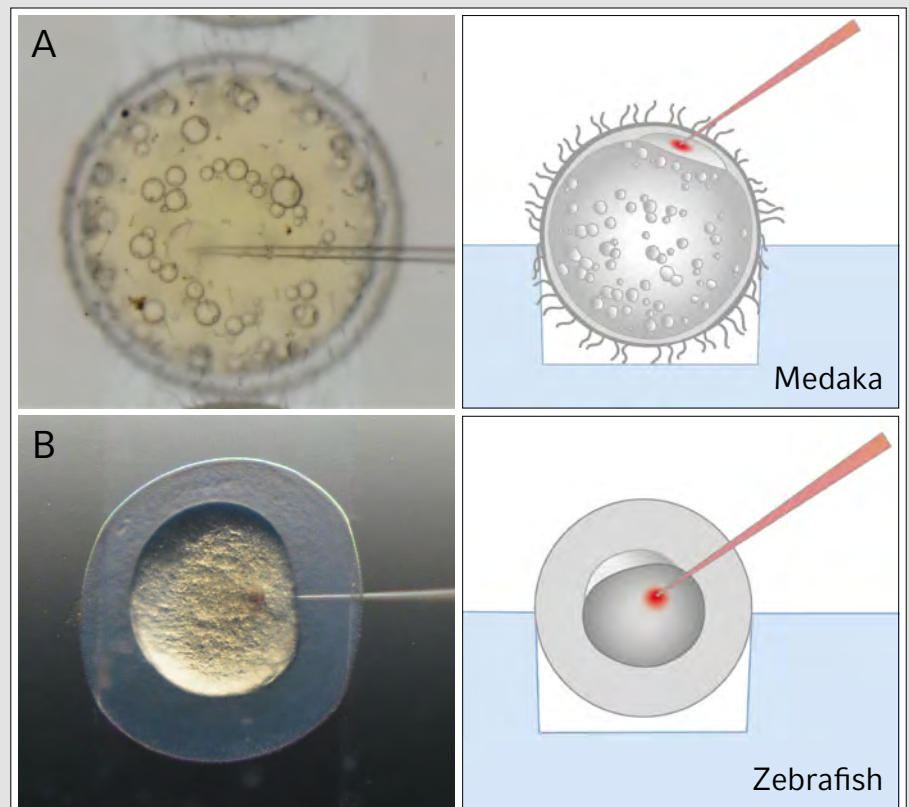

Fig. 2: Microinjection into the cytoplasm of the medaka one-cell stage (A) or into the yolk sac of the one-cell stage embryo of zebrafish (B).

## Microinjection in Early Embryos of Zebrafish and Medaka: from Transgenesis to CRISPR

Trigger the injection pressure by pressing the joystick button. The injection is triggered until you see a droplet of 10–15% of the embryonic cell volume. Then retract the capillary out of the egg with same injection angle. Move the dish manually to position the next zygote close to the capillary tip in the microscopic focus and repeat the injection. In high-throughput routine it is also possible to use the semi-automatic injection mode for zebrafish injection.

Injected embryos are transferred to a dish with appropriate rearing media and kept at 26 °C (medaka) or 28 °C (zebrafish) until hatching. Replace the embryo rearing medium periodically to reduce the risk of infection.

### Results

The day after injection, sort the embryos for proper development and according to expected phenotype or expression. Depending on the injection mix, embryos may survive less than non-injected siblings. However, as injections are easily performed with an electronic microinjection system, a huge number of modified embryos can be generated. This is particularly relevant for CRISPR-mediated knock-out or knock-in attempts that do not yield an obvious phenotype. In such cases, PCR genotyping is required on a subset of injected embryos. To illustrate the typical results of microinjections, we used the above protocol to successfully generate a CRISPR/Cas9-mediated knock-out of the eye pigmentation gene *oca2* (*oculocotaneous albinism 2*) in medaka and zebrafish (see Hammouda, 2019; Fig. 3 A–C) and an in-frame knock-in approach of the *gfp* sequence with the endogenous *rx2* (*retina-specific homeobox gene 2*) gene in medaka (see Gutierrez-Triana, 2018; Fig. 3D).

### Discussion

One of the strengths of fish model systems is the simplicity with which certain gene products can be added to or removed from the embryo by microinjection. In combination with the CRISPR/Cas system, the intuitive and convenient operation of reliable micromanipulation systems such as the Eppendorf InjectMan 4 and FemtoJet 4 is a perfect

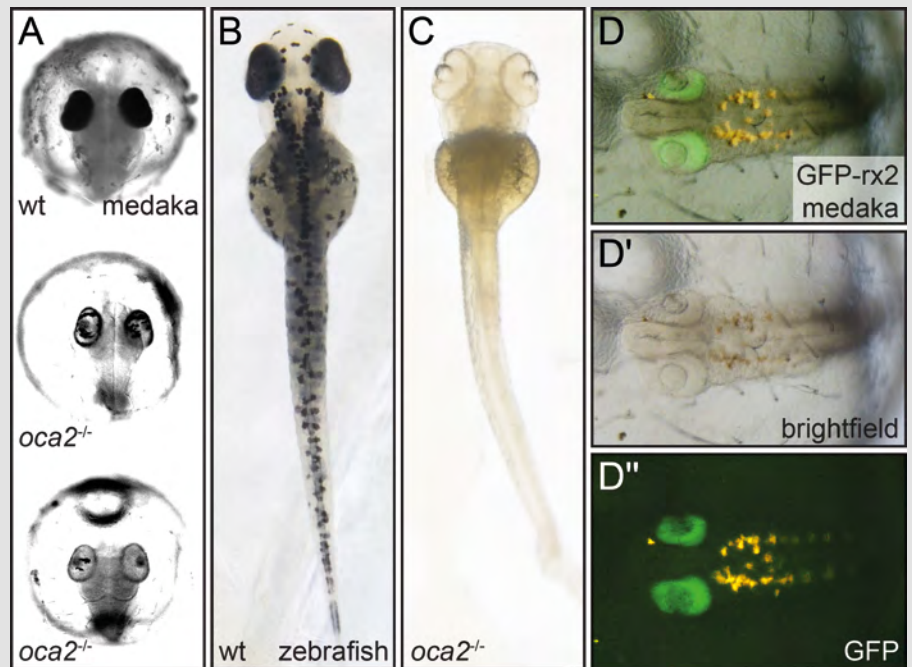

**Fig. 3:** Successful genome editing in the injected generation. *Oca2* crispants in medaka (A) and zebrafish (B, C) showing loss of pigmentation (predominant in the retinal pigmented epithelium of the eye, as well as in body pigmentation) in comparison to pigmented wildtypes (wt).

Mosaicism in pigmentation (A) is caused by the fact that the NHEJ repair machinery leads to random insertion/deletions at the introduced double strand break which may still yield a functional allele in some cells. (D) GFP fluorescence in the retina of developing medaka upon HDR-mediated tagging of the *rx2* gene.

match to perform both simple and high-throughput knock-out screens on a large number of embryos with little effort and time. Especially for zebrafish, the option for semi-automatic injection steps facilitates the efficient and fast injection of hundreds of fish zygotes.

### Literature

Wittbrodt J, Shima A, Schartl M. Medaka – a model organism from the far East. *Nat Rev Genet.* 2002; 3(1): 53-64. Review.

Stemmer M, Thumberger T, Del Sol Keyer M, Wittbrodt J, Mateo JL. CCTop: An Intuitive, Flexible and Reliable CRISPR/Cas9 Target Prediction Tool. *PLoS One.* 2015; 10(4): e0124633.

Gutierrez-Triana JA, Tavhelidse T, Thumberger T, Thomas I, Wittbrodt B, Kellner T, Anlas K, Tsingos E, Wittbrodt J. Efficient single-copy HDR by 5' modified long dsDNA donors. *eLife.* 2018; 7: e39468.

Hammouda OT, Böttger F, Wittbrodt J, Thumberger T. Swift Large-scale Examination of Directed Genome Editing. *PLoS One.* 2019; 14(3): e0213317.

For additional information, download the full-length Application Note 430 at <http://eppendorf.global/176>



# Replacing Glass with Plastic in Analytics: Comparison of UPLC Spectra of Samples Processed in Glass and Eppendorf Conical Tubes 25 mL

SIOK-FONG CHIN, UKM MEDICAL MOLECULAR BIOLOGY INSTITUTE (UMBI),  
UNIVERSITI KEBANGSAAN MALAYSIA, KUALA LUMPUR, MALAYSIA  
RAFAL GRZESKOWIAK, EPPENDORF AG, HAMBURG, GERMANY

## Introduction

Materials commonly used in medical and life-science lab consumables are typically a blend of base polymers with a broad and heterogenous range of chemicals added during production. These substances facilitate or accelerate the processability of the polymer, prolong its long-term stability or enhance its performance in the end product in various ways. Increasing scientific evidence indicates however, that substantial part of those processing additives may be released (leach) into samples and significantly affect experiments. Ultimately, they may pose a likely and largely underestimated source of error in analytical and life-science assay systems [1, 2].

Highly sensitive analytical workflows like GC, HPLC or MS are particularly prone to negative influence of leaching and glassware remains a mainstay as golden standard in most analytical methods. Glassware has however its natural drawbacks (low mechanical stability, cost, safety and cleaning issues) and the need to replace it by comparably leaching-free plastic consumables is high.



In this Application Note, high-quality polypropylene tubes (Eppendorf Conical Tubes 25 mL) were used to substitute glass vessels in a standard analytical workflow: UPLC-UV measurement and routine analysis of serum 25OHD<sub>2</sub> and 25OHD<sub>3</sub> levels [3]. No interfering peaks from typical polypropylene leachables were observed. Substituting glassware with polypropylene tubes allowed substantial time saving, reduced waste and hazard risk without compromising the chromatography quality.

## Material and methods

### UPLC analysis of 25-hydroxyvitamin D<sub>2</sub> and 25-hydroxyvitamin D<sub>3</sub> in human serum

For detailed method description refer to: Chin SF, Osman J, Jamal R. Simultaneous determination of 25-hydroxyvitamin D<sub>2</sub> and 25-hydroxyvitamin D<sub>3</sub> in human serum by ultra-performance liquid chromatography: An economical and validated method with bovine serum albumin. *Clinica Chimica Acta*. October 2018; 485: 60-66.

**Short summary:** Simultaneous determination of human serum 25-hydroxyvitamin D<sub>2</sub> (25OHD<sub>2</sub>) and 25-hydroxyvitamin D<sub>3</sub> (25OHD<sub>3</sub>) was performed using Ultra Performance Liquid Chromatography (UPLC). Non-human matrix of 4% BSA was used to construct the calibration curve and in quality control samples' preparation to avoid interference of the endogenous 25-hydroxyvitamin D (25OHD) present in the human serum. 25OHD<sub>2</sub>, 25OHD<sub>3</sub> and dodecanophenone (internal standard, IS) were separated on a CORTECS solid-core particle column (Waters™) and monitored by a photodiode array detector at a wavelength of 265 nm within five min run time.

The relationship between 25OHD concentration and peak area ratio (25OHD:IS) was linear over the range of 12.5–200 nM with mean correlation coefficients ( $r^2$ ) > 0.998. The limit of detection (LOD) for 25OHD<sub>2</sub> and 25OHD<sub>3</sub> was 3.00 nM and 3.79 nM, while the lower limit of quantification (LLOQ) was 9.11 nM and 11.48 nM, respectively. High repeatability was obtained for both isomers with intra-day CV % < 5.6 % and < 5.3 % for inter-day assay. This method was further tested with a commercial lyophilized serum control with an accuracy of 92.87–108.31 % and applied on 214 human serum samples. In summary, this validated method with BSA can be reliably applied for routine quantification of 25OHD in adults.

## Results and discussion

The results indicate that comparable UPLC-UV separation and elution peaks were detected when using Eppendorf Conical Tubes 25 mL as compared to standard borosilicate glass tubes. No interfering peaks from leachables, even at very low noise values, were observed.

Substituting glassware with polypropylene tubes in the described liquid chromatography workflow saved time and reduced waste and hazard risk without compromising the chromatography quality.

## Conclusions

In this Application Note, high-quality polypropylene tubes (Eppendorf Conical Tubes 25 mL) were used to substitute glass tubes in standard analytical workflow routine UPLC-UV analysis of serum 25OHD<sub>2</sub> and 25OHD<sub>3</sub> levels. Comparable UPLC separation and elution peaks were detected when using

## Replacing Glass with Plastic in Analytics: Comparison of UPLC Spectra of Samples Processed in Glass and Eppendorf Conical Tubes 25 mL

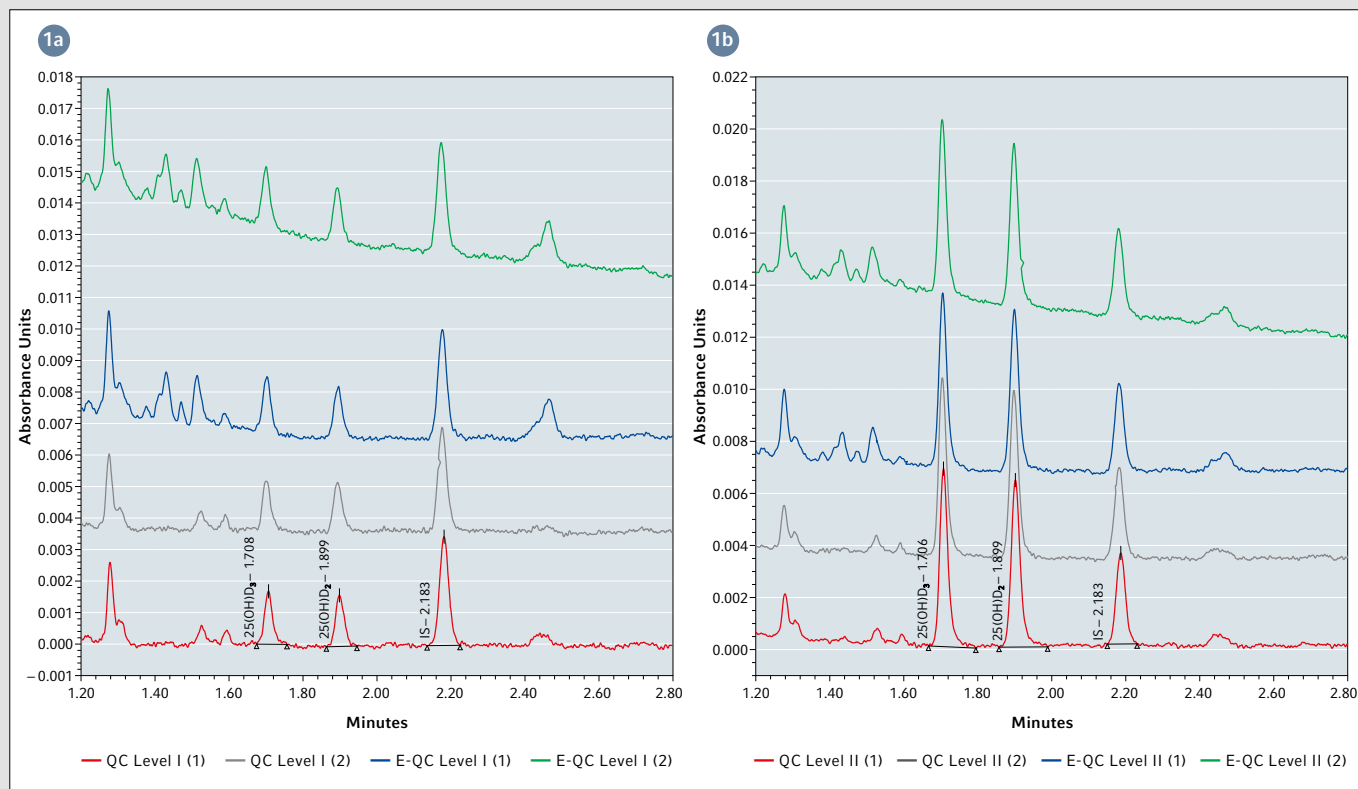
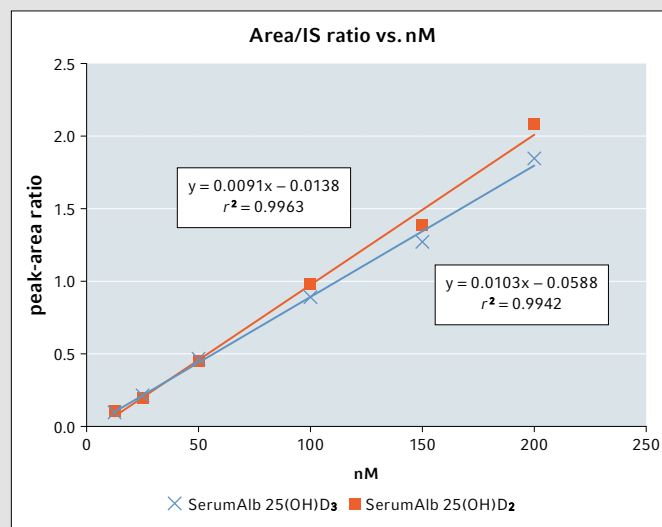

**Fig. 1:** UPLC-UV spectra of 25-hydroxyvitamin D<sub>2</sub> and 25-hydroxyvitamin D<sub>3</sub> in human serum obtained using borosilicate glass (QC, red and grey curves) and polypropylene Eppendorf Conical Tubes 25 mL (E-QC blue and green curves). Two levels of detection are shown: **Fig. 1a:** low (Level I) and **Fig. 1b:** high (Level II). Each acquisition was performed in duplicates (spectra 1 and 2).

Eppendorf Conical Tubes 25 mL as compared to standard borosilicate glass tubes. No interfering peaks from possible UV-absorbing leachables, even at very low noise values, were observed. Substituting glassware with polypropylene tubes in the described liquid chromatography workflow saved time (glassware cleaning) and reduced waste and hazard risk without compromising the chromatography quality.

### Literature

- [1] Schauer KL, et. al. Mass Spectrometry Contamination from Tinuvin 770, a Common Additive in Laboratory Plastics. *Journal of Biomolecular Techniques*. July 2013; 24(2):57-61
- [2] Grzeskowiak R, Gerke N. Leachables: Minimizing the Influence of Plastic Consumables on the Laboratory Workflows. *Eppendorf White Paper 026*. <http://eppendorf.global/I2d>
- [3] Chin SF, Osman J, Jamal R. Simultaneous determination of 25-hydroxyvitamin D<sub>2</sub> and 25-hydroxyvitamin D<sub>3</sub> in human serum by ultra-performance liquid chromatography: An economical and validated method with bovine serum albumin. *Clinica Chimica Acta*. October 2018; 485: 60-66



**Fig. 2:** Correlation of peak-area ratios of 25(OH)D<sub>3</sub> and 25(OH)D<sub>2</sub>, respectively to dodecaphenone (IS) with 25OHD concentrations. The six-point calibration curves were linear over the range of 12.5–200 nM with mean correlation coefficients ( $r^2$ ) > 0.994. All QC samples with known concentration were quantified against the calibration curve to assess the validity of the experiment.

MAIKE KNIPPELMEYER, EPPENDORF AG

# High-Quality Products + Lower Lifetime Costs = Eppendorf OEM

Design changes to an existing product can have a big impact on the success of numerous established applications in diagnostics and life science research. In some cases, an OEM (original equipment manufacturer) custom solution can overcome the limitations of existing designs and even make new assays and analyses possible. Finding a reliable OEM partner is essential to ensure stability, create a long-term partnership, and ultimately reduce the total cost of ownership. Eppendorf OEM's experienced, interdisciplinary team of experts delivers high-quality custom products.

Designing customized plates, pipette tips, tubes, pipetting workstations for life science research, or instruments for use in diagnostic applications requires a knowledgeable team with years of experience in the research and development of laboratory instrumentation and consumables. Eppendorf OEM has an experienced and interdisciplinary development team, as well as the necessary infrastructure to support testing and production.

Eppendorf OEM also adheres to high production standards including ISO 13485 and ISO 9001. The combination of premium quality control standards, state-of-the-art production technology, high purity and precision, and both mechanical and manual testing ensures high-quality products.

The Eppendorf OEM team is capable of modifying polymer surfaces according to a customer's specific needs. Some examples include: smoothing the surface to reduce liquid retention and preserve valuable samples and reagents; using plasma treatment to improve cell attachment in various plates; adapting raw pellet material via crystallization to create more robust and durable consumables; and even changing the structure of injection molding tools to create a rough plastic surface to repel liquids.

Eppendorf also takes accountability a step further by manufacturing all products in their own semi- and fully automated production facilities with environmentally controlled cleanrooms, where necessary,

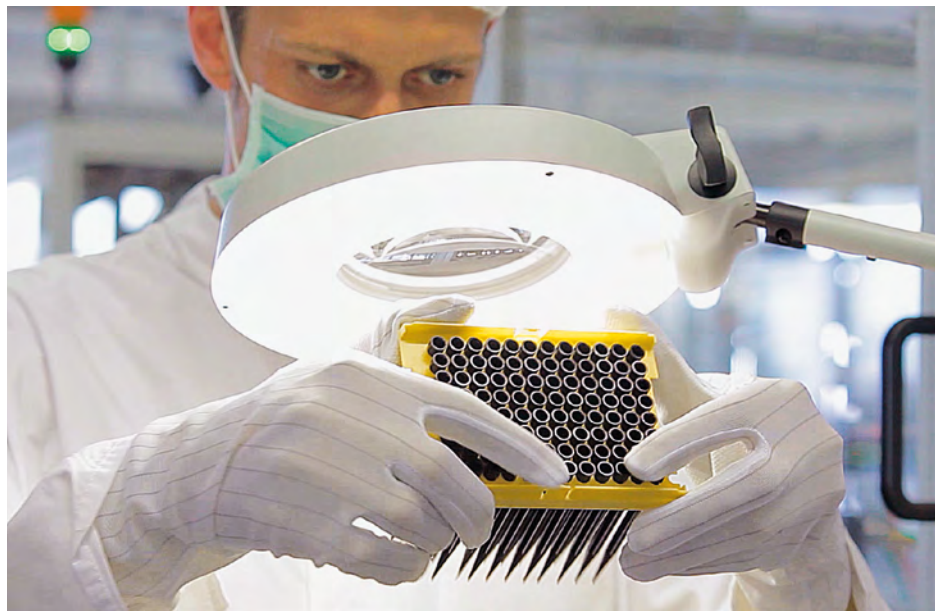

Eppendorf OEM – your partner for sophisticated custom solutions

in the United States and Germany. Further, with multiple central distribution centers, customers can rest assured their product will be delivered in time worldwide.

A reliable OEM partner is essential to ensure high-quality products. Eppendorf OEM also offers full product control and lifecycle management, which enables customers to reduce the risks associated with changing materials, and schedule production for planned demand. Eppendorf OEM is also committed to manufacturing high-quality products with a long lifespan which further reduces the cost of ownership. As a trusted brand with a history of vibrant,

long-standing partnerships, Eppendorf OEM delivers utmost reliability for sophisticated custom solutions.

To learn more visit  
<http://eppendorf.global/I3C>



TANJA MUSIOL, EPPENDORF AG

# Let's Talk About Tomorrow!

“TOMORROW LAB since 1945” was the motto of the 2020 celebrations of the 75th company anniversary of Eppendorf. Even though the actual party had to be cancelled due to the coronavirus pandemic, there was room to look back and reminisce – about old friends in the lab, good stories, and interesting milestones. There were also many occasions to talk about what we are all thrilled of: the laboratory of tomorrow and the future of the life sciences.



“Let’s just add the campaign title, and ... done.” Eileen Duve, Live Marketing Manager, compiles the final images before the virtual room which hosts the anniversary celebrations goes online. Together with Lukas Wonrath, Project Manager Global Marketing Communication, who is responsible for the company anniversary, she sits – at a distance, of course – at the desk at the Eppendorf headquarters in Hamburg and plans Exhibition 4.0. On the new virtual platform “Eppendorf Planet of Knowledge”, our customers can explore everything about the Eppendorf anniversary (also see article on page 13).

## Exhibition 4.0 instead of coffee and cake

“The original plan was to invite our customers for coffee and cake at the Analytica

in Munich, back in March 2020”, says Wonrath. The restrictions that came with Sars-Cov-2, however, forced the team to be creative and move all planned activities online. As a result, all Eppendorf social media channels and the website featured the 2020 anniversary. Whether it involved considering the five major questions of the future or reviewing the milestones of the company’s history – our customers were at the center of the conversation, and they were given many opportunities to become part of the campaign themselves.

## A dash of nostalgia

Many customers recounted their personal “Eppendorf moments”. They recalled their first set of pipettes at university or the iconic MiniSpin® centrifuge, as well as

experiments that demanded the utmost patience – and the support of Eppendorf products. “Your pipettes are the primary tools that have allowed me to study an unseen world, make significant discoveries, publish new information, secure project funding, and make a real difference”, reminisces one scientist.

## Looking ahead

“The anniversary year has highlighted once again the broad spectrum of the science that Eppendorf has the privilege of supporting daily across the globe”, Wonrath summarizes. With the five major questions of the campaign, the challenges of the future were addressed at the same time: what is the value of basic research for new projects; how will the food supply be secured and health questions be solved; and how automated and digitized will the laboratory of the future be?

Eppendorf is already offering approaches to solutions, and it will continue to be the expert and partner by our customers’ side in the 75 years ahead – providing the very tools that will allow scientists worldwide to conduct research for a better future.

Learn more about our campaign at [www.eppendorf.com/75-years](http://www.eppendorf.com/75-years)

JAN-HENDRIK BEBERMEIER, EPPENDORF AG

# Sustainability in the Lab: an On-Going Journey

Energy-guzzling ULT freezers, biohazardous waste, radioactive markers, large bags of used plastic tips and tubes, noisy instruments or devices with unergonomic handling, 24/7 science jobs, limited job contracts and budgets. There are a number of question marks when it comes to sustainability in the laboratory.



Sustainability covers the three columns of environmental, social, and economic aspects. Also, there is a special situation in the lab where staff security, sample safety, and expectations towards sustainable progress need to be reconciled. Depending on the product group, we take different approaches on our journey to increased sustainability.

For example, consumables: Tubes and tips are indispensable in the lab as they safeguard the purity and the safety of samples. However, the resulting enormous amounts of plastic waste – despite good ideas – still cannot be recycled in a proper way. Eppendorf has realized that the potential for reduction of raw materials used in production on the one hand, and reusing products on the other hand,

has not yet been exhausted. We therefore continue to invest large amounts of capital, as well as time, in the research of more environmentally friendly alternatives to the commonly used single-use oil-based plastics.

For example, instruments: Centrifuges run only several minutes or hours per day; their power consumption is lower than that of devices which run 24/7 (freezers, incubators, etc.). Nevertheless, by applying new, innovative technology, the power consumption of every new lab instrument can be optimized. Even small improvements benefit the environment. At the same time, we will never compromise sample safety. For example, when you set the temperature to 4°C for the purpose of spinning sensitive protein

samples, dependable temperature accuracy is a prerequisite as it relates directly to reproducibility and data reliability.

The list of challenges is long. In order to solve them, manufacturers and users will ideally listen to each other and cooperate. The work never ends – it is an on-going journey. On this journey, we not only explore new technologies with respect to green products, but we also research alternative materials and optimized processes. Each one of these changes has the potential to contribute to progress in the area of sustainability.

More information at  
<http://eppendorf.global/I48>

GRAEME ROBERTS, BIO-ITECH-EPPENDORF GROUP, GRONINGEN, NETHERLANDS

# Make Several Labs Work as One – Fast!

PhagoMed Biopharma GmbH, founded at the Campus Vienna BioCenter in November 2017, develops phages and phage-derived proteins as treatments of last resort for drug resistant bacterial infections. The company's goal, says Dr. Lorenzo Corsini, CEO of Research and Development, is to develop robust phage-based pharmaceuticals that are validated in rigorous clinical trials and immediately applied to the treatment of patients in need.

The current development programs, building on the research and clinical work of the founders, address prosthetic joint infections, urinary tract infections, and bacterial vaginosis. The team of eleven in Vienna, Austria, cooperates with labs at the Leibniz-Institut DSMZ and the Justus Liebig University in Germany and the Ghent University in Belgium.

**PHAGOMED**  
PHAGE-BASED THERAPIES

PhagoMed knew that the rapid growth of its distributed team, its ambitious research goals, and the need to move quickly into clinical trials demanded a way to share the research seamlessly with current employees and the rapidly onboarded new hires. A sophisticated digitally enabled laboratory would document every action and result precisely



and accurately; experimental work would be coordinated across all the various lab groups and locations; protocols and strategies would be standardized and shared; and samples would be tracked to allow reliable, immediate access and management, regardless of the freezer location.

In 2018, based on the recommendations of several other companies in the Campus Vienna BioCenter, PhagoMed selected eLABJournal® from Bio-ITech – an Eppendorf Company. Over 25,000 scientists throughout the world are using eLABJournal systems in their bioscience laboratories since they were first introduced in 2010. The functionality and capability of the systems is constantly evolving based on direct feedback from users.

With the scientific team based in several locations, PhagoMed needed instant, totally reliable access from anywhere on any device, so it chose the eLABJournal Cloud hosting solution. New team members had to be onboarded quickly and effectively – to access existing documentation, integrate their own experiments, and become fully productive almost overnight – so eLABJournal had to be simple to implement and quick to learn.

Lorenzo Corsini said it all: “eLABJournal is the cornerstone of our documentation processes. We use it to document experiments and protocols, manage biological samples, organize our –80 freezer, print

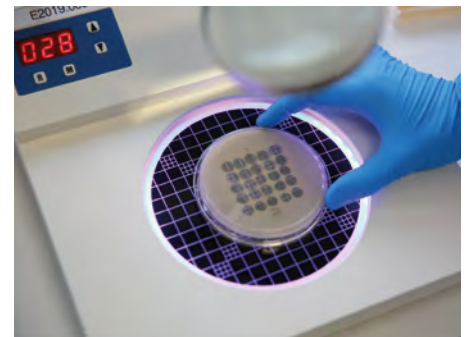

labels, and even order consumables – essentially using all of the features it offers. Clean documentation is the basis for reproducible research and progress in commercial R&D.”

More information:  
[www.phagomed.com](http://www.phagomed.com)  
<https://www.elabjournal.com/eppendorf>



EILEEN DUVE, EPPENDORF AG

# Eppendorf Planet of Knowledge

On the new internet platform “Eppendorf Planet of Knowledge”, you can now discover an entire galaxy of interesting and useful content, all about the Eppendorf world of products and their areas of application, while at the same time receiving comprehensive information. Register now free of charge and immerse yourself in the virtual Eppendorf world of experience.



Your starting point: the lobby of Eppendorf Planet of Knowledge

Since the emergence of COVID-19, it has become difficult for the Eppendorf experts and global sales teams to remain in contact with you, our customers. Live events such as exhibitions, symposia, and conferences were rescheduled or cancelled, and customer visits were no longer permitted for safety reasons – the situation called for a pragmatic yet attractive solution.

**We present: “Eppendorf Planet of Knowledge”!**

This virtual platform will host one-day events on various different topics and new products. You can participate in live webinars and discussion rounds, visit our virtual laboratory, and chat with one of our Eppendorf experts.

“Eppendorf Planet of Knowledge” is available online 24/7, and it is updated regularly in order to present you with the latest and most interesting content.

It is worth checking in from time to time to make the most of this comprehensive information, now at your fingertips.

Benefit from the virtual Eppendorf world of experience and stay in contact with us. Registration is free.

We look forward to meeting you on the “Eppendorf Planet of Knowledge”!

[www.eppendorf.com/virtualtradeshaw](http://www.eppendorf.com/virtualtradeshaw)



The virtual Eppendorf Lab

## CLOSE-UP

### Get Ready to Move It®!

Do you frequently transfer samples between different vessel formats, such as between tubes and plates, and strive for more efficient and safe solutions? The new adjustable tip spacing multi-channel pipette Move It accelerates and simplifies synchronous pipetting of a series of samples.

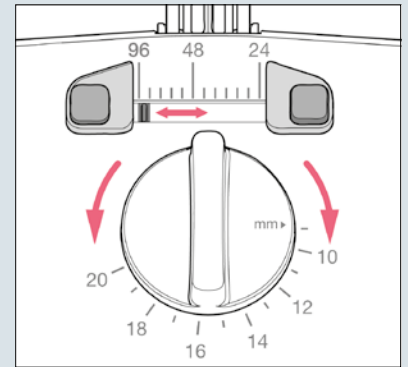

The close-up graphic shows the adjustment knob for manual tip spacing adjustment. Easy, fast, and vibration-free – for liquid transfer without dripping.

The live presentation of the Move It pipettes to a broad tradeshow audience could not take place as planned in 2020 due to the Covid 19 pandemic. Instead this event was relocated to the Eppendorf Planet of Knowledge (see article on the left side). There you can visit our virtual Analytica exhibition booth to get an impression of our new adjustable tip spacing pipettes.



**Tip:** To see Move It pipettes in action, watch our video „Get ready to Move It®“.

<http://eppendorf.global/kTX>

CAROLYN TAUBERT AND BERRIT HOFF, EPPENDORF AG

# Lauren Orefice & Randall Platt: Hamburg Visits Postponed

We would have loved to welcome our research prize winners 2019/2020 Lauren Orefice and Randall Platt to Hamburg in the summer of 2020. But the Corona situation forced us to change our plans because health and safety are top priority. So, we are looking forward to getting to know them personally or meeting them again at a later date.



**eppendorf  
& Science**  
PRIZE FOR  
NEURO  
BIOLOGY

[www.oreficelab.org](http://www.oreficelab.org)

Despite Corona, we have been in lively contact with Lauren Orefice (*Eppendorf & Science Prize for Neurobiology* 2019). The result was a fascinating portrait of her for our magazine *Off the Bench*\*. Under the title "The Power of Touch", Lauren reports among other things that approximately 85 percent of patients with ASD (autism spectrum disorders) react in an extremely sensitive way to even the lightest touch. With her research, Lauren Orefice wants to contribute to the improvement of treatments for autism disorders.

\*Issue 1/2020; available at [www.eppendorf.com/otb](http://www.eppendorf.com/otb)

Due to the Corona pandemic, the Young European Investigators Conference, planned for June 2020 at the EMBL ATC in Heidelberg, initially postponed by one year, was ultimately cancelled. We deeply regret this because, to mark the 25<sup>th</sup> anniversary of



<https://bsse.ethz.ch/platt>

the *Eppendorf Award for Young European Investigators*, a veritable number of award alumni had registered with a great lecture program. A special highlight was to be the award ceremony for the 2020 award winner, Randall Platt.

Instead there will be a live stream of the double award ceremony for both Randall and the 2021 winner on June 24, 2021.

[www.eppendorf.com/award](http://www.eppendorf.com/award)

Some measures have been coordinated virtually, for example the popular NATURE podcast. In the episode "Hijacking the CRISPR System to Create 'Living Diagnostics'", Randall talks about his award-winning work to create a "molecular recorder".

[go.nature.com/eppendorf2020](https://go.nature.com/eppendorf2020)

#### Trademark information

Amazon® is a registered trademark of Amazon Technologies, Inc., USA. ARC® and Hamilton® are registered trademarks of Hamilton Company, USA. Gibco® is a registered trademark of ThermoFisher Scientific, Inc., USA. Illumina® is a registered trademark of Illumina, Inc., USA. Mettler Toledo® and Mettler Toledo ISM® are registered trademarks of Mettler-Toledo AG, Switzerland. SeraseqT® and SeraCare® are registered trademarks of SeraCare Life Sciences, Inc., USA. AGT™, AmpliSeq™, and Dynamis™ are trademarks of ThermoFisher Scientific, Inc., USA. Horizon™ is a trademark of Horizon Discovery, UK. iSeq™, MiniSeq™, MiSeq™, and NextSeq™ are trademarks of Illumina, Inc., USA. Waters™ is a trademark of Waters Corporation, USA. Eppendorf®, the Eppendorf Brand Design, BioBLU®, CellXpert®, epMotion®, Eppendorf QuickLock®, Eppendorf Research®, Eppendorf Tubes®, epPoints®, FemtoJet®, Femtotips®, InjectMan®, Mastercycler®, MiniSpin®, Move It®, SciVario®, and VisioNize® are registered trademarks of Eppendorf AG, Germany. New Brunswick™ is a trademark of Eppendorf AG, Germany. eLABJournal® is a registered trademark of Bio-ITech B.V., Netherlands.

U.S. Design Patents are listed on <https://corporate.eppendorf.com/en/trademarks-patents>

# Win a Move It® Pipette

The solution of the prize competition of BioNews No. 52 was "THE NEXT LEVEL". The three main prizes, one Eppendorf Research® plus 16 or 24-channel pipette each, went to Subha N. (India), Diana N. (Spain), and Chiara N. (Italy).

## Good luck in our new competition!

Simply arrange all letters in the light gray boxes of the crossword in the correct order. Send us the solution until **June 30, 2021**.

Participate online at [www.eppendorf.com/bn-service](http://www.eppendorf.com/bn-service) or e-mail the solution to [bionews@eppendorf.de](mailto:bionews@eppendorf.de).

All correct answers will be considered for a prize for use in your lab. Winners will be notified in writing. Cash payment of the prize is not possible. No recourse to legal action. The judges' decision is final. Eppendorf employees and their families may not participate. The winner of the first prize will be published in BioNews No. 56.

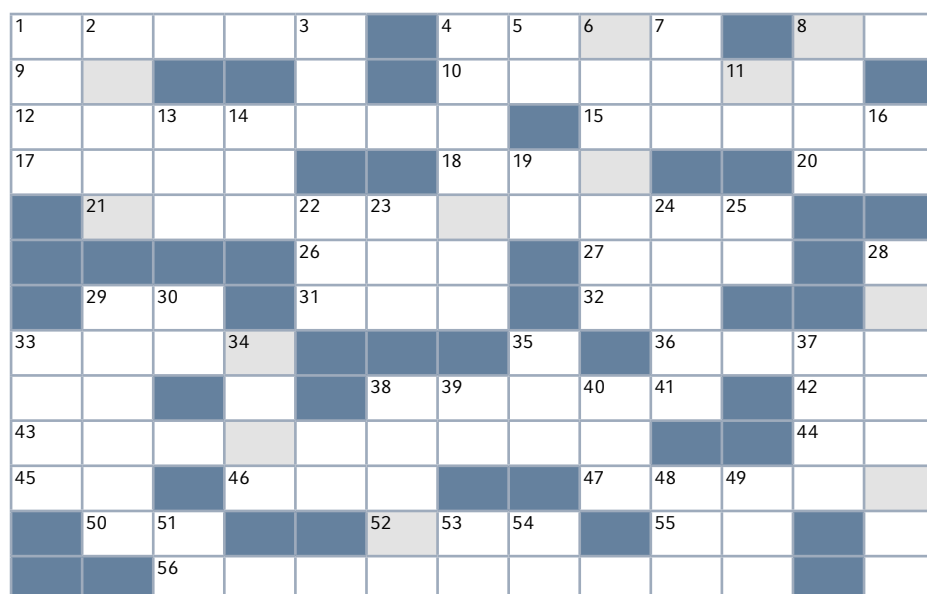

## ACROSS

- |  |  |
|--|--|
| 1 Infectious, replicates itself within bacteria            | 32 Second largest city in the USA (abbrev.)                          |
| 4 Part of the name of Eppendorf's new multichannel pipette | 33 Custard dessert, popular e.g. in Spain, Portugal                  |
| 8 Used in solar cells (chemical symbol)                    | 36 Tropical tree   |
| 9 Used in batteries (chemical symbol)                      | 38 Distinct period in a process of development                       |
| 10 Rise, beginning   | 42 Italian personal pronoun  |
| 12 Engaged in an activity on a non-professional basis      | 43 New planet in the Eppendorf universe                              |
| 15 Central part of a centrifuge                            | 44 Seoul is the capital (ISO country code)                           |
| 17 Female given name                                       | 45 Located on the Eastern coast of the Baltic Sea (ISO country code) |
| 18 Forms the negative (adverb)                             | 46 Down, blue, unhappy   |
| 20 Personal pronoun  | 47 Type of beer  |
| 21 There is no lab without one                             | 50 Chemical symbol for tantalum                                      |
| 26 Known for his James Bond novels (first name)            | 52 Program for mobile devices  |
| 27 Method, skill, facility                                 | 55 ISO country code for Romania                                      |
| 29 Programmable electronic device (abbrev.)                | 56 Cuts costs in the cell culture lab                                |
| 31 Exclamation of excitement, surprise (internet slang)    |  |

## DOWN

- |  |  |
|--|--|
| 1 Makes sense with "du jour" or "form"             | 30 Circa (abbrev.)   |
| 2 New in the Eppendorf Group                       | 33 Often combined with 34 down                                       |
| 3 French season                                    | 34 Information, report   |
| 4 Time from sunrise to noon                        | 35 To stay or fall behind  |
| 5 Gold in French                                   | 37 Positive reaction on social media                                 |
| 6 New type of events or platforms                  | 38 Foot operated lever   |
| 7 The self of an individual                        | 39 High density (abbrev.)  |
| 8 White, cold, melts at 0°C                        | 40 French salt   |
| 11 Computer and telecommunication branch (abbrev.) | 48 Administrative district in Paris (abbrev.)                        |
| 13 Swedish ski resort                              | 49 Set on Westeros and Essos (abbrev.)                               |
| 14 Transaction number in electronic banking        | 51 Complements DC  |
| 16 Chemical symbol for element 75                  | 53 Smallest element of a picture (abbrev.)                           |
| 19 Preposition                                     | 54 Eppendorf Tubes® are made of this thermoplastic polymer (abbrev.) |
| 22 Spanisch uncle                                  |  |
| 23 Computer memory (abbrev.)                       |  |
| 24 Used for making wine, juice, or jam             |  |
| 25 Loveable alien                                  |  |
| 28 ... lab since 1945                              |  |
| 29 Celestial body                                  |  |

## 1<sup>st</sup> Prize:

1 Eppendorf Research® plus Move It® pipette of your choice

## 2<sup>nd</sup> to 5<sup>th</sup> Prize:

1 Amazon® Voucher worth 50.00 EUR

## 6<sup>th</sup> to 10<sup>th</sup> Prize:

500 bonus epPoints® each

(epPoints registration required)

## Solution hint for prize competition of BioNews No. 54:



Send us the solution until **June 30, 2021**. Participate online at [www.eppendorf.com/bn-service](http://www.eppendorf.com/bn-service) or e-mail the solution to [bionews@eppendorf.de](mailto:bionews@eppendorf.de). Information about the use of your personal data can be found at [www.eppendorf.com/gdpr](http://www.eppendorf.com/gdpr)

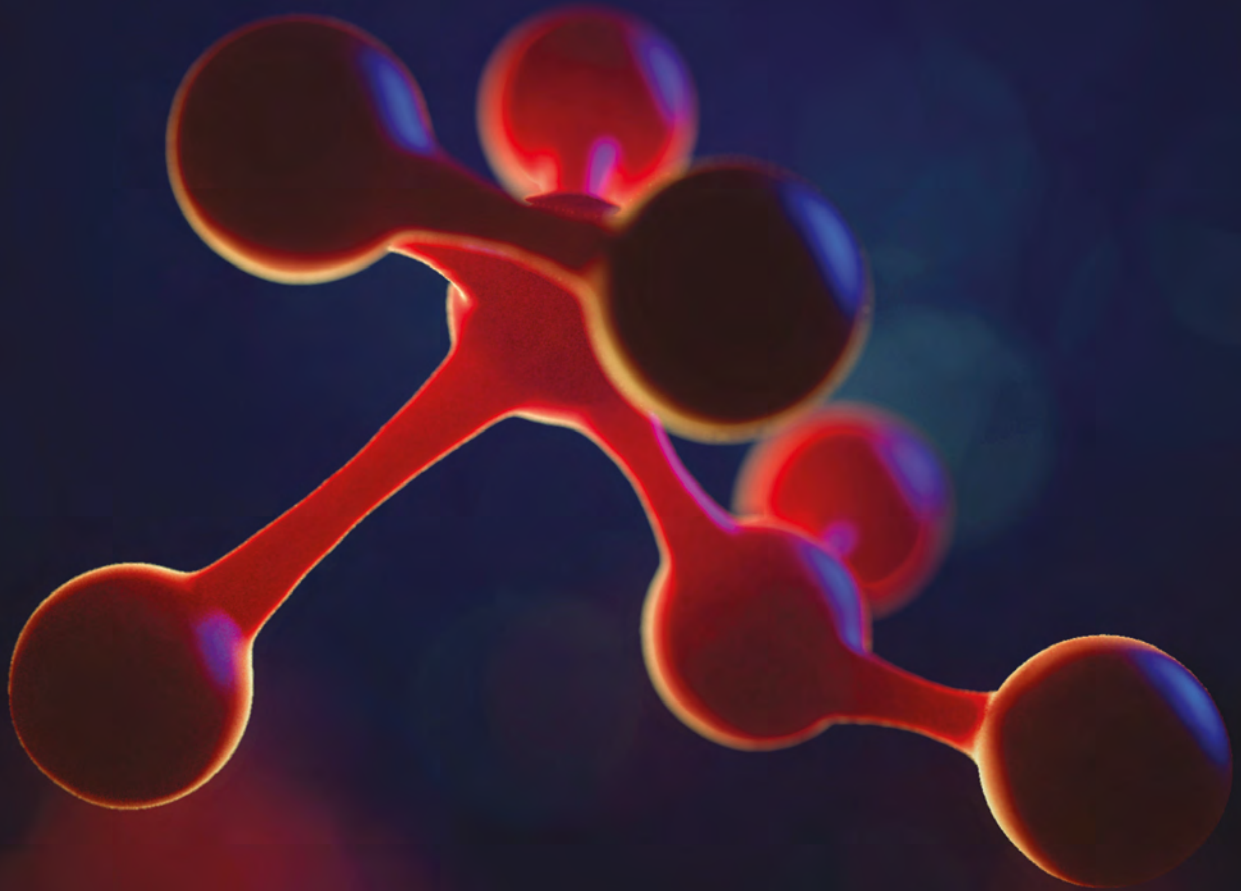

## Publish your research in the *Science* family of journals

The *Science* family of journals (*Science*, *Science Advances*, *Science Immunology*, *Science Robotics*, *Science Signaling*, and *Science Translational Medicine*) are among the most highly-regarded journals in the world for quality and selectivity. Our peer-reviewed journals are committed to publishing cutting-edge research, incisive scientific commentary, and insights on what's important to the scientific world at the highest standards.

**Submit your research today!**

Learn more at **[ScienceMag.org/journals](https://www.sciencemag.org/journals)**

**Science**  
JOURNALS 