

Catalogue 2024

Discover the World of **eppendorf**



Follow us on



E-Mail



Videoclip



Webshop



Download



Website



Files



Augmented Reality



Dear Reader,

Quality, reliability, experience and innovation – these are the terms that are associated with Eppendorf worldwide. This solid reputation is the result of more than 78 years of commitment to offering the unique solutions for handling valuable samples in life science research. At Eppendorf, it is not merely about the products. For us, it is about the person – it is about you, about our customers. We consider it our duty to offer you our high-quality products together with comprehensive support. To this end, we combine the Eppendorf quality of the products with extensive

services. Moreover, we are convinced that innovation is a fundamental prerequisite for scientists to be able to make the world a better place while at the same time facilitating their everyday work. So you can find also various new Products in this catalog.

Your success is our daily motivation.

Browse our catalog and be convinced by our portfolio.

We look forward to another successful year by your side!
Your Eppendorf catalog team

Welcome!

As a leading life science company, we at Eppendorf develop, produce and distribute multiple systems for use in laboratories worldwide. Our product range includes pipettes, centrifuges, mixers or freezers and much more. In addition, we provide a broad selection of high-quality consumables. Digital laboratory management solutions for complete laboratory processes round out our portfolio of customized services and product solutions for you.

Have fun browsing and discovering!

New Highlights 2024

Industries & Solutions

- Sustainability
- Biopharma
- Academia
- OEM
- Digital Lab Management

Manual Liquid Handling



Automated Pipetting

Temperature Control and Mixing



Tubes and Plates



Centrifuges and Rotors



PCR



Bioprocess

Freezers



CO₂ Incubators



Service Products

EU-IVD Products



Lab Shakers

Different mains
voltage versions

Your local contact

Legal notices, trademarks,
patent and design attributions

New Highlights 2024

See page 28 - Manual Liquid Handling chapter



epT.I.P.S.[®] BioBased Sterile Reloads

The reduction of plastics and the use of less fossil raw materials, is a common concern in all laboratories worldwide. In accordance with the “Reduce & Reuse” principle, the new sterile reload from Eppendorf for the new sterile epDualfilter T.I.P.S. BioBased and epT.I.P.S. BioBased requires significantly less fossil-based polypropylene than corresponding disposable racks. Thus, this represents a significant contribution to waste avoidance in laboratories.

LiquidPro[®] Positive Displacement Pipettes

Coming soon: LiquidPro - a highly ergonomic positive displacement pipetting system designed to address the pain of handling challenging liquids and to take your pipetting reproducibility to a new level. With 3 pipettes and 5 tip volumes, the LiquidPro system covers the volume range of 1 μ L to 1,000 μ L. Whether you need to pipette highly viscous, dense, hot, cold, corrosive, or hazardous liquids, the new LiquidPro pipetting system ensures the extraordinary precision and accuracy – no matter who uses it in the lab.



See page 46 - Manual Liquid Handling chapter

See page 10 - 11 - Automated Pipetting chapter

epMotion[®] 5073 and epMotion[®] 5075



The new generation of epMotion provides high-performance automated liquid handling and sample processing. With over 20 years of expertise in developing pipetting robots, Eppendorf brings you a liquid handler that is operated with a highly intuitive software and adapts to your unique sample journey. epMotion addresses your needs, giving you full flexibility and a huge variety of combination possibilities while pipetting with high precision and accuracy. In just a few clicks, you decide which consumables are used and whether shaking or heating is required. Adjust sample numbers, pipetting volumes, and incubation times intuitively, right before starting your protocol. The best part? No programming skills are required.

See page 10 - PCR chapter

Mastercycler® X40

Discover the easy way to raise your standard for endpoint PCR. The new Mastercycler X40 combines reliable quality and reproducible results with intuitive operation and an exclusive design. The 12-column gradient function, as well as flexibility for PCR consumables together with the adaptive SafeLid to prevent evaporation allow a relaxed way to optimize PCR protocols. The Mastercycler X40's light weight and small footprint makes it ideal for academic and cramped labs.



See page 88 - 93 - Centrifuges and Rotors chapter

High-Speed and Ultracentrifugation Consumables



Discover consumables for your High-Speed and Ultracentrifuges with our new overviews offering a simplified selection.

See page 12 - Freezers chapter



CryoCube F101h

The personal -80°C ULT freezer CryoCube F101h fits below your bench. The update results in a shorter pull-down time of just 120 min, a power consumption of only 4.7 KWh/ day (230 V; -80°C), and a silence level of just 40 dBA (230 V). The flexible shelf set-up can store up to 66 standard freezer boxes of 53 mm/ 2 in. The instrument is assembled with 100% renewable energy and is driven by hydrocarbons. Keep your samples close at hand.

SafeCode plates

The well-known SafeCode concept is now also available for different plate formats. The pre-labeled datamatrix code, enhanced by barcode on three sides and one human readable code, enables clear and safe identification of the vessel. The SafeCode function provides ID-specific documentation as Certificate of Quality, technical drawings, lot-number, product description, and order number. Benefit from reliable sample management with SafeCode consumables and combine them with the eLabNext sample management software. Discover PCR plates, DWP, and MTP with SafeCode.



See page 22 - Freezers chapter

Sustainability



Our commitment to people and the environment

To achieve sustainable success, we consider not only financial but also environmental and social aspects in our business activities and strive to harmonize these three dimensions. Sustainability has always been an integral part of our company:

Our products are becoming ever more sustainable and help ensure that research can be carried out optimally all over the world. We

are continuously working on protecting the environment and are aware of our significant responsibility as an employer towards our employees.

Our commitment to society manifests itself in many ways and is closely linked to our core competencies. Compliance with laws and regulations is more than a matter of course for us.

Sustainability Vision

A Systematic Approach to Sustainability

Our mission "to improve human living conditions" requires us to positively transform the Eppendorf Group to operate safely within the planetary boundaries and respecting humanity: We aim cut down the CO₂-emissions in our own operations down to zero until 2028, minimize the use of natural resources, and improve human well-being throughout our value chain. This vision is part of our strategic approach to take responsibility and contribute to a sustainable development.

Stakeholder-, Impact- and Success-oriented

For years now, Eppendorf has taken its corporate responsibility very seriously. In order to systematically integrate environmental and social aspects even more strongly into the Group's activities, Eppendorf has set itself a clear strategic framework. The basis of the strategic framework is a combination of integrating different perspectives on 20 responsibility topics relevant for Eppendorf: The dialog with various stakeholders, a data-based determination of our environmental and social footprint using an impact analysis and a success-oriented assessment.

Sustainability along the entire value chain

For Eppendorf, corporate responsibility does not begin with its own incoming goods, nor does it end at the sales table. Instead, the focus is on the entire value chain. Thus, the strategic framework includes many topics in the areas of climate change, natural resources, social compliance, human well-being, digitalization, and society - and this from the raw material supplier to the customer.

Our Management Team is committed to ensure successful implementation, each member of the Board of Management has assumed responsibility for a guiding theme.

Mid of 2023, we published our second sustainability report compliant to GRI standards.

Please find more details:

www.eppendorf.link/sustainability-report



Get all information about Sustainability at Eppendorf!

www.eppendorf.link/sustainability



Image source:
Westend61/Getty Images

Sustainability in the Lab Concerns Us All

Sustainability is becoming more and more important in public life. Wherever we interact in our personal area, there is a growing number of sustainability topics. The same holds true for our interaction with you, our customers in the labs worldwide. Whereas just a few years ago the topic of sustainability was mainly driven by dedicated employees in academic institutes and research-based companies, there has been a noticeable change for some time now. Purchasing departments as well as procurements systems request information. We see a growing interest in Eppendorf and our approach to sustainability.

Retrospect

In 2010, our centrifuge team started a green sustainability project. We found that a new centrifuge provided a far higher energy saving than expected. We were proud of the results. But the concept came too early: Energy efficiency in the laboratory was not yet the focus at that time.

Meanwhile, more and more customers expect sustainability facts about our products.

How Far can We Go? Safety First

The use of new, innovative technologies can optimize both resource consumption during production and power consumption during use. Even small improvements optimize the longevity of devices and thus contribute to greater sustainability.

Despite all needs for improved sustainability, there is a special situation in the lab: The safety

of the employees, combined with safety for the samples, is the focus, embraced by sustainable progress.

The safety of valuable samples is always our top priority. For example, the set temperature for centrifuging sensitive RNA samples must be maintained accurately throughout the process to ensure data reliability and reproducibility.



Beyond Green

The green idea may be the most familiar one, but in fact sustainability encompasses many environmental, social, and economic factors. At Eppendorf, we consider the entire supply chain and define our impact on sustainability in areas such as climate change and the use of natural resources, social compliance and human well-being, as well as with regard to data security and our role as responsible citizens in society.

This consideration begins before the product; it encompasses Eppendorf as an employer as well as a customer vis-à-vis our suppliers. Thus, our own Code of Conduct sets the bar. Our social behavior includes treating each other with respect, paying heed to the intellectual property of others, sticking to facts, and making ourselves reliable partners for our counterparts. These expectations are clearly defined and subject to continuous improvement and learning.



Remember 2008? Hydrocarbons - Green Cooling of the Future

As one of the very first advocates of green gases at -86 °C, Eppendorf now has more than 15 years of experience with hydrocarbons like R290/ R170 in R&D, production, logistics, and service in the field. In 2008, the Premium U570h ULT freezer was one of the very first commercially available ULT freezers driven by green cooling liquids. Replacement of the HFC based cooling liquids for refrigerated instruments is needed as global warming needs to be slowed down. The preferred hydrocarbons are also known as green or natural gases like R290 and R170. Due to this goal, we at Eppendorf clearly plan to replace all classic cooling in our portfolio within the next years. This is not limited to freezers but also includes the refrigerated centrifuges and refrigerated shakers. The new Centrifuge 5427 R with green cooling is our first step on this journey. Many more will follow. Discover more in the „Centrifuges and Rotors“ section.

Trust in Others: Independent Validation

As Eppendorf, we respect external test procedures and external independent test results of our products. Besides external test house checks for e.g. the ULT freezers, we ask for independent validation by third party organizations like ENERGY STAR®, My Green Lab®, or ISCC PLUS (International Sustainability & Carbon Certification).

Eppendorf collaborates with My Green Lab®, an international NGO that validates and certifies lab products with “ACT - The Environmental Impact Factor Label” since 2017.

We are proud of a growing number of ACT validated and certified Eppendorf products, e.g. different tips, tubes, ULT freezers, pipettes, centrifuges and more to come.

ISCC PLUS (International Sustainability & Carbon Certification) is a globally leading certification system, which offers solutions to address sustainability requirements for all feedstocks and markets. Thus traceability throughout the supply chain enables each player to source sustainable products from any certificate holder. The material of the biobased consumables is certified by ISCC.

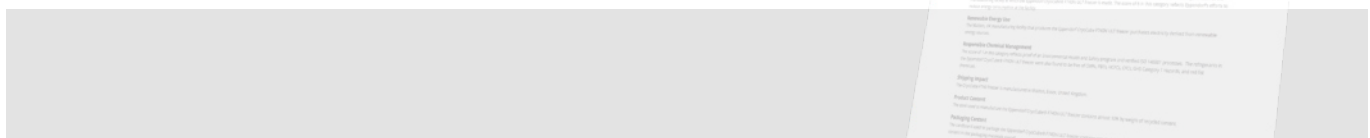

Sustainability



100% Renewable Energy for Assembly

Stepwise, our production facilities have been changed to power supply from renewable sources. Since 2021, we can proudly announce that nearly all products within the Eppendorf factories are assembled by 100% renewable power. But the product assembly is just one part of the energy story – the usage of lab instruments also requires energy. Did you already check the power origin in your lab?

Our Goal for 2028

We strive to cut our greenhouse gas emissions in our own operations down to zero until 2028. These reductions will include CO₂ emissions based on Scope 1, 2, 3.6, and 3.9. By changing the sources of external power supplies, we were able to already cut down our total emissions by 58% compared to 2019.

What Comes After the End?

Despite good ideas, lab waste still cannot be recycled efficiently, e.g., due to regulatory requirements for biological, chemical, or radioactive hazards.

Disposal of Packaging

The packaging of the products contains different materials. This includes mainly cardboard, plastic covers or bags, and some foam parts. Recycling of materials becomes more and more important. Our packaging cardboard material already consists of a high ratio of recycling material of 70 to almost 100%. Please support the global sustainability initiative of recycling valuable raw material by also collecting the packaging material and disposing of it in the appropriate collection containers at your organization. We suggest you to contact your local waste hauler or facility management team to understand the available recycling options for your organization.

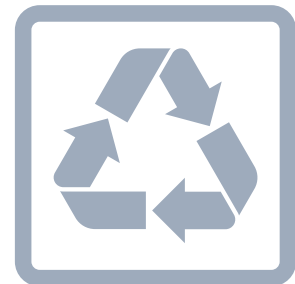



Disposal of Instruments

Our instruments last for many years, but if they need to be replaced, we kindly ask you to fulfill local requirements for disposal of these instruments. We strongly recommend a certified local recycling partner with experience in instruments from the lab. Keeping it “local” reduces the impact of transportation, and the „certified” aspect is recommended due to the safe and sustainable removal of all parts.



Image source:
Paket/shutterstock.com

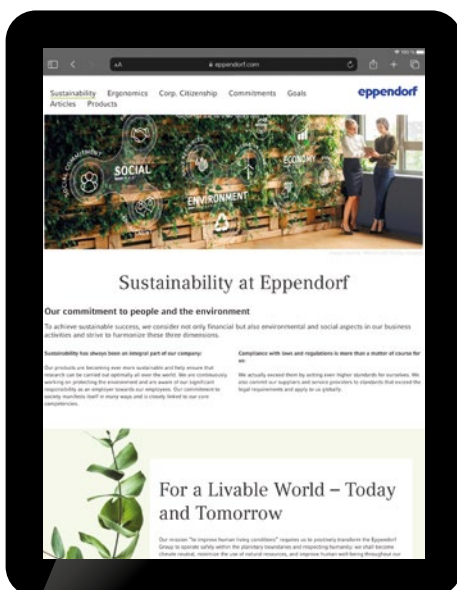

Sustainability: Our On-Going Journey

Science is based on facts. Statements such as “Our product is more sustainable compared to others” are questioned by researchers in many ways. Analyzing and improving sustainability issues requires knowledge and intensive work. None of the sustainability challenges can be solved quickly or easily. But they all require manufacturers and customers to listen to each other and work together.

This work is never over, but an on-going journey in which we communicate in constant dialogue with our stakeholders. We are researching new technologies, alternative materials and concepts. Each of these changes has the potential to contribute to progress in sustainability.



Get all information about Sustainability at Eppendorf!

www.eppendorf.link/sustainability

Biopharma

Vaccine Technology Platforms



Numerous vaccine technology platforms evolved over the past decades. Today, addressing disease outbreaks and protecting the immuno-compromised population provides severe challenges and harbors significant growth potential. Traditional whole-pathogen vaccine platforms score with a proven track record for many diseases. While these vaccines still require cultivation of the pathogen, the

newer generation such as recombinant protein and nucleic acid vaccines only require the genetic sequence of the pathogen. These breakthrough platforms can significantly accelerate development and manufacturing processes and unlock new potential for a broad range of indications at an unprecedented speed.

Traditional Vaccines

Inactivated vaccines

Inactivated vaccines (e.g., for hepatitis A, rabies, polio) still carry the full repertoire of immunogenic components of the original pathogen. Proper inactivation is mandatory to avoid viral reactivation and replication in the host.

+ Pathogen inactivation by radiation, heat, or chemical reagents ensures a superior safety profile and advantages in terms of transport and storage.

- Require processing of large quantities of the pathogen. The inactivation process can affect the antigen immunogenicity. As the antibody titers reduces over time, several booster doses are needed.

Live-attenuated vaccines

Repeated subculturing in a foreign host belongs to the most common methods to obtain attenuation of live-attenuated vaccines (e.g., for variola virus, measles virus, rotavirus). With each passage, the virus becomes less virulent. The native viral antigen conformation is still preserved, mimicking the natural infection without causing disease.

+ Usually produce long-lasting robust cellular and humoral immune responses with only one administration.

- Safety issues in immunosuppressed people may occur, weakened strains are difficult to obtain, development time is long, and refrigeration obligatory.



Strong Growing Vaccines

Protein subunit vaccines

Protein subunit vaccines (e.g., for influenza, hepatitis B and C) are a proven strategy for decades and still today in the spotlight for pandemic management.

+ Require no production of the whole pathogen because the vaccine consists of immunogenic viral or bacterial fragments generated by recombinant protein techniques. Since non-pathogenic, they are considered as safe. Multiple expression systems for antigenic protein components such as yeast, bacteria, insect, mammalian, and plant cells, allow the production of large quantities and to address unmet needs.

- Establishment of a proper scale-up of antigen production can be a major constraint. Several booster doses and adjuvants are needed.

Virus-like particle vaccines

Virus-like particle vaccines are self-assembled viral structural proteins that mimic the native virus. This feature enables to trigger strong immune responses.

+ Lacking the viral genome, the safety profile is excellent as the virus cannot replicate in the host. The production is scalable and safe as no living virus or inactivation steps are involved.

- The particle assembly is sometimes challenging, the manufacturing process complicated.



The Most Novel Vaccines

Nucleic acid vaccines

Nucleic acid vaccines are made up of mRNA or plasmid DNA encoding viral antigenic components to express specific proteins of a pathogen after injection. The technology of mRNA vaccines made its breakthrough with SARS-CoV-2. With dozens of potential applications including HIV, cancer, shingles, flu, cardiovascular applications, or Zika, It is a very promising technology.

+ Multiple advantages such as exceptionally fast modifiability in response to mutations, high versatility, high safety, and a fast, cost-efficient, and scalable production in a cell-free system. Vaccines for multiple indications can be produced using the same process.

- During vaccination the mRNA must be delivered directly into cells, which requires specific injection devices, electroporation, or a carrier molecule. mRNA vaccines exhibit instability and require a cold chain.



Improve Your Recombinant Protein Vaccine Discovery

Safe and consistent culturing of cells.

The **CellXpert® C170i** offers fast temperature and CO2 recovery (< 5 min/s) and very stable environmental conditions for (e.g.) virus host cells as well as reliable contamination prevention (e.g. 180 °C sterilization).



Speed up protein characterization assays.

The **Eppendorf Xplorer®** enables quick filling of plates using the dispensing mode. When connected to the **Pipette Manager**, an even quicker operation of the pipette is possible.

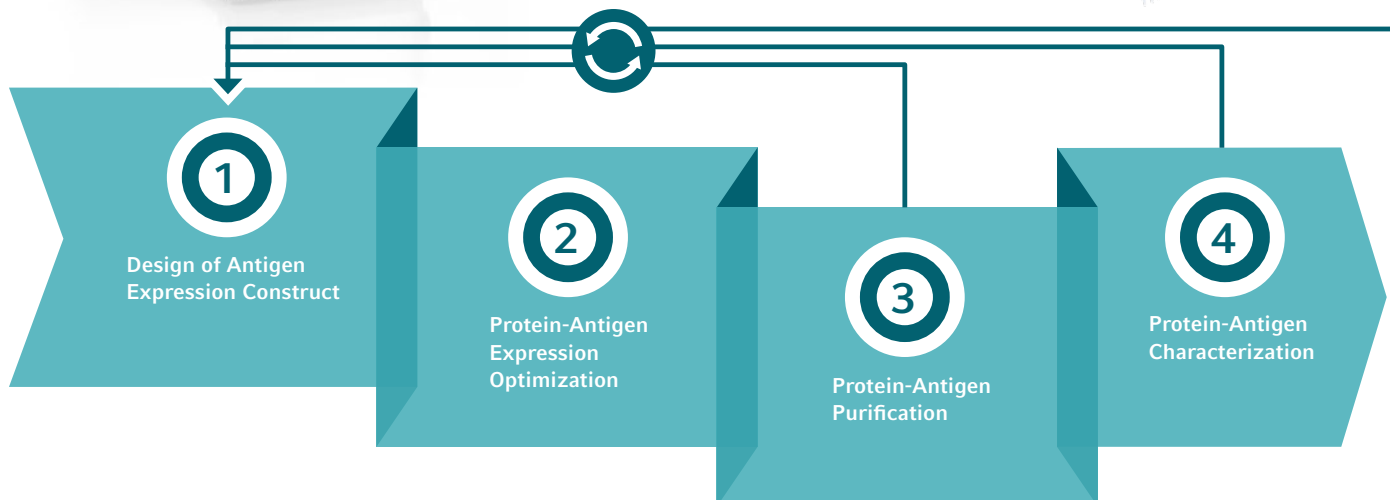

Protect your cells for protein-antigen production.

The **New Brunswick S41i Incubator Shaker** Design is ensuring minimum evaporation of media, stable conditions, and constant high humidity. Additionally, the high-temperature disinfection the seamless chamber design protect your cells during your initial R&D steps of overexpression optimization.



Maximize antigen retrieval.

The **LoBind®** material guarantees maximum sample retrieval for sensitive assays (e.g.) during protein-antigen characterization and lowest contamination risk. LoBind consumables are coating free and therefore, induce minimal risk of subsequent assay interference.

* For research use only. If you have any questions, please contact the Eppendorf Application Team.

Get all information about Pharma at Eppendorf!

www.eppendorf.link/pharma



Increase efficiency and downstream quality.

The **CR22N High Speed Centrifuge** with up to $58,700 \times g$ speed enables the pelleting of small insoluble particles to assure the quality of downstream applications. Triangular bottles can speed up harvesting after protein-antigen expression.



Automate your repetitive, routine tasks.

With the **epMotion®** you can use a variety of kits e.g. for plasmid isolation. The epMotion has an intuitive drag-and-drop-based software and full consumable flexibility.



Constant antigen expression conditions.

The **BioFlo® 320 Bioprocess Controller** offers an integrated Scale-up Assist software to facilitate uncomplicated and intuitive upscaling from R&D to production scale



Better mRNA Vaccine Development

Optimal transcription reaction conditions.

The Eppendorf **ThermoMixer® C** allows easy and precisely controlled up-scaling of the in vitro transcription reactions for mRNA production. The optional ThermoTop further increases temperature homogeneity and prevents condensate formation.



Find the right conditions with fewer PCRs.

The in vitro transcription for mRNA vaccines requires the amplification of long, sometimes GC-rich DNA templates. With the **Mastercycler® X50** 2D gradient function, up to hundreds of PCR conditions can be checked in one run, saving you time and money.



1

Template design
for In Vitro
Transcription

2

Template Production
in Bacteria/via PCR

3

mRNA
Purification

4

mRNA
Characterization



Smart and safe sample storage.

Safe Code Vials enable next level traceability when storing your mRNA at -80 °C. Get ID-specific consumable information for comprehensive documentation during your R&D phase. The ACT certified CryoCube freezers ensure energy efficiency and sample safety.

Maximize antigen retrieval.

The **LoBind®** material guarantees maximum retrieval of proteins and nucleic acids. This improves the reproducibility of sensitive assays, e.g. during antigen characterization. No coating further minimizes the risk of downstream assay interference.

* For research use only. If you have any questions, please contact the Eppendorf Application Team.

Get all information about Pharma at Eppendorf!

www.eppendorf.link/pharma



Safe and consistent culturing of cells.

The **CellXpert® C170i** offers fast temperature and CO₂ recovery (< 5 min/s) and very stable environmental conditions for (e.g) virus host cells as well as reliable contamination prevention (e.g. 180 °C sterilization).



Speed up In Vitro screening assays.

The **Eppendorf Xplorer®** enables quick filling of plates using the dispensing mode. When connected to the **Pipette Manager**, an even quicker operation of the pipette is possible.



Automate your repetitive, routine tasks.

With the **epMotion®** you can use a variety of kits e.g. for mRNA purification. The epMotion has an intuitive drag-and-drop-based software and full consumable flexibility.



Boost mRNA yield and quality.

The liquid-free control system of the **DASbox® Mini Bioreactor System** ensures fast and precise temperature control of mRNA synthesis reactions. The variable speed pumps of the DASbox ensure accurate addition of reaction components to increase the efficiency of mRNA synthesis.



Improve the Development of Viral Inactivated / Attenuated Vaccines

Safe and consistent culturing of cells.

The **CellXpert® C170i** offers fast temperature and CO2 recovery (< 5 min/s) and very stable environmental conditions for (e.g) virus host cells as well as reliable contamination prevention (e.g. 180 °C sterilization).



Thousands of PCRs in as little as 15 mins.

Large numbers of PCRs are required to amplify viral genomic information prior to sequencing. The **Mastercycler® X50** with the 384-well silver block can process hundreds of PCRs in as little as 40 min and with a fast polymerase kit even in less than 15 min. Connect up to 50 devices for increased throughput.

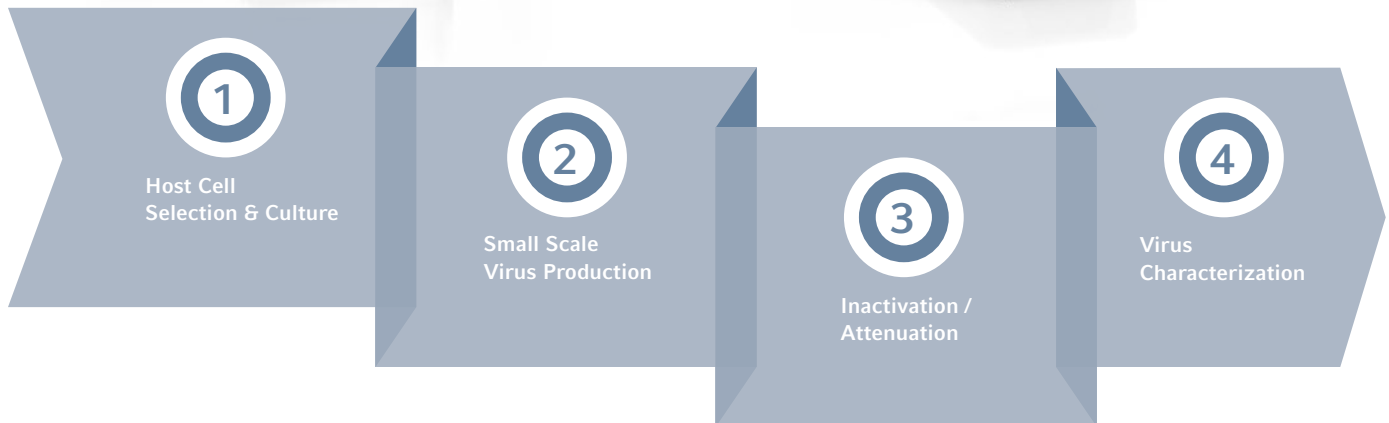

Ensure optimal assay performance.

The **LoBind®** material guarantees maximum sample retrieval for sensitive assays. It also demonstrates low virus binding activities. LoBind tubes are free of surface coating for lowest contamination risk.



Reproducible PBMC isolation.

The **Centrifuge 5910Ri** has soft acceleration/break ramps to support PBMC isolation during Ficoll gradient separation and reduced stress on sensitive immune cells used in immunology assays.

* For research use only. If you have any questions, please contact the Eppendorf Application Team.

Get all information about Pharma at Eppendorf!

www.eppendorf.link/pharma



Ensure optimal assay performance.

Eppendorf Plates® LoBind® ensure maximum sample recovery during quantitative assays. They can be customized with barcodes for efficient sample tracking and are available printed with their LOT number.



Speed up virus characterization assays.

The **Eppendorf Xplorer®** enables quick filling of plates using the dispensing mode. When connected to the **Pipette Manager**, an even quicker operation of the pipette is possible.

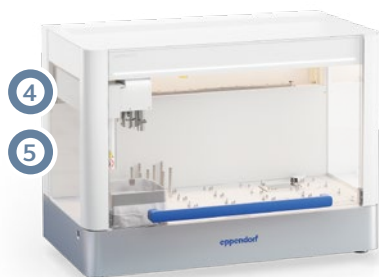
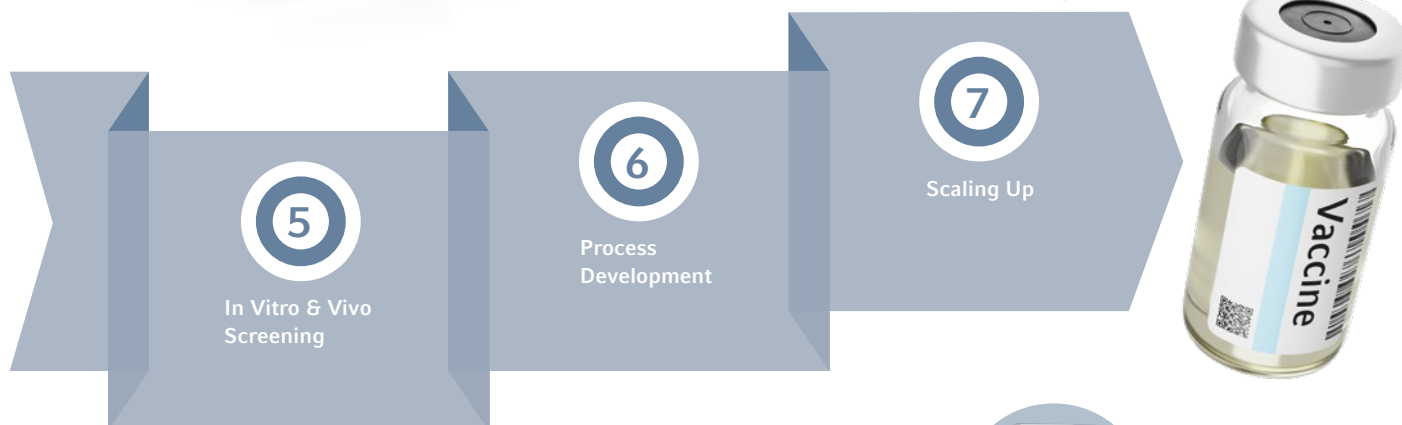

Automate your repetitive, routine tasks.

With the **epMotion®** you can use a variety of kits. The epMotion has an intuitive drag-and-drop-based software and full consumable flexibility.

Smart and safe sample storage.

Safe Code Vials enable next level traceability when storing your sample at -80 °C. Get ID-specific consumable information for comprehensive documentation during your R&D phase. The ACT certified CryoCube freezers ensure energy efficiency and sample safety.



Academia

Curtain up for the Academic Research: “Your Work Matters”



On our new website “Your Work Matters” we not only offer scientists from academic research the opportunity to present themselves and their projects. Our experts also give tips on topics such as increasing efficiency or saving time and impart technological background knowledge.

Anyone working in academic research suffers from a similar condition: college or lengthy training is followed by long hours,

weekend work and low pay, coupled with a great deal of frustration and often low appreciation of the work. Presenting one’s own work and the research results of the working group is subject to lengthy review processes in a constant fight for good journals. Applications to speak at conferences and to present your own poster are limited to the purely scientific results - but where is the person behind it and what drives him?

Making Laboratory Life More Efficient and Easier

Raising research funds to increase resources or enable conference participation requires writing many proposals. But where do you get the time? Our experts support you in using the existing equipment more efficiently, in optimizing experiments or in selecting the right device for the widest possible range of applications. Our videos, webinars and technical articles are designed

to make your laboratory life easier and show you the way to more time savings, more efficiency and less frustration due to failures in experiments. Poster downloads or tips and tricks will help you to always keep the important points in mind. And of course, we also give suitable product recommendations for each topic, which should make your everyday work in the laboratory easier.



Check out the whole project
www.eppendorf.link/yourworkmatters



Get some tips
www.eppendorf.link/support-matters

Your Project Matters

A platform on which one can present oneself and one's own research freely, openly and personally was missing until now. With "Your Project Matters" we are now giving academic science a face and a voice and showing academic research in all its diversity in the form of video and text interviews. We have already interviewed numerous scientists and would like to hear more exciting projects.

We would like to know from you what made you go into science and stay on the ball with your topic. How do you motivate yourself, your

employees and colleagues to keep going in the hope of improving the living conditions of people and animals, discovering new things and preparing the world for the future? What do you like about laboratory work and what can you live without? And above all: what is your project?

Check out the stories of the scientists. Or would you like to tell your story too? Then apply now!

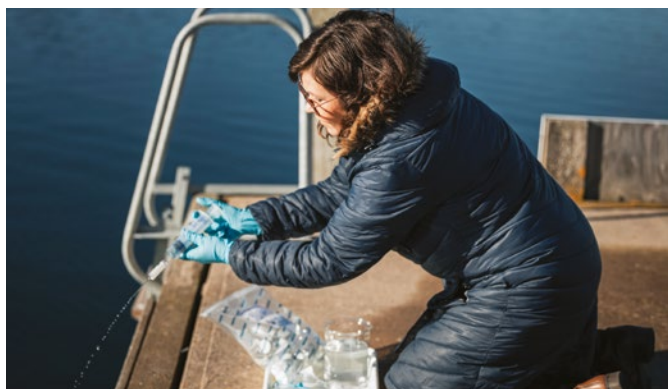

Marina Panova, Scientist, Gothenburg, Sweden:

"There is a great potential in environmental DNA to replace our traditional [invasive biodiversity] monitoring methods [of marine organisms]."



Sara Häkli, PhD student, Kuopio, Finland:

Saras' study aims to understand epileptic events during non-REM sleep phases and their correlation to memory loss in Alzheimer patients.

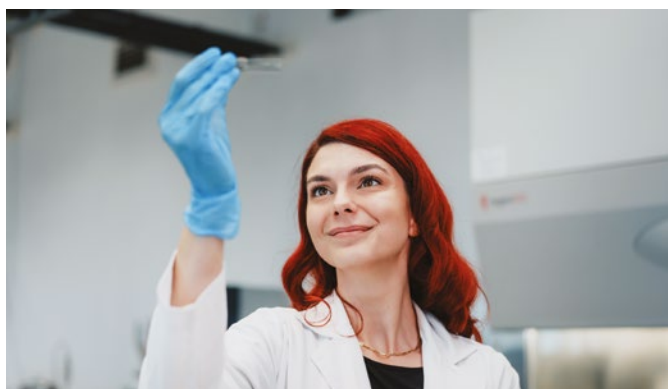

Carmen Nicolae, Medical engineer, Bucharest, Romania:

"I [...] contribute to developing innovative treatment options [and] try to help people that suffer from bone defects."



Rinalda Proko, PhD student, Fayetteville, Arkansas, USA:

"My goal is to identify some proteins that interact with [...] septins [causing] pathogenesis in fungi, such as Magnaporthe oryzae [...] which is responsible for causing rice blast disease."



Watch the interviews
www.eppendorf.link/yourproject

OEM

Trust Our Expertise



With Eppendorf OEM as your partner, you can take advantage of decades of competence and experience in developing and manufacturing high-tech laboratory products with premium quality.

Find an OEM product or component that perfectly fits to your requirements and applicational needs and start partnering with us today.

Searching for a manufacturer capable of producing your OEM solution in a high volume?

- > Production scalability at high volumes can be achieved through our proprietary precision molding technologies
- > Automated quality checks measure coaxiality and residual volume of tips as well as 100% in-line filter inspection
- > Manufacturing sites in Germany and the US secure delivery on-time, worldwide
- > Fully automated manufacturing facilities ensure a low level of contamination
- > In-house development and manufacturing of injection tools results in high quality production with extremely low failure rates

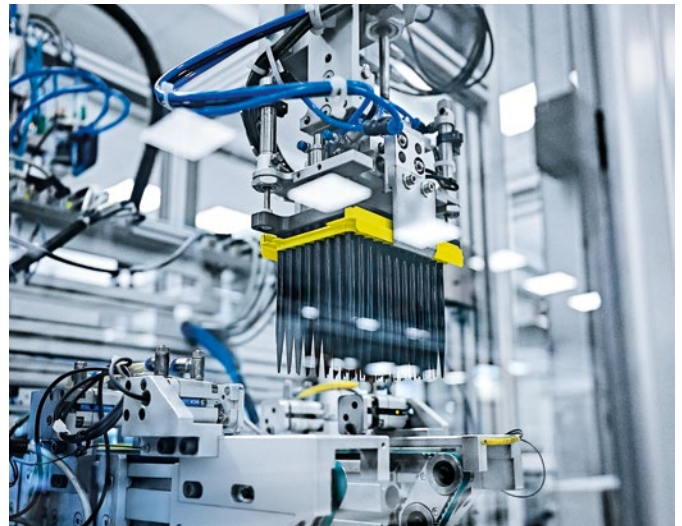

Planning your OEM project?



oem@eppendorf.com

Contact our OEM experts

Do you want to know more about how we can support you with OEM solutions?



Get all information about the Eppendorf OEM portfolio!

www.eppendorf.link/oem-portfolio

Your Benefits when Partnering with Eppendorf OEM



Fast time to market



High scalability



Variety of in-house capabilities

With you every step

We know it can be a struggle to integrate custom design diagnostic components. But it doesn't have to be that way. If you are looking for precision engineering, understanding and expertise – you've come to the right place.

With Eppendorf OEM, you'll benefit from our decades of experience in the manufacture of premium-quality components as well as our deep scientific domain understanding.



Quality down to the tips

Using only the purest raw materials and performing quality and functional checks throughout the entire production process, Eppendorf OEM products always come with premium quality.

Since our production is fully automated, contamination is reduced as far as possible.

ISO-certified for your confidence

Eppendorf is certified according to worldwide recognized and accepted ISO 9001, 13485 and 14001 standards.

This gives you the confidence that all processes in product design, manufacturing and marketing are defined and monitored in order to ensure consistent products and services.

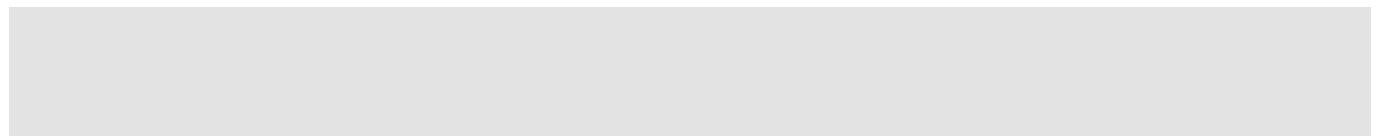
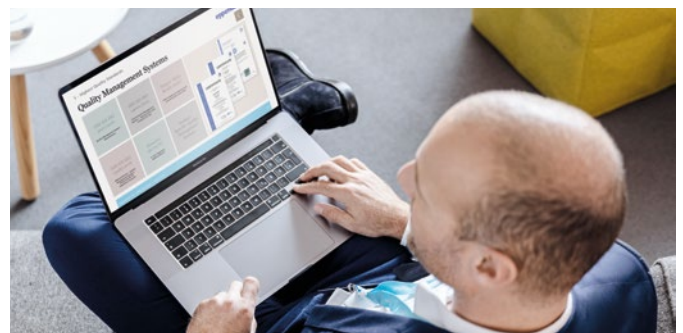

Your OEM Solution

Eppendorf is recognized as a global leader for its high quality standards, innovative technologies and cutting-edge developments. Take advantage of our competence and decades of experience in developing OEM partnerships and manufacturing high-tech laboratory products. All our products are manufactured to premium quality standards as we have our own production facilities.

Eppendorf OEM is covering the full lifecycle as an expert partner from concept and design to production, logistics and beyond. Our services include:

Requirements & specification

- > Analysis of requirements and specification definition
- > Central project management & complete documentation
- > Agile development

Product management

- > Product lifecycle management
- > On-market support – manufacturing, regulatory and change management
- > End of life product support

Infrastructure

- > Worldwide distribution centers
- > Manufacturing on multiple continents
- > Global regulatory & quality management systems

Design & prototyping

- > Material development
- > Polymer chemistry
- > Electronics design
- > Pilot runs for manufacturing
- > 3D printing & in-house tool making

Packaging

- > Packaging design
- > Transport studies
- > Sterile packaging

Performance test

- > Development of test systems
- > Documentation
- > Quality assurance

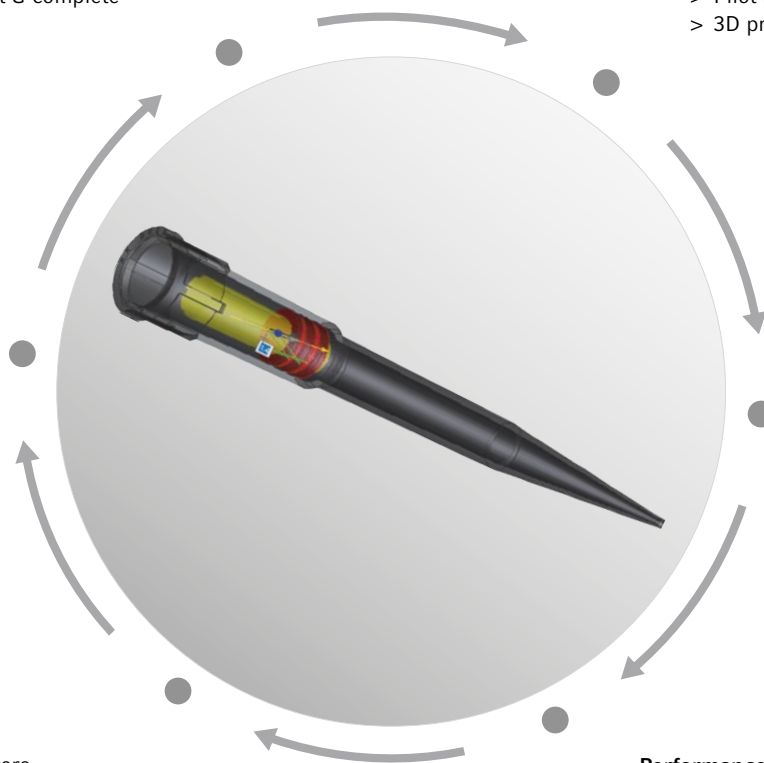

Customized Consumables



Eppendorf offers a broad range of consumables including a broad diversity of plates, tubes and tips. Whether you choose one of our standard products with a specific packaging or you prefer a customization, for example, a specific surface treatment, please contact us. We will support you with an optimized solution.

Customized tips for automation

Countless liquid handling workstations in the world work with Eppendorf conductive or non-conductive tips, benefitting from our high quality standards. Eppendorf tips for automation can cover a broad range of tasks in all major life science applications. Upon request, Eppendorf tips can also be equipped to comply with specific requirements.



Customized plates

Eppendorf offers a wide variety of plates: PCR, MTP and DWP. Plates can be customized, even to include specific barcoding using our automated barcode system. Plates can be provided in a number of customizable configurations: from labels, to 1D/2D barcodes to customer specific packaging.

Whether you choose one of our standard products with a specific packaging or you need a customization, please contact us.

Customized Instruments

Eppendorf offers you a choice from a variety of instrument configurations; covering your requirements for versatility, throughput, and speed (e.g. our epMotion® workstation). Request your customized solution today.



Watch our video about customized OEM consumables

www.eppendorf.link/oem-video

Digital Lab Management



Be prepared for tomorrow and ready for the future

Streamlined processes and operations are crucial for a successful laboratory. Once considered a vision, digitalization of the lab is becoming reality thanks to the advent of innovative digital lab solutions that aim to increase productivity when handling routine tasks in your lab.

And when it comes to digitalization, connectivity is key.

There are numerous ways to optimize and improve your laboratory processes through digitalization.

General lab tasks such as device monitoring, maintenance planning or experiment documentation are more efficiently solved by using software platforms.

Explore Eppendorf Digital Lab Solutions and make the switch to Digital Laboratory Management Solutions.

Lab Monitoring and Management with VisioNize® Lab Suite

One platform designed to empower you to focus on your next scientific breakthrough. VisioNize Lab Suite (VNLS) enables overall digital lab management including remote device monitoring, notifications, maintenance planning and device documentation options to improve sample safety, boost your lab's efficiency, enhance reproducibility as well as conformity with increasing compliance pressures. This gives you time to focus on what is important, your research!



Explore the gains of a digital, connected lab in our White Paper
www.eppendorf.link/whitepaper-lab-digitalization

Why switch to Visionize® Lab Suite

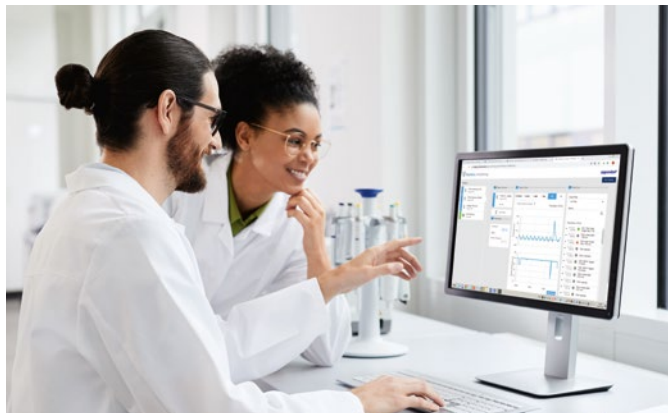

Real-time device monitoring to ensure proper functioning devices and sample safety.

- > Monitor your lab devices including incubators, freezers, and centrifuges from anywhere, at any time
- > Track critical parameters in real-time, such as temperature, O₂ and CO₂ levels
- > View performance history of your devices
- > Securely store historical data and visualize it in chart and event list formats

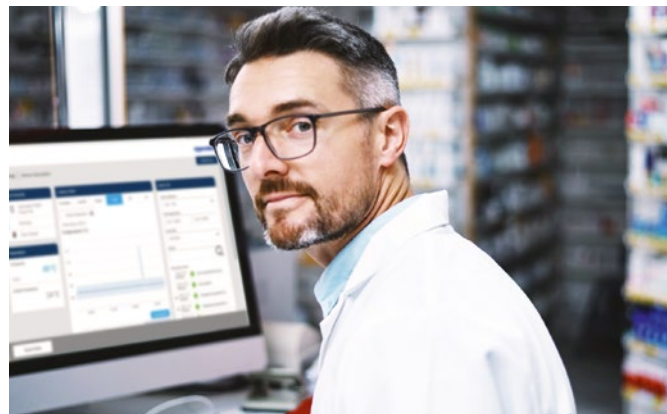

Streamline your internal audits and eliminate your paper-based documentation.

- > Quickly create reports for devices including:
 - > Time, date and user details
 - > Maintenance history
 - > Events, alerts, notifications acknowledgement
 - > Device trend data
- > Benefit from detailed audit logs with device performance data, such as parameters, user interventions, and setpoint changes

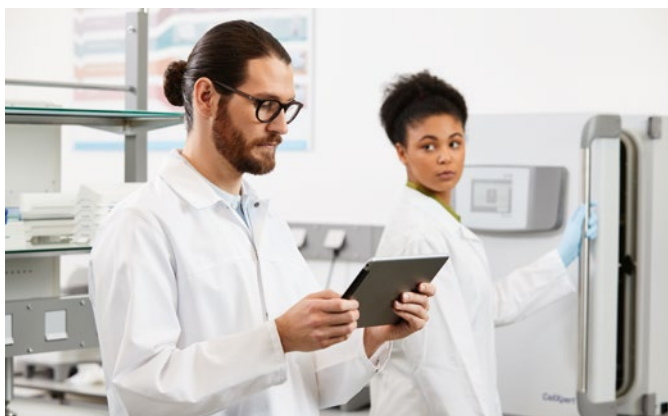

Evolve your maintenance routine and realize optimal device performance.

- > Setting of recurring tasks for devices or groups of devices
- > User defined reminders for upcoming task
- > Logging of task executions



Know that your samples are secure and be on the safe side with precise decision making.

- > User-defined notifications for alerts, events and more
- > Real-time device data on your computer, tablet or smartphone
- > User-defined alerts escalation scheme and acknowledgement for absent team member or assets with high value samples



Digital Lab Management

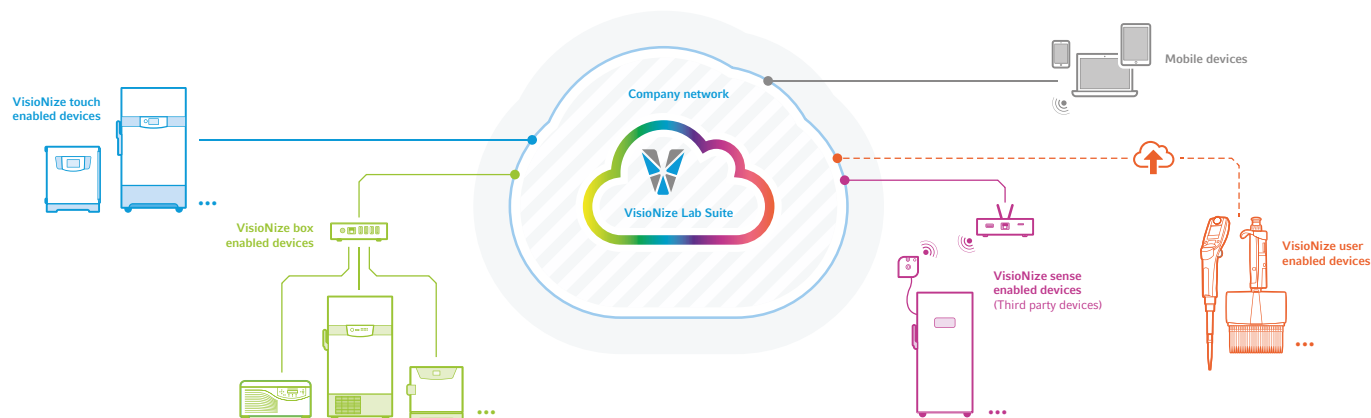

VisioNize® Lab Suite provides a universal laboratory digitization solution for monitoring instruments from pipettes to freezers regardless of their manufacturer and minimizes unintended instrument downtime.



Enable connectivity for remote device monitoring

VisioNize® sense is an all-in-one sensor system that works with VisioNize® Lab Suite to monitor the real-time status of devices and therefore protect integrity of samples. The system can capture, record and transfer even the smallest changes of your environmental conditions and can be used to monitor your lab rooms, CO₂ incubators, fridges or freezers from any supplier.

It includes an environmental monitoring sensor that measures ambient temperature, humidity, pressure and light, and a PT-100 extension that can measure temperature of any device (including ULT freezers) within the range of +60 to -90 °C.

Ordering information

Description	Order no.
VisioNize® Lab Suite Essentials plan , Free basic subscription for the first 3 connected devices. Includes monitoring, email notifications, remote updates, 7 days of live chart data and other essential features.	1112000309
VisioNize® Lab Suite Sample Safety+ plan , Includes all the functions of VisioNize Lab Suite Essentials plus SMS notifications, alert escalations, audit trail and extended data access.	1112000310
VisioNize® sense gateway router , routes the collected parameter data to VisioNize® Lab Suite	ESS1000001
VisioNize® sense environmental monitoring sensors , a wireless, rechargeable multi-sensor unit (ambient temperature, humidity, pressure & light)	ESS1000002
VisioNize® sense external temperature sensor , PT-100 extension that can measure temperature of any device (including ULT Freezers) within the range of +60 to -90 °C.	ESS1000003
VisioNize® sense monitoring kit , all-in-one package including temperature sensor, environmental monitoring sensors and gateway router.	ESS1000004



Learn more about VisioNize sense
www.eppendorf.com/visionize-sense



All-in-one electronic lab notebook and sample management with eLabNext®

Struggling with a paper-based documentation system? Or constantly lost in samples? Explore the eLabNext® solutions for your laboratory.

More than just an ELN

eLabJournal® offers an intuitive and flexible solution to document experimental information in your lab. This all-in-one electronic lab notebook also includes modules for sample tracking and experiment documentation.

The software is suitable for any lab ranging from small academic laboratories and start-up companies to large academic institutes and globally operating companies.

- > Fully customizable to fit your workflow
- > Collaborative access to any data
- > Secure and compliant

Flexible sample management for laboratories

eLabInventory offers an intuitive and flexible solution for inventory management in laboratories. This highly customizable software organizes any sample type in the lab and can be fully configured to work in your unique environment. It is available standalone or integrated into eLabJournal.

- > Visualize your inventory storage
- > Organize and optimize your lab
- > Maintain a full audit trail for every sample

eLabJournal

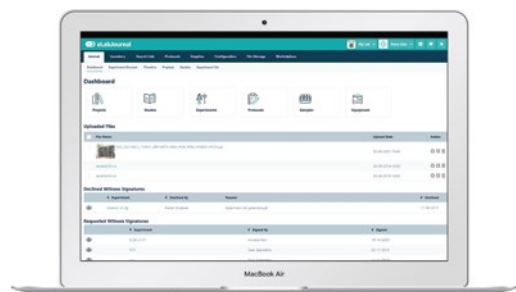

eLabInventory

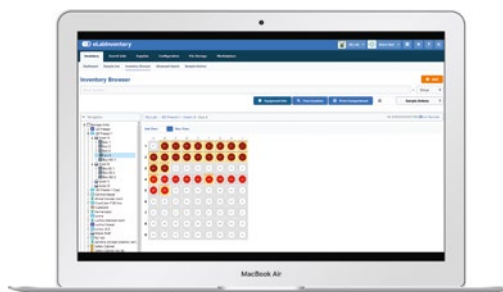

Learn more about
eLabJournal key features

www.elabnext.com/products/elabjournal



Learn more about
how to organize your lab

www.elabnext.com/products/elabinventory

Manual Liquid Handling

Eppendorf – Your Expert Partner for Liquid Handling



As the first company to launch a microliter pipette, we at Eppendorf have over 60 years' experience in precise manual and automatic pipetting & dispensing to transfer the smallest quantities of liquids. Today, liquid handling systems from Eppendorf are used wherever accuracy, precision, and absolute reliability are important.

To make your lab work more efficient, ergonomic and less cumbersome, we offer a wide portfolio ranging from award-winning mechanical single- and multi-channel pipettes over (connected) electronic pipettes and dispensers to fully automated pipetting robots. Rest assured that you'll find the right liquid handling solution with Eppendorf.

How to Select the Right Liquid Handling System

Selecting the right pipette or dispenser can be the key to success in your work. It can boost your efficiency and throughput and ensure reliable results for different use cases. Here is a quick introduction to the basics:

Air-Cushion Principle

Air-cushion pipettes are most commonly used in labs around the world and ideal for liquids with physical properties similar to water. In this instrument type, the piston is separated from the liquid sample by a small air cushion. Temperature or humidity changes, as well as the physical properties of different liquids can affect the performance of air-cushion instruments. To reduce these risks however, Eppendorf air-cushion pipettes work with extra small air cushions and may be adjusted temporarily to different liquid types.

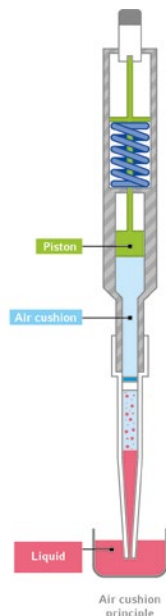

Positive Displacement Principle

In positive displacement systems, the piston is part of the tip and in direct contact with the liquid. There is no air cushion that may be affected by liquid sample properties. These tools are therefore ideal for liquids with varying viscosity, volatility, surface tension or density as well as hot or cold liquids. The disposable tips with integrated pistons also prevent contamination and help to keep user and instrument safe when working with hazardous liquids.

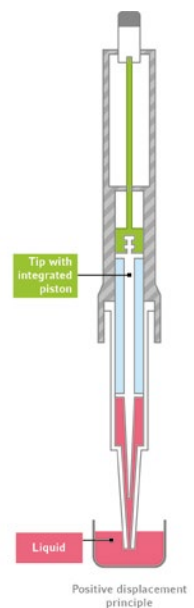

Not sure which pipetting system to choose?

Check out our new finder app:

www.eppendorf.link/LH-Selection





When Should You Use an Electronic Instrument?

The most important general benefits of using an electronic instrument are: better ergonomics by requiring almost no operating forces, higher precision and reproducibility as well as an additional efficiency gain due to various operating modes (such as e.g. pipetting and dispensing with only one tool). Furthermore, electronic pipettes are the basis for digital lab solutions supporting scientists with choosing settings for different liquid types, documenting pipetting steps and collaborating across the lab.

When Should You Think About an Automated Solution?

Automated liquid handling systems such as the epMotion® family are ideal to take over routine and repetitive pipetting tasks that are commonly found in many molecular biological applications. They are ideally suited whenever complex processes need to be standardized, help to reduce the risk of manual pipetting errors, increase reproducibility and free up your valuable time for other tasks.

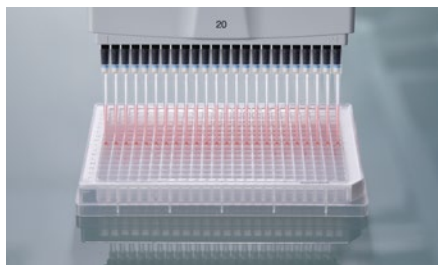

Eppendorf Pipettes and Pipette Tips: An Unbeatable Combination

The mere fact that a tip fits onto a pipette cone is no guarantee for the performance of a liquid handling system, which comprises of the components instrument and tip. Eppendorf micropipettes and epT.I.P.S.® pipette tips are designed to work in perfect unison and to ensure a maximum of precision and accuracy. With our wide portfolio of variants and sizes as well as certified purity grades, our pipette tips offering is tailored to various requirements in today's labs.

[Learn more at page 28](#)



Ensure Consistent Results with our Maintenance, Calibration & Adjustment Services

Pipettes and dispensers are precision instruments with moving parts subject to normal wear and tear that may lead to imprecision over time. Therefore, regular maintenance and calibration are fundamental to the precision and accuracy of your instruments. We provide sincere, reliable services to help you maintain premium performance, and maximum safety of our instruments and your applications.

[Learn more at page 8 in the "Service Products" chapter](#)

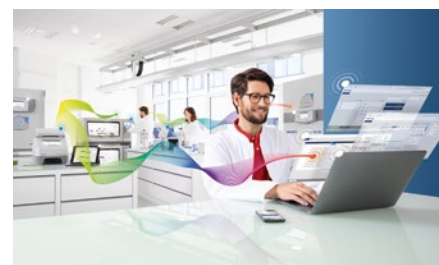

Your Transition to the Lab of the Future – with Eppendorf

Digital solutions can make everyday lab work even safer and more efficient for you. Keep track of your instruments & samples and plan your next pipette calibration with our digital lab solutions or evolve your electronic pipettes with the Pipette Manager to work faster, more accurate and in collaboration with your fellow researchers while documenting your pipetting activities.

[Learn more at page 22 in the "Industries & Solutions" chapter](#)

Do you already know everything there is about pipetting?
Download our comprehensive guidebook and improve your pipetting skills even more!

www.eppendorf.link/download-pipetting-guide



Our Portfolio – Your Choice



Model	Eppendorf Research® plus	Eppendorf Reference® 2	Eppendorf Xplorer®/ Eppendorf Xplorer® plus
Page(s)	16	19	22
Product type	Pipette	Pipette	Pipette
Operating mode	mechanical	mechanical	electronic
Compatible with Pipette Manager	no	no	yes
Adjustable cone spacing	no	no	no
Pipetting type	Air-cushion system	Air-cushion system	Air-cushion system
Positioning	The light mechanical pipette with low operating forces for effortless pipetting	Fast and ergonomic single-button pipette with high precision and accuracy	Efficient, fast and precise pipetting with untiring battery power
Application	Pipetting of aqueous liquids, two-button operation	Pipetting of aqueous liquids, single-button operation	Pipetting of aqueous liquids
Volume range	0.1 µL – 10 mL	0.1 µL – 10 mL	0.5 µL – 10 mL
Available options	1-channel 8-channel 12-channel 16-channel 24-channel	1-channel 8-channel 12-channel	1-channel 8-channel 12-channel 16-channel 24-channel
Autoclavable	yes	yes	yes (lower part)
Consumables	epT.I.P.S.®, epT.I.P.S.® 384	epT.I.P.S.®	epT.I.P.S.®, epT.I.P.S.® 384
Purity grades of consumables	> Eppendorf Quality > PCR clean and sterile > Biopur® > Forensic DNA Grade	> Eppendorf Quality > PCR clean and sterile > Biopur® > Forensic DNA Grade	> Eppendorf Quality > PCR clean and sterile > Biopur® > Forensic DNA Grade
Open system (third party consumables)	yes	yes	yes

Get all the details of our pipetting portfolio!
Explore the eshop and get an overview!

www.eppendorf.link/pipettes



**Eppendorf Research® plus Move It®/
Eppendorf Xplorer® plus Move It®**

12
Pipette
mechanical/electronic
yes (Xplorer plus variants only)
yes
Air-cushion system
Double your pipetting performance: fast and secure multiple sample transfer between different formats made easy
Pipetting of aqueous liquids
1 – 1,200 µL
4-channel
6-channel
8-channel
12-channel
yes/yes (lower part)
epT.I.P.S.®, epT.I.P.S.® 384
> Eppendorf Quality
> PCR clean and sterile
> Biopur®
> Forensic DNA Grade
yes

Multipette® M4

48
Dispenser
mechanical
no
no
Positive displacement system
Speed up long dispensing series with low outside fault effects
Contamination-free dispensing (up to 100 steps per tip filling) of aqueous solutions and challenging liquids (e.g. viscous, volatile, dense...)
1 µL – 10 mL
1-channel
no
Combitips® advanced, ViscoTip®
> Eppendorf Quality
> PCR clean
> Biopur®
> Forensic DNA Grade
no

Multipette® E3/Multipette® E3x

49
Dispenser
electronic
no
no
Positive displacement system
Save time and accelerate long dispensing series, with high volume flexibility and lowest outside fault effects
Contamination-free motor-driven dispensing (up to 100 steps per tip filling) of aqueous solutions and challenging liquids (e.g. viscous, volatile, dense...)
1 µL – 50 mL
1-channel
no
Combitips® advanced, ViscoTip®
> Eppendorf Quality
> PCR clean
> Biopur®
> Forensic DNA Grade
no

Our Portfolio – Your Choice



Model	epT.I.P.S.®	epT.I.P.S.® Long	ep Dualfilter T.I.P.S.®	ep Dualfilter T.I.P.S.® SealMax®
Page(s)	32	35	34	34
Applications	<ul style="list-style-type: none"> > Pipetting liquids > Dispensing liquids > Mixing liquids > Filling plates and reaction vessels > Also available as epT.I.P.S.® BioBased > For applications with 384-well microplates, we recommend using 16- or 24-channel pipettes and epT.I.P.S.® 384 		<ul style="list-style-type: none"> > DNA applications (e.g. PCR) > RNA applications (e.g. gene expression analysis) > Protein applications (e.g. antibody research) > Cell culture applications (e.g. media) > Applications with radioactive material > Also available as ep Dualfilter T.I.P.S.® BioBased > For applications with 384-well microplates, we recommend using 16- or 24-channel pipettes and ep Dualfilter T.I.P.S.® 384 	

¹¹ An aerosol is a colloid of fine solid particles or liquid droplets, in air or another gas.



Model	Combitips® advanced	ViscoTip®
Page(s)	50	50
Applications	<ul style="list-style-type: none"> > Positive displacement principle (comparable to a syringe) > High-precision dispensing regardless of the physical properties of the liquid (like e.g. viscosity, volatility, density or temperature) > Prevents aerosol contamination with hermetically sealed piston for secure dispensing > Provides protection from radioactive and toxic substances > Quick dispensing of long series with precise, repeated dispensing of identical volumes (with Multipette® hand dispensers) 	<ul style="list-style-type: none"> > Positive displacement principle (comparable to a syringe) > For highly viscous liquids such as glycerol 99.5 %, Tween®, oils, creams, shampoos or honey > Quick dispensing of long series with precise, repeated dispensing of identical volumes (with Multipette hand dispensers)

Get all the details of our pipette tips portfolio!
Explore the eshop and get an overview!

www.eppendorf.link/tips





epT.I.P.S.® 384

33

- > Biochemical assays
 - > Cell based assays
 - > Immunoassays
 - > Storage of biological samples or chemical compounds
 - > Nucleic acid based methods
 - > Amplification
 - > Loading of agarose gels
 - > Purification
 - > Quantification
 - > Sequencing
-



ep Dualfilter T.I.P.S.® 384

33

- > DNA applications (e.g. PCR)
 - > RNA applications (e.g. gene expression analysis)
 - > Protein applications (e.g. antibody research)
 - > Cell culture applications (e.g. media)
 - > Applications with radioactives
 - > All applications which use aerosol¹³ binding liquids
-



Eppendorf Varitips®

52

- > Pipetting aqueous solutions
 - > Extraction of liquids from deep receptacles
 - > Transfer of organic liquids (alcohols, org. acids etc.)
 - > Transfer of solvents with high vapor pressure (e.g. diethyl ether)
 - > Transfer of liquids with high density
 - > Transfer of viscous liquids
-



Eppendorf Serological Pipets

57

- > Transfer of liquids
 - > Mixing suspensions
 - > Combining reagents and chemical solutions
 - > Transferring cells for empirical analysis or expansion
 - > Layering reagents for creating higher density gradients
-

Our Portfolio – Your Choice



Model	Varispenser® 2/Varispenser® 2x	Eppendorf Top Buret
Page(s)	54	53
Product type	Bottle-top dispenser	Bottle-top burette
Operating mode	mechanical	mechanical
Pipetting type	Positive displacement system	Positive displacement system
Positioning	Varispenser 2 / 2x bottle-top dispensers combine trusted technology with improved benefits for safe and easy dispensing of liquids without compromise.	Continuous and pulse-free manual titration
Application	Single stroke dispensing of lyes, acids, bases, aqueous liquids or solvents	Titration of aqueous liquids
Volume range	0.2 – 100 mL	0.1 – 999.9 mL
Available options		1-channel
Autoclavable	yes	no
Consumables	–	–
Purity grades of consumables	–	–
Open system (third party consumables)	–	–

Get all the details of our pipetting portfolio!
Explore the eshop and get an overview!

www.eppendorf.link/pipettes





Easypet® 3
56
Pipette controller
electronic
Air-cushion system
Overall ergonomic concept with speed control for stress-free pipetting

Pipetting of aqueous liquids with serological and volumetric pipettes

0.1 – 100 mL
1-channel
yes (pipette adapter and aspirating cone)
Eppendorf Serological Pipets
Sterile, pyrogen-, DNase-, RNase-, human and bacterial DNA-free. Non-cytotoxic.
yes

Pipet Helper®
57
Pipette controller
mechanical
Air-cushion system
The robust and intuitive design makes it a perfect entry-level instrument

Pipetting of aqueous liquids with serological and volumetric pipettes

0.1 – 100 mL
1-channel
yes
Eppendorf Serological Pipets
Sterile, pyrogen-, DNase-, RNase-, human and bacterial DNA-free. Non-cytotoxic.
yes



Experience the quality and convenience you have trusted in for decades with Eppendorf serological pipettes!

Designed to work in perfect harmony with your Easypet 3 or Pipet Helper, Eppendorf completes its portfolio in liquid handling with this serological pipette. For ease and flexibility, our serological pipettes can also be used with any other standard pipette controller.

Rely on precise graduations overlaid on ultra-clear pipette material for quick and easy volume readings from 0.1 mL to 50 mL. Enjoy the freedom of individually wrapped pipettes packaged in a robust dispenser box to ensure consistent premium quality.

See page 57.



Pipette Manager: Connect Your Pipettes



Evolve your electronic pipette with the Pipette Manager

Put connected electronic pipettes to use for faster operation, increased reproducibility and digital documentation of every step. The Eppendorf Pipette Manager is a standalone touch server that reacts in real-time with Eppendorf Xplorer®, Eppendorf Xplorer plus and Xplorer plus Move It® connected pipettes via WiFi technology.

How connectivity supports your pipetting activities

- > Transmit settings and other parameters quickly to connected electronic pipettes and start pipetting right away
- > Receive pipetting technique guidance and optimal settings for viscous, volatile and other challenging liquids
- > Choose from predefined Eppendorf liquid types (e.g. Acetone, Ethanol or Enzymes/Antibodies) or create your own
- > Digitally document your pipetting activities to increase repeatability and support comprehensive documentation
- > Manage your pipette fleet more effectively and enhance collaboration with your labmates (e.g. through sharing created liquid types)

The Pipette Manager will continue to evolve to include numerous updates and new features. Find the latest software updates at www.eppendorf.link/software-downloads



Learn more
about the Pipette
Manager:



[www.eppendorf.link/
pipette-manager](http://www.eppendorf.link/pipette-manager)



Upgrade Eppendorf Xplorer® / Xplorer plus and Xplorer plus Move It® pipettes with the Eppendorf Xplorer connect WiFi module and convert them into smart devices.

Pipette Manager: The external touch server establishes communication with connected electronic pipettes and tablets via WiFi technology.

Connect your tablets (Android® & iOS®) to work in parallel with other lab users.



The embedded software is based on the VisioNize touch interface concept that has been extensively tested by customers to reduce learning and adjustment time. It is used across different Eppendorf instruments, like the CryoCube® F740hi ULT freezer or the Mastercycler® X50.



The ordering information for this product can be found on the page 25

You want to give it a try?



www.eppendorf.link/pipette-manager-demo

Discover our digital Pipette Manager simulator, learn the first steps and see how it will redefine your lab work!





Move It®! Transfer Multiple Samples Across Vessels

Move It doubles your pipetting performance

Do you frequently transfer samples across different vessel formats, such as between tubes and plates, and strive for more efficient and safe solutions? The adjustable tip spacing pipette Move It® accelerates and simplifies synchronous pipetting of a series of samples. A unique design without tubing connections results in increased precision and durability as well as autoclavability, increasing user and sample safety.

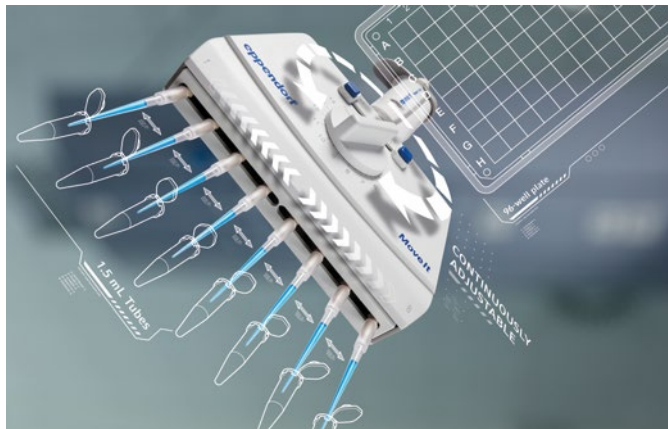

Product features

- > 4-, 6-, 8- and 12-channel air-cushion pipettes with variable volume and adjustable tip spacing option
- > Available as mechanical (Research plus) and electronic (Xplorer plus) adjustable tip spacing multi-channel pipette
- > For plates (384-, 96-, 48-, 24- and 12-well), tubes, agarose gels and more

Applications

- > ELISA
- > Cell culture
- > Cell-based assays
- > (Real time) PCR
- > Mouse genotyping
- > Blood analysis
- > FACS analysis
- > Media transfer
- > Dilution series
- > Screening

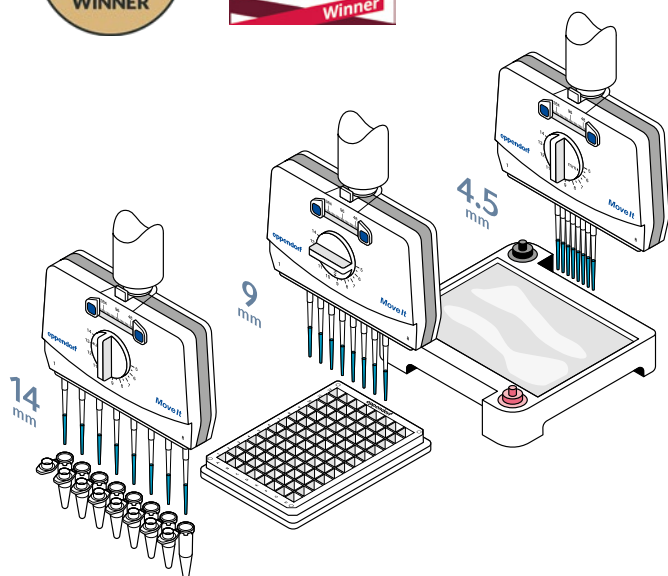

Multiple sample transfer between different formats becomes fast and secure with Move It

Instead of pipetting many times, move 4 – 12 samples simultaneously. Reduces throughput time significantly.

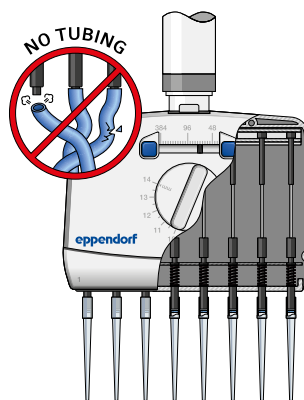

Move It pipettes work without any tubing connections. Your benefits: fewer moving parts and a smaller air cushion increase durability and precision. Furthermore, the unique design makes autoclaving possible.¹⁾

¹⁾ Research plus variants fully, Xplorer plus lower part only.

Learn more about
Move It®:



www.eppendorf.link/move-it

Move It® - Adjustable Tip Spacing Pipettes

Eppendorf Research® plus and Eppendorf Xplorer® plus

Move It selection guide

Look for source and destination formats according to your application and see which variant fits best.

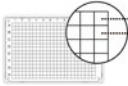
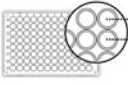
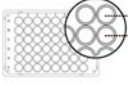
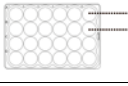
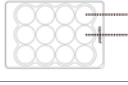
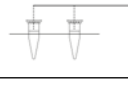
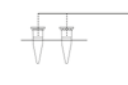
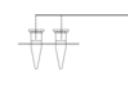
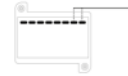

Vessel Type	Type of tips		epT.I.P.S.®			epT.I.P.S.® 384	
	electronic/mechanical		Xplorer plus/Research plus			Xplorer plus/Research plus	
	Number of channels		4	6	8	8	12
	Volume		300 µL/1,200 µL	300 µL/1,200 µL	300 µL/1,200 µL	20 µL/100 µL	20 µL/100 µL
	Tip distance (mm)		9-33 mm	9-20 mm	9-14 mm	4.5-14 mm	4.5-9 mm
 4.5	384 Wells					■	■
 9	96 Wells		■	■	■	■	■
 13	48 Wells		■	■	■	■	
 19	24 Wells		■	■			
 26	12 Wells		■				
 21-33	1.5/2.0/5.0/15 mL Tube		■				
 15-20	1.5/2.0/5.0/15 mL Tube		■	■			
 9-14	0.5/1.5/2.0 mL Tube		■	■	■	■	
 ~4.5-9	Agarose gel		■ ¹⁾	■ ¹⁾	■ ¹⁾	■	■

¹⁾ Limited suitability due to volume and size of tips.

Move It® - Your Options

You have the choice

Mechanical Research plus pipettes are the workhorses for each lab. Xplorer plus electronic pipettes are the ideal choice if you need several pipetting modes (e.g. dispensing or pipetting & mixing) and an additional boost in ergonomics with motor-driven pistons.



Move It®, mechanical multi-channel pipettes, adjustable cone distance

Ordering information		Order no.
Description		
Eppendorf Research® plus Move It® , 4-channel, 9 mm cone distance, variable, incl. epT.I.P.S.® Box 2.0		
30 – 300 µL, orange	■	3125000150
Eppendorf Research® plus Move It® , 4-channel, 9 mm cone distance, variable		
120 – 1,200 µL, dark green	■	3125000184
Eppendorf Research® plus Move It® , 6-channel, 9 mm cone distance, variable, incl. epT.I.P.S.® Box 2.0		
30 – 300 µL, orange	■	3125000168
Eppendorf Research® plus Move It® , 6-channel, 9 mm cone distance, variable		
120 – 1,200 µL, dark green	■	3125000192
Eppendorf Research® plus Move It® , 8-channel, 4.5 mm cone distance, variable, incl. epT.I.P.S.® Box 2.0		
1 – 20 µL, light pink	■	3125000117
5 – 100 µL, light yellow	■	3125000133
Eppendorf Research® plus Move It® , 8-channel, 9 mm cone distance, variable, incl. epT.I.P.S.® Box 2.0		
30 – 300 µL, orange	■	3125000176
Eppendorf Research® plus Move It® , 8-channel, 9 mm cone distance, variable		
120 – 1,200 µL, dark green	■	3125000206
Eppendorf Research® plus Move It® , 12-channel, 4.5 mm cone distance, variable, incl. epT.I.P.S.® Box 2.0		
1 – 20 µL, light pink	■	3125000125
5 – 100 µL, light yellow	■	3125000141

Move It®, electronic multi-channel pipettes, adjustable cone distance

Ordering information		Order no.
Description		
Eppendorf Xplorer® plus Move It® , 4-channel, 9 mm cone distance, variable		
15 – 300 µL, orange	■	4861000816
50 – 1,200 µL, green	■	4861000833
Eppendorf Xplorer® plus Move It® , 6-channel, 9 mm cone distance, variable		
15 – 300 µL, orange	■	4861000817
50 – 1,200 µL, green	■	4861000834
Eppendorf Xplorer® plus Move It® , 8-channel, 4.5 mm cone distance, variable		
1 – 20 µL, light pink	■	4861000781
5 – 100 µL, light yellow	■	4861000794
Eppendorf Xplorer® plus Move It® , 8-channel, 9 mm cone distance, variable		
15 – 300 µL, orange	■	4861000818
50 – 1,200 µL, green	■	4861000835
Eppendorf Xplorer® plus Move It® , 12-channel, 4.5 mm cone distance, variable		
1 – 20 µL, light pink	■	4861000782
5 – 100 µL, light yellow	■	4861000795



384. Ready. Set. Pipette 16 or 24 Wells in Just One Step!

Are you tired of pipetting into 384-well plates? Do you yearn for a convenient, ergonomic, and safe solution? Look no further than Eppendorf's innovative 16- and 24-channel pipetting system, designed to streamline your workflows and enhance your productivity.



Fill 384 wells within a minute

- > No more tedious work and mistakes due to inconvenient alternate well pipetting with 8- and 12-channel pipettes
- > Set up or validate an automated process manually and have a reliable backup system in place
- > Increase your throughput today and change from 96- to 384-well plates

Eppendorf 16- and 24-channel pipettes are available as mechanical Research® plus or Eppendorf Xplorer® plus electronic pipettes for increased ergonomics and added versatility.



Superior ergonomics and precision with epT.I.P.S.® 384

epT.I.P.S. 384 and ep Dualfilter T.I.P.S.® 384 micropipette tips with innovative SOFTattach technology are optimized for our 16- and 24-channel pipettes, as well as 20 µL and 100 µL Move It® adjustable tip spacing pipettes.



Your benefits

- > Elastic forming grooves provide a perfect seal while operating forces are reduced to a minimum
- > Outstanding and reliable tip fit and tightness
- > Reduced tip attachment and ejection forces

See page 42 for epT.I.P.S. 384 article numbers.

Learn more about
our multi-channel
pipettes:



[www.eppendorf.link/
multi-channel](http://www.eppendorf.link/multi-channel)

Learn more about
our 384-well plate
pipetting system:



[www.eppendorf.link/
ready-set-pipette](http://www.eppendorf.link/ready-set-pipette)





Eppendorf Research[®] plus

The light pipette for effortless pipetting

The Eppendorf Research plus mechanical pipette is the result of over 60 years of experience in liquid handling and is one of the most commonly used pipettes in the world. Thanks to the pioneering Eppendorf PhysioCare Concept[®], the Research plus is highly ergonomic and protects your health in the laboratory. It features low weight and operation forces, is extremely reliable, fully autoclavable and easy to use.

With a variety of options available, including single-channel pipettes with fixed or variable volume, multi-channel pipette options with 8-, 12-, 16- or 24-channels, and our Research plus Move It[®] adjustable tip spacing micropipettes (see page 32), we are confident that we can offer the right choice for your application.



Product features

- > Mechanical air-cushion pipette for accurate, easy & ergonomic pipetting of aqueous solutions
- > Feel the difference in weight and pipetting forces: this ultra-light pipette is designed according to the Eppendorf PhysioCare Concept[®] principles
- > Enjoy minimal tip attachment forces due to a spring-loaded tip cone (available for all pipettes up to 1 mL) that reduces stress without sacrificing tip tightness

Applications

- > Forward pipetting
- > Reverse pipetting
- > Removal of supernatants
- > Sample mixing
- > Phase extraction
- > Filling of plates, gels, and reaction vessels



A joy for your eyes - 4-digit volume display on Eppendorf Research[®] plus mechanical pipettes.

Ordering information

Description	Order no.
Eppendorf Research[®] plus, 1-channel, fixed	
10 µL, medium gray	3124000016
10 µL, yellow	3124000024
20 µL, light gray	3124000032
20 µL, yellow	3124000040
25 µL, yellow	3124000059
50 µL, yellow	3124000067
100 µL, yellow	3124000075
200 µL, yellow	3124000083
200 µL, blue	3124000091
250 µL, blue	3124000105
500 µL, blue	3124000113
1,000 µL, blue	3124000121

Learn more about the Research plus:



www.eppendorf.link/researchplus



Ordering information		
Description		Order no.
Eppendorf Research® plus , 1-channel, variable, incl. epT.I.P.S.® Box 2.0		
0.1 – 2.5 µL, dark gray		3123000012
0.5 – 10 µL, medium gray		3123000020
2 – 20 µL, light gray		3123000098
2 – 20 µL, yellow		3123000039
10 – 100 µL, yellow		3123000047
20 – 200 µL, yellow		3123000055
30 – 300 µL, orange		3123000101
100 – 1,000 µL, blue		3123000063
Eppendorf Research® plus , 1-channel, variable, incl. epT.I.P.S.® sample bag		
0.25 – 2.5 mL, red		3123000144
0.5 – 5 mL, violet		3123000071
1 – 10 mL, turquoise		3123000080

Ordering information		
Description		Order no.
Eppendorf Research® plus , 8-channel, variable, incl. epT.I.P.S.® Box 2.0		
0.5 – 10 µL, medium gray		3125000010
10 – 100 µL, yellow		3125000036
30 – 300 µL, orange		3125000052
Eppendorf Research® plus , 8-channel, variable		
120 – 1,200 µL, dark green		3125000214

Ordering information		
Description		Order no.
Eppendorf Research® plus , 12-channel, variable, incl. epT.I.P.S.® Box 2.0		
0.5 – 10 µL, medium gray		3125000028
10 – 100 µL, yellow		3125000044
30 – 300 µL, orange		3125000060
Eppendorf Research® plus , 12-channel, variable		
120 – 1,200 µL, dark green		3125000222

Ordering information		
Description		Order no.
Eppendorf Research® plus		
16-channel, variable, incl. epT.I.P.S.® Box 2.0, 1 – 20 µL, light pink		3125000079
16-channel, variable, incl. epT.I.P.S.® Box 2.0, 5 – 100 µL, light yellow		3125000095

Ordering information		
Description		Order no.
Eppendorf Research® plus		
24-channel, variable, incl. epT.I.P.S.® Box 2.0, 1 – 20 µL, light pink		3125000087
24-channel, variable, incl. epT.I.P.S.® Box 2.0, 5 – 100 µL, light yellow		3125000109





Eppendorf Research® plus Multi-packs



Ordering information

Description

Eppendorf Research® plus, 3-pack, 1-channel, variable, incl. 3x epT.I.P.S.® Box 2.0 and ballpoint pen

Option 1: 0.5 – 10 µL, 10 – 100 µL, 100 – 1,000 µL

Option 2: 2 – 20 µL yellow, 20 – 200 µL, 100 – 1,000 µL

Eppendorf Research® plus, 3-pack, 1-channel, variable, incl. 1x epT.I.P.S.® Box 2.0, 2x epT.I.P.S. sample bags and ballpoint pen

Option 3: 100 – 1,000 µL, 0.5 – 5 mL, 1 – 10 mL

Eppendorf Research® plus, 6-pack, 1-channel, variable, incl. Pipette Carousel 2, 6x epT.I.P.S.® Box 2.0 and ballpoint pen

0.1 – 2.5 µL, 0.5 – 10 µL, 2 – 20 µL (yellow), 10 – 100 µL, 20 – 200 µL, 100 – 1,000 µL

Order no.

[3123000900](#)

[3123000918](#)

[3123000926](#)

[3123000942](#)

Accessories

Accessories

Description

Reagent reservoir Tip-Tub, autoclavable reservoir for the aspiration of liquids with multi-channel pipettes, 1 set = 10 reservoirs and 10 lids

Grease for pipettes, incl. lint-free applicators, to relubricate the piston or cylinder in pipette lower parts

Protection filter, 2.5 mL, for Eppendorf Research® plus, Reference® 2 and Xplorer® (plus), 10 filters with 1 filter sleeve, for 2.5 mL pipettes, color code: red

Protection filter, 5 mL, for Eppendorf Research® plus, Reference® 2 and Xplorer® (plus), 10 filters with 1 filter sleeve, for 5 mL pipettes, color code: violet

Protection filter, 10 mL, for Eppendorf Research® plus, Reference® 2 and Xplorer® (plus), 10 filters with 1 filter sleeve, for 10 mL pipettes, color code: turquoise

Safety plug tools, for Eppendorf Research® plus, to change the factory adjustment, 5 pcs.

Adjustment tool, for Eppendorf Research® plus and Reference® 2, to change factory or temporary adjustment

Adjustment seal ADJ, for Eppendorf Research® plus, red, 5 pcs.

Pipette wrench 2 mL – 10 mL, to open single-channel pipette lower parts from 2 mL - 10 mL

Multi-channel tool, for cutting the O-rings on tip cones of multi-channel pipettes, for 5 – 100 µL or 15 – 300 µL pipettes

Multi-channel tool, for cutting the O-rings on tip cones of multi-channel pipettes, for 50 – 1,200 µL pipettes

Unlocking tool, to open multi-channel lower parts of 1,200 µL pipettes

Locking ring for single-channel pipettes, to prevent spring action in single-channel pipettes, for pipettes from 2.5 µL – 1,000 µL

Locking clip for 8-channel pipettes, to prevent spring action in multi-channel pipettes, 2 pieces

Locking clip for 12-channel pipettes, to prevent spring action in multi-channel pipettes, 3 pieces

O-ring, red, for multi-channel pipette lower parts, 5 – 100 µL, 15 – 300 µL (1 set = 24 pcs)

O-ring, red, for multi-channel pipette lower parts, 50 – 1,200 µL (1 set = 24 pcs)

Lower part made of PTFE (higher chemical resistance)

for Eppendorf Research® plus, single-channel, 5 mL, color code: violet

for Eppendorf Research® plus, single-channel, 1,000 µL, color code: blue

for Eppendorf Research® plus, single-channel, 10 mL, color code: turquoise

Order no.

[0030058607](#)

[0013022153](#)

[4920622009](#)

[4920623005](#)

[4920624001](#)

[3120639004](#)

[3120633006](#)

[3120636005](#)

[3120634002](#)

[3122610003](#)

[4860736000](#)

[4861605006](#)

[3120635009](#)

[3122612006](#)

[3122613002](#)

[3122611000](#)

[4860716009](#)

[3120642005](#)

[3120641009](#)

[3120646000](#)



Eppendorf Reference[®] 2

A premium pipette that delivers extraordinary precision and accuracy

Choose the Eppendorf Reference 2 mechanical pipette with ergonomic single-button operation and benefit from its high precision and accuracy with reduced operating efforts. Its smooth surface and full autoclavability guarantee efficient decontamination - making it the ideal companion when working under sterile conditions. Available as a single-channel pipette in fixed or variable volume, and as 8- and 12-channel pipettes - all with time-saving single-button operation. Once you have experienced this unique operating philosophy you will not want to change back!



Product features

- > Mechanical air-cushion pipette with outstanding precision and accuracy - operated with one button
- > With its innovative one-button operation, the Reference 2 allows fast and ergonomic handling with reduced operating efforts and active aerosol reduction. A clear haptic feedback helps to avoid accidental tip ejection
- > 4-digit display with magnifying window for quick and secure volume setting and identification (clearly visible from every angle), incl. volume lock



User-friendly temporary adjustment

For liquids other than aqueous solutions. Recommended settings are provided in the manual and you can easily and quickly reset to the manufacturer settings.



Exquisite stainless steel upper part

Equips the Reference 2 with outstanding robustness at potential impact sites. It includes quick volume setting and a secure volume lock.

Learn more about
the Reference 2:



[www.eppendorf.link/
reference2](http://www.eppendorf.link/reference2)





Eppendorf Reference[®] 2

Ordering information		Order no.
Description		
Eppendorf Reference[®] 2, 1-channel, fixed		
1 µL, dark gray	■	4925000014
2 µL, dark gray	■	4925000022
5 µL, medium gray	■	4925000030
10 µL, medium gray	■	4925000049
10 µL, yellow	■	4925000057
20 µL, light gray	■	4925000065
20 µL, yellow	■	4925000073
25 µL, yellow	■	4925000081
50 µL, yellow	■	4925000090
100 µL, yellow	■	4925000103
200 µL, yellow	■	4925000111
200 µL, blue	■	4925000120
250 µL, blue	■	4925000138
500 µL, blue	■	4925000146
1,000 µL, blue	■	4925000154
2 mL, red	■	4925000162
2.5 mL, red	■	4925000170

Ordering information		Order no.
Description		
Eppendorf Reference[®] 2, 1-channel, variable, incl. epT.I.P.S.[®] Box 2.0		
0.1 – 2.5 µL, dark gray	■	4924000010
0.5 – 10 µL, medium gray	■	4924000029
2 – 20 µL, light gray	■	4924000037
2 – 20 µL, yellow	■	4924000045
10 – 100 µL, yellow	■	4924000053
20 – 200 µL, yellow	■	4924000061
30 – 300 µL, orange	■	4924000070
100 – 1,000 µL, blue	■	4924000088
Eppendorf Reference[®] 2, 1-channel, variable, incl. epT.I.P.S.[®] sample bag		
0.25 – 2.5 mL, red	■	4924000096
0.5 – 5 mL, violet	■	4924000100
1 – 10 mL, turquoise	■	4924000118

Ordering information		Order no.
Description		
Eppendorf Reference[®] 2, 8-channel, variable, incl. epT.I.P.S.[®] Box 2.0		
0.5 – 10 µL, medium gray	■	4926000018
10 – 100 µL, yellow	■	4926000034
30 – 300 µL, orange	■	4926000050
Eppendorf Reference[®] 2, 12-channel, variable, incl. epT.I.P.S.[®] Box 2.0		
0.5 – 10 µL, medium gray	■	4926000026
10 – 100 µL, yellow	■	4926000042
30 – 300 µL, orange	■	4926000069



Eppendorf Reference[®] 2 Multi-packs



Ordering information

Description	Order no.
Eppendorf Reference[®] 2, 3-pack , 1-channel, variable, incl. 3x epT.I.P.S. [®] Box 2.0 and ballpoint pen	
Option 1: 0.5 – 10 µL, 10 – 100 µL, 100 – 1,000 µL	4924000908
Option 2: 2 – 20 µL yellow, 20 – 200 µL, 100 – 1,000 µL	4924000916
Eppendorf Reference[®] 2, 3-pack , 1-channel, variable, incl. 1x epT.I.P.S. [®] Box 2.0, 2x epT.I.P.S. sample bags and ballpoint pen	
Option 3: 100 – 1,000 µL, 0.5 – 5 mL, 1 – 10 mL	4924000924
Eppendorf Reference[®] 2, 6-pack , 1-channel, variable, incl. Pipette Carousel 2, 6x epT.I.P.S. [®] Box 2.0 and ballpoint pen	
0.1 – 2.5 µL, 0.5 – 10 µL, 2 – 20 µL (yellow), 10 – 100 µL, 20 – 200 µL, 100 – 1,000 µL	4924000940

Accessories

Description	Order no.
Reagent reservoir Tip-Tub , autoclavable reservoir for the aspiration of liquids with multi-channel pipettes, 1 set = 10 reservoirs and 10 lids	0030058607
Grease for pipettes , incl. lint-free applicators, to relubricate the piston or cylinder in pipette lower parts	0013022153
Protection filter , 2.5 mL, for Eppendorf Research [®] plus, Reference [®] 2 and Xplorer [®] (plus), 10 filters with 1 filter sleeve, for 2.5 mL pipettes, color code: red	4920622009
Protection filter , 5 mL, for Eppendorf Research [®] plus, Reference [®] 2 and Xplorer [®] (plus), 10 filters with 1 filter sleeve, for 5 mL pipettes, color code: violet	4920623005
Protection filter , 10 mL, for Eppendorf Research [®] plus, Reference [®] 2 and Xplorer [®] (plus), 10 filters with 1 filter sleeve, for 10 mL pipettes, color code: turquoise	4920624001
Adjustment seal ADJ, red , for Eppendorf Reference [®] 2, incl. pin for removing the inserted seal, 1 set = 5 pieces	4920626004
Safety plug, red , for Eppendorf Reference [®] 2, incl. pin for removing the inserted safety plug, 1 set = 5 pieces	4920625008
Adjustment tool , for Eppendorf Research [®] plus and Reference [®] 2, to change factory or temporary adjustment	3120633006
Pipette wrench 2 mL – 10 mL , to open single-channel pipette lower parts from 2 mL - 10 mL	3120634002
Multi-channel tool , for cutting the O-rings on tip cones of multi-channel pipettes, for 5 – 100 µL or 15 – 300 µL pipettes	3122610003
Lower part made of PTFE (higher chemical resistance)	
for Eppendorf Reference [®] 2, single-channel, 1,000 µL, color code: blue	4920627000
for Eppendorf Reference [®] 2, fixed, single-channel, 2 mL, color code: red	4921610004
for Eppendorf Reference [®] 2, single-channel, 2.5 mL, color code: red	4920629003
for Eppendorf Reference [®] 2, single-channel, 5 mL, color code: violet	4920633000
for Eppendorf Reference [®] 2, single-channel, 10 mL, color code: turquoise	4920636000
Locking ring for single-channel pipettes , to prevent spring action in single-channel pipettes, for pipettes from 2.5 µL – 1,000 µL	3120635009
O-ring , red, for multi-channel pipette lower parts, 5 – 100 µL, 15 – 300 µL (1 set = 24 pcs)	3122611000





Eppendorf Xplorer®/Eppendorf Xplorer® plus

Simple, fast and precise with untiring battery power – You deserve it!

People who give 100 % every day deserve the best tools and the best laboratory equipment. The Eppendorf Xplorer and Xplorer plus electronic pipettes are single-, 8-, 12-, 16- and 24-channel pipettes designed to aspirate and dispense liquid volumes from 0.5 µL to 10 mL, while eliminating many of the potential error risks associated with manual pipetting. With the Eppendorf Xplorer/Xplorer plus electronic pipette, your work achieves a new level of simplicity, precision and reproducibility. Also available as Move It® adjustable tip spacing multi-channel pipette (see page 32).



*All single-channel variants.

Product features

- > Electronic air-cushion pipette reaching new levels of simplicity, precision and reproducibility
- > Intuitive handling via multi-function rocker with »up is up« (aspiration) and »down is down« (dispensing) logic and selection dial for quick and easy mode selection
- > Self-explanatory color display without submenus and with ergonomic angle for optimal readability in every position

Applications

- > Automated pipetting of liquids (**Pip**) for forward pipetting
- > Manual pipetting (**Man**) for volume determination
- > Pipetting and mixing (**P/M**) for automated mixing of samples
- > Dispensing (**Dis**) for manual filling of plates, gels, and reaction vessels
- > Automatic dispensing (**Ads**) for automated filling of plates, gels, and reaction vessels
- > Multi aspiration (**Spc**): Pooling supernatants from different vessels¹⁾
- > Sequential dispensing and pipetting (**Spc**) for user-defined volume steps¹⁾
- > Reverse pipetting (**Spc**) for non-aqueous solutions¹⁾
- > Diluting (**Spc**) for preparation of dilution series¹⁾
- > Fix volume (**Fix**): Save up to 10 volumes for ease of operation¹⁾

¹⁾ Xplorer plus only

Keep your Xplorer
up to date with
software updates



[www.eppendorf.link/
software-downloads](http://www.eppendorf.link/software-downloads)



Learn more about
the Xplorer:







www.eppendorf.link/xplorer



Eppendorf Xplorer®

Ordering information		Order no.
Description		
Eppendorf Xplorer® , 1-channel, variable		
0.5 – 10 µL, medium gray		4861000015
1 – 20 µL, light gray		4861000017
5 – 100 µL, yellow		4861000023
10 – 200 µL, yellow		4861000027
15 – 300 µL, orange		4861000031
50 – 1,000 µL, blue		4861000040
0.1 – 2.5 mL, red		4861000044
0.2 – 5 mL, violet		4861000058
0.5 – 10 mL, turquoise		4861000066

Ordering information		Order no.
Description		
Eppendorf Xplorer® , 8-channel		
0.5 – 10 µL, medium gray		4861000104
5 – 100 µL, yellow		4861000120
15 – 300 µL, orange		4861000147
50 – 1,200 µL, green		4861000163

Ordering information		Order no.
Description		
Eppendorf Xplorer® , 12-channel		
0.5 – 10 µL, medium gray		4861000112
5 – 100 µL, yellow		4861000139
15 – 300 µL, orange		4861000155
50 – 1,200 µL, green		4861000171





Eppendorf Xplorer® plus

Ordering information

Description		Order no.
Eppendorf Xplorer® plus, 1-channel, variable		
0.5 – 10 µL, medium gray		4861000708
1 – 20 µL, light gray		4861000710
5 – 100 µL, yellow		4861000716
10 – 200 µL, yellow		4861000720
15 – 300 µL, orange		4861000724
50 – 1,000 µL, blue		4861000732
0.1 – 2.5 mL, red		4861000736
0.2 – 5 mL, violet		4861000740
0.5 – 10 mL, turquoise		4861000759

Ordering information

Description		Order no.
Eppendorf Xplorer® plus, 8-channel, variable		
0.5 – 10 µL, medium gray		4861000767
5 – 100 µL, yellow		4861000783
15 – 300 µL, orange		4861000805
50 – 1,200 µL, green		4861000821

Ordering information

Description		Order no.
Eppendorf Xplorer® plus, 12-channel, variable		
0.5 – 10 µL, medium gray		4861000775
5 – 100 µL, yellow		4861000791
15 – 300 µL, orange		4861000813
50 – 1,200 µL, green		4861000830

How to get started with Xplorer pipettes:



www.eppendorf.link/DiscoverXplorer



Eppendorf Xplorer® plus

Ordering information		
Description		Order no.
Eppendorf Xplorer® plus , 16-channel, variable		
1 – 20 µL, light pink	■	4861000778
5 – 100 µL, light yellow	■	4861000792

Ordering information		
Description		Order no.
Eppendorf Xplorer® plus , 24-channel, variable		
1 – 20 µL, light pink	■	4861000779
5 – 100 µL, light yellow	■	4861000793

Accessories		Order no.
Description		
Reagent reservoir Tip-Tub , autoclavable reservoir for the aspiration of liquids with multi-channel pipettes, 1 set = 10 reservoirs and 10 lids		0030058607
Lithium polymer rechargeable battery , for Eppendorf Xplorer® pipette family		4861601000
Lithium polymer rechargeable battery (small) , for Eppendorf Xplorer® connect		4861618000
Grease for pipettes , incl. lint-free applicators, to relubricate the piston or cylinder in pipette lower parts		0013022153
Power supply with plug adapters , for Eppendorf pipettes, multi-dispensers and pipette controllers, 100 – 240 VAC / 5 VDC		4986603005
Pipette wrench 2 mL – 10 mL , to open single-channel pipette lower parts from 2 mL - 10 mL		3120634002
Multi-channel tool , for cutting the O-rings on tip cones of multi-channel pipettes, for 5 – 100 µL or 15 – 300 µL pipettes		3122610003
Multi-channel tool , for cutting the O-rings on tip cones of multi-channel pipettes, for 50 – 1,200 µL pipettes		4860736000
Unlocking tool , to open multi-channel lower parts of 1,200 µL pipettes		4861605006
Locking ring for single-channel pipettes , to prevent spring action in single-channel pipettes, for pipettes from 2.5 µL – 1,000 µL		3120635009
Locking clip for 8-channel pipettes , to prevent spring action in multi-channel pipettes, 2 pieces		3122612006
Locking clip for 12-channel pipettes , to prevent spring action in multi-channel pipettes, 3 pieces		3122613002
O-ring , red, for multi-channel pipette lower parts, 5 – 100 µL, 15 – 300 µL (1 set = 24 pcs)		3122611000
O-ring , red, for multi-channel pipette lower parts, 50 – 1,200 µL (1 set = 24 pcs)		4860716009

Pipette Manager Connected Electronic Pipette System

Ordering information		Order no.
Description		
Pipette Manager , an external touch server enabling the communication with connected electronic pipettes.		1004000001
Eppendorf Xplorer® connect , WiFi module to connect pipette to the Pipette Manager		4861000970

These products are not available in all markets. Please check with your local sales organization, if the Pipette Manager has been released for sales in your country.





Eppendorf Pipette Holder System

Well within reach: the Eppendorf Pipette Holder System helps you to organize your lab

Save valuable bench space with the Eppendorf Pipette Holder System! With space for up to six single- or multi-channel pipettes, you can easily store all of your Eppendorf pipettes and multi-dispensers within easy reach. Our flexible carousels, stands and wall mount devices fit all current Eppendorf manual liquid handling instruments as well as most of their predecessors.



- > Pipette Carousel 2: Rotatable holder for all mechanical pipettes
- > Charger Carousel 2: Carousel with intelligent charging electronics, capacity for up to six instruments (charges four instruments at a time and all six in turn) and magnetic power connector for fast and easy connection



- > With Charger Stand 2, the Eppendorf Xplorer®/Xplorer® plus or Multipipette® E3/E3x is always fully charged and ready for use.
- > Pipette Stand 2 carries one pipette or multi-dispenser
- > Large rubber feet protect stands and carousels from liquids spilled on lab bench
- > Charger Stand 2 with cord wrap functionality for more convenience

DESIGN
AWARD

reddot design award

- > Place your pipette and Multipette where you need them: Mounted to a wall, on the shelf above your bench or inside a biological safety cabinet
- > Pictograms on the reversible holders allow for easy assignment of pipettes to their respective holder
- > Pipette holders are downwards compatible for Eppendorf Research and Reference pipettes

Ordering information

Description	Order no.
Pipette Carousel 2 , with holders for 6 Eppendorf Research®, Eppendorf Research® plus, Eppendorf Reference®, Eppendorf Reference® 2 or Biomaster®, additional pipette holders are optionally available	3116000015
Charger Carousel 2 , with charger shells for 6 Eppendorf Xplorer®/Xplorer® plus, mains/power adapter included, additional charger shells and pipette holders are optionally available	3116000023
Charger Stand 2 , for one Eppendorf Xplorer®/Xplorer® plus	3116000031
Charger Stand 2 , for one Multipette® E3/E3x or Multipette® stream/Xstream, operated with mains/power adapter supplied with Multipette® E3/E3x or Multipette® stream/Xstream	3116000040
Pipette Stand 2 , for one Multipette® M4, without charging functionality, additional pipette holders are optionally available	3116000058
Pipette Holder 2 , for one Multipette® E3/E3x or Multipette® stream/Xstream, for Pipette Carousel 2 or wall mounting, sticky tape included, without charging functionality	3116000139
Pipette Holder 2 , for one Eppendorf Research®, Eppendorf Research® plus, Eppendorf Reference®, Eppendorf Reference® 2 or Biomaster®, for Pipette Carousel 2 and Charger Carousel 2 or wall mounting, sticky tape included	3116000112
Pipette Holder 2 , for one Eppendorf Xplorer®/Xplorer® plus, for Pipette Carousel 2 or wall mounting, sticky tape included, without charging functionality	3116000120
Pipette Holder 2 , for one Multipette® M4, for Pipette Carousel 2 and Charger Carousel 2 or wall mounting, sticky tape included	3116000147
Charger Shell 2 , for one Eppendorf Xplorer®/Xplorer® plus, for Charger Carousel 2 (with charging functionality)	3116602007
Charger Shell 2 , for one Multipette® E3/E3x or Multipette® stream/Xstream, for Charger Carousel 2 (with charging functionality)	3116603003



The Perfect Fit – Eppendorf Pipette Tips

With respect to material, fit, design and operating forces, our pipette tips set standards. The close environment of each sample should be adapted to its specific quality and purity needs. This can involve a specific purity level or the absence of certain substances, but also stability, reliability of quality standard or geometry. Our epT.I.P.S. – Eppendorf Totally Integrated Pipetting System – have been developed to work in perfect combination with our pipettes. This results in reduced tip attachment and ejection forces while maintaining a complete seal between tip and pipette.

In the Eppendorf owned production facilities in the north of Germany, we can maintain the highest standards in the selection and processing of plastic materials. Ideal wetting properties, high transparency, and special certified purity levels are the visible expression of this production philosophy.

Sustainability is playing an increasingly important role also in the laboratory. This is why Eppendorf searched for more sustainable manufacturing materials in order to conserve resources and offers now also pipette tips made of bio-based polypropylene providing the same premium quality and purity our customers need for their experiments. For disposable Racks we have begun to manufacture the undersides from single-grade recycleate, knowing that pure PP recycleate has identical properties in terms of stability and safety as the previously used virgin PP. Purity and sterility of pipette tips are not compromised in any way.

How to reduce laboratory waste volume by choosing the right packaging format. Depending on their purity grade, epT.I.P.S. pipette tips and ep Dualfilter T.I.P.S. filter pipette tips are available in a number of different packaging formats.

It is precisely the different forms of packaging that generate large proportions of laboratory waste. This can be remedied by optimizing the packaging with regard to the type of use, but also by reducing the amount of manufacturing material required.

Our challenge in developing the new epT.I.P.S. packaging design

For special applications that require a high degree of integrity and purity, there is no alternative to the disposable packaging form. But our disposable racks also had potential for plastic savings. We were able to save up to 30 % polypropylene (PP) in the production of the epT.I.P.S. and ep Dualfilter T.I.P.S. Racks for pre-sterilized pipette tips. Additionally we redesigned the well-known epT.I.P.S. box – now epT.I.P.S. Box 2.0 – and at the same time optimized it for use with the new innovative Sterile Reload variants. Where possible this new form of packaging is the more sustainable and plastic-saving alternative to disposable racks while maintaining sterility and purity. In this case, additionally up to 54 % polypropylene (PP) is saved and at the same time the waste volume generated in the laboratory is reduced by about 30%.

Depending on their purity grade, epT.I.P.S. pipette tips from Eppendorf are available in a number of different packaging formats:



epT.I.P.S.® Reloads

- > Reduced waste as compared with disposable racks
- > The refill trays can be autoclaved up to 121 °C, in packaging and without foil, for subsequent use
- > The refill system, depending on tip size, is packaged as either dual-sided or in stack form



New



epT.I.P.S.® BioBased Sterile Reloads

- > available for epT.I.P.S.® BioBased Biopur®, ep Dualfilter T.I.P.S.® BioBased PCR clean/Sterile, ep Dualfilter T.I.P.S.® SealMax® Biopur®
- > Less waste – reduce your waste volume up to 30 % compared to disposable racks
- > Less raw material – reduced CO₂ by up to 54 % less raw material compared to disposable racks

Get all the details of our pipette tips portfolio!
Explore the eshop and get an overview!

www.eppendorf.link/tips





epT.I.P.S.® Box 2.0/epT.I.P.S.® Set

- > Contamination-free transfer of trays to stable working box
- > System optimized for use with multi-channel pipettes
- > Color-coded trays for simple identification of tips and pipette



epT.I.P.S.® Racks

- > Eppendorf Biopur® pipette tips in disposable Racks offer the highest biological purity grade
- > Ensured PCR clean, sterile, pyrogen-, ATP- and DNA-free
- > All pre-sterilized epT.I.P.S. and ep Dualfilter T.I.P.S. variants are available in Racks

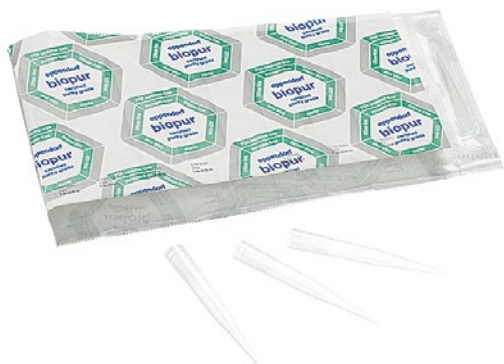

epT.I.P.S.® Singles

- > Eppendorf Biopur® pipette tip, individually wrapped
- > Ensured PCR clean, sterile, pyrogen-, ATP- and DNA-free
- > For use in pharmaceutical and food industry, molecular biology and cell technology



epT.I.P.S.® Standard

- > Original, high-quality Eppendorf pipette tips packaged in resealable bags
- > Available in sizes from 10 μ L to 10 mL in Eppendorf Quality purity grade
- > epT.I.P.S. Standard 200 μ L, 300 μ L and 1,000 μ L tips are also available color-coded yellow and blue





Eppendorf Purity Grades for Tips

epT.I.P.S.[®], ep Dualfilter T.I.P.S.[®] and ep Dualfilter T.I.P.S.[®] SealMax[®] stand for highest quality and purity

The high precision and accuracy of pipette tips and filter pipette tips is ensured by precise molding. Each lot of our pipette tips is subject to gravimetric measurement during final testing. Low wetting ensures reliable volume readings and minimal adhesion. Pipette tips made of PP (polypropylene). A relatively inert plastic characterized by low wettability as well as high dimensional and mechanical stability across a wide temperature range. Our tips are available in a variety of purity grades (See [purity grades table on page 49](#)).

Pure Quality at Eppendorf

www.eppendorf.link/purity



Eppendorf Certificate

Certificate of Purity – PCR clean

This package contains a high quality consumable manufactured under the PCR clean Eppendorf Purity Standard.

The Eppendorf PCR clean consumables are produced in a class 6 (according to VDI 2083) and a class 100,000 (according to U.S. Fed. Stand. 209 D) clean room environment.

For this product Eppendorf certifies the following [*]:

Free of detectable

- Human DNA
- DNase
- RNase
- PCR inhibitors

Quality control and subsequent certification is done by an independent laboratory (accredited by DAkkS). Lot-specific certificates are available on request or on the internet at www.eppendorf.com/certificates.

The certification comprises the following tests:

Human DNA Contamination Test

A PCR master mix is prepared using the QuantiTect[®] Sybr[®] Green PCR Kit (Qiagen[®]) and primer for the detection of human DNA. The primers amplify a 294 bp fragment present in more than 1x10⁶ copies per human cell. The master mix (15 µl) is added to 5 positive control vessels containing known amounts of human DNA (32, 16, 8, 4 and 2 pg in 10 µl H₂O) plus a negative control (10 µl DNA-free H₂O).

15 samples are rinsed one after another with DNA-free water. 10 µl of this solution is added to 15 µl master mix. PCR is done for 30 cycles.

The emittance of Sybr Green-induced fluorescence is detected in samples and controls. For the samples to pass certification, no fluorescence must be found corresponding to the negative control.

DNase Test

15 samples are rinsed one after another with DNA-free water. 17 µl of these solutions are mixed with 3 µl DNase-buffer containing 100 bp DNA-ladder in a DNase-free tube. A positive control is spiked with DNase, a negative control contains DNA-free water. All tubes are incubated for 24 h at 37 °C.

Page 1 of 2

www.eppendorf.com

Test Report – Eppendorf Biopur –

epT.I.P.S.[®] Racks 0.1 - 20 µL

6x 96 Eppendorf Tip
Eppendorf Biopur

Order no.: 0030 078.026 Cat. no.: 003007826
Eppendorf SE 22811 Hamburg - Germany Distributor: eppendorf.com
Email: ep@eppendorf.com Phone: +49 421 4207-100 Fax: +49 421 4207-199

* Human DNA Method: real-time PCR acc. to SOP 06680V2 Limit: < 2 pg less than one human cell	* PCR inhibition Method: real-time PCR acc. to SOP 100889V1 Limit: Less than 10 targets amplified
* Bacterial DNA Method: real-time PCR acc. to SOP 100551V1 Limit: < 50 fg less than 10 E. coli cells	* Sterility Method: Sterilization with SAL 10 ⁶ by 22 irradiation according DIN EN ISO 11137:2019 or E2 "ethylene oxide" * These are attached hereto to the standard method of verification for this product
* DNase Method: DNA Digestion acc. to SOP 100570V1 Limit: Not detectable (E.O.D. 1.0 x 10 ⁻⁶ Kunitz units)	* Endotoxin Method: Kinetic-chromogenic LAL test (Ph. Eur. 8.0 / 2.6.14) Limit: < 0.001 EU/ml
* RNase Method: RNA Digestion acc. to SOP 100571V1 Limit: Not detectable (E.O.D. 1.0 x 10 ⁻⁶ Kunitz units)	* ATP Method: Pre-sterilization test / Bioburden test (Ph. Eur. 8.0 / 2.6.12) Limit: < 0.5 x 10 ¹¹ mg

Customer: Eppendorf SE, Barkhausenweg 1, D-22339 Hamburg
Date of sample receipt / examination: 17.01.23
Testing of the above described lot showed conformity within the limits of detection.

Date of release: 20.01.23 Eppendorf - 2652 J. Weigel
Responsible number: Dipl.-Biol. Thomas Weigel (Head)

The test results refer exclusively to the items tested as arrived. The test report must not be copied partially without the approval of LADR GmbH.

page 1 of 1

LADR GmbH MVZ Bremen, Bereich Lebensmittel- & Umweltanalytik | Friedrich-Karl-Str. 22 | D-28203 Bremen | Germany
Phone: +49 421 4207-100 | Fax: +49 421 4207-199 | melok@laborzentrum-bremen.de | www.laborzentrum-bremen.de

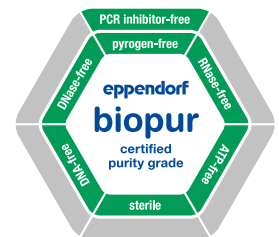
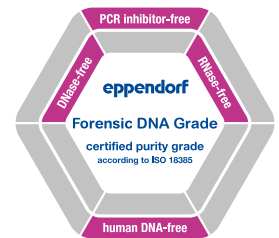
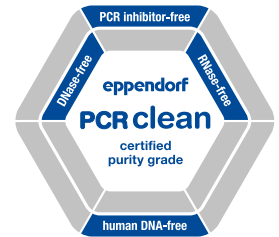



Pure quality

With the strictest control criteria, internally and externally monitored, we ensure the consistent high quality of our products – from lot to lot. Our consumables are available in a variety of purity qualities. Eppendorf Quality as well as more advanced purity grades:

“Sterile, Protein-free, PCR clean, Eppendorf Forensic DNA Grade, and Biopur®”. In addition to our internal process controls and general quality certificates, lot-specific certificates are provided by an external accredited laboratory for the Sterile, Protein-free, PCR clean, Eppendorf Forensic DNA Grade, and Biopur purity grades. This allows us to consistently meet our customer’s high demands when it comes to purity (www.eppendorf.link/purity). As a special service, we make the inspection certificate for each delivered lot available online (www.eppendorf.link/certificates).



www.eppendorf.link/PG_Guide

Purity grades	Eppendorf Quality	Eppendorf Sterile	Eppendorf PCR clean	Eppendorf PCR clean/Sterile	Eppendorf Forensic DNA Grade ³⁾	Biopur®
Eppendorf purity grades for tips						
Continuous quality control for the following relevant criteria:						
Function, tightness, precision	■	■	■	■	■	■
Low wetting	■	■	■	■	■	■
High chemical resistance	■	■	■	■	■	■
High thermal resistance	■	■	■	■	■	■
High transparency	■	■	■	■	■	■
Precisely shaped	■	■	■	■	■	■
Lot-specific certified¹⁾ for the following purity criteria:						
Pyrogen-free ⁴⁾ (endotoxin-free)		■		■		■
Sterile (Ph.Eur./USP)		■		■		■
DNA-free ⁴⁾ (Human DNA)			■	■	■	■
DNA-free ⁴⁾ (Bacteria DNA)						■
DNase-free ⁴⁾			■	■	■	■
RNase-free ⁴⁾			■	■	■	■
PCR-inhibitor-free ⁴⁾			■	■	■	■
ATP-free ⁴⁾						■
Eppendorf tips						
epT.I.P.S.® Standard, Box and Set	■					
epT.I.P.S.® Reloads	■		■			
epT.I.P.S.® BioBased Reloads						■
epT.I.P.S.® Racks		■ ²⁾				■
epT.I.P.S.® Singles						■
epT.I.P.S.® 384 Reload and Set	■		■			
ep Dualfilter T.I.P.S.®				■	■	
ep Dualfilter T.I.P.S.® BioBased				■		
ep Dualfilter T.I.P.S.® 384 Rack				■		
ep Dualfilter T.I.P.S.® SealMax®				■		
ep Dualfilter T.I.P.S.® SealMax® BioBased						■
Combitips advanced®	■	■ ²⁾	■		■	■
ViscoTip®	■					
epT.I.P.S.® Motion	■	■				
epT.I.P.S.® Motion filtertips			■	■		

¹⁾ Lot-specific certificate can be downloaded from www.eppendorf.com/certificates. ²⁾ Only available in North America. ³⁾ According to ISO 18385. ⁴⁾ Testing showed conformity within the detection limits





epT.I.P.S.[®]

Description

epT.I.P.S. pipette tips – Eppendorf Totally Integrated Pipetting System – the perfect combination with Eppendorf pipettes, resulting in reduced-force tip attachment and ejection with complete sealing.



Product features

- > New: epT.I.P.S.[®] BioBased Biopur[®] - made of bio-based PP - only available in the new Reload Variant for pre-sterilized pipette tips - help to reduce the usage of fossil oil-based manufacturing material, reduce the CO₂ footprint of your lab
- > New Reload variant for pre-sterilized pipette tips reduces the use of plastic up to 54 % and the plastic waste up to 30 % compared to our disposable Racks
- > Available in Eppendorf Quality and purity grades of PCR clean and Biopur[®]

Applications

- > Pipetting liquids
- > Dispensing liquids
- > Mixing liquids
- > Filling plates and reaction vessels
- > Filling gels for electrophoresis
- > Phase extraction and removal of supernatants
- > For applications in 384-microplate format we recommend using 16- or 24-channel pipettes together with epT.I.P.S. 384

epT.I.P.S.[®] Box 2.0 for epT.I.P.S.[®] Reloads



Product features

- > epT.I.P.S.[®] Box 2.0 – empty reusable boxes for tip volumes of 10 µL - 5 mL
- > epT.I.P.S.[®] Box 2.0 – all three sizes are available in Eppendorf Quality
- > Autoclavable at 121 °C (20 min.) for subsequent use

Ordering information

Description	Order no.
epT.I.P.S. [®] Box 2.0 for epT.I.P.S. [®] Reloads, empty box, does not include tips	
Eppendorf Quality, 10 – 300 µL	0030076249
Eppendorf Quality, 1,000 – 1,250 µL	0030076257
Eppendorf Quality, 1,250 µL L – 5 mL	0030076265



epT.I.P.S.[®] 384

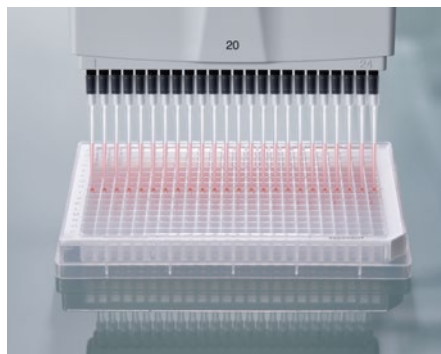

epT.I.P.S. 384 pipette tips with innovative SOFTattach technology for 16- and 24-channel as well as adjustable tip spacing pipettes

epT.I.P.S. 384 micropipette tips with the innovative SOFTattach technology are optimized for use with Eppendorf Research[®] plus and Xplorer[®] plus 16- and 24-channel pipettes, as well as 20 μ L and 100 μ L Move It[®] adjustable tip spacing pipettes. Process 384-well plates manually with the highest level of tip tightness and alignment but extremely low operating forces.

Product features

- > epT.I.P.S. 384 pipette tips build a system together with the Research plus and Xplorer plus 16- and 24-channel pipettes as well as 20 μ L and 100 μ L Move It adjustable tip spacing pipettes for utmost safety and reliability
- > Designed for a cone distance of 4.5 mm
- > Innovative SOFTattach technology allows for reliable tip fit and tightness



The elastic forming grooves

As soon as the tips are attached, they adapt perfectly to the shape of the tip cone. This SOFTattach technology allows the user to achieve perfect tip tightness and safety.

ep Dualfilter T.I.P.S.[®] 384

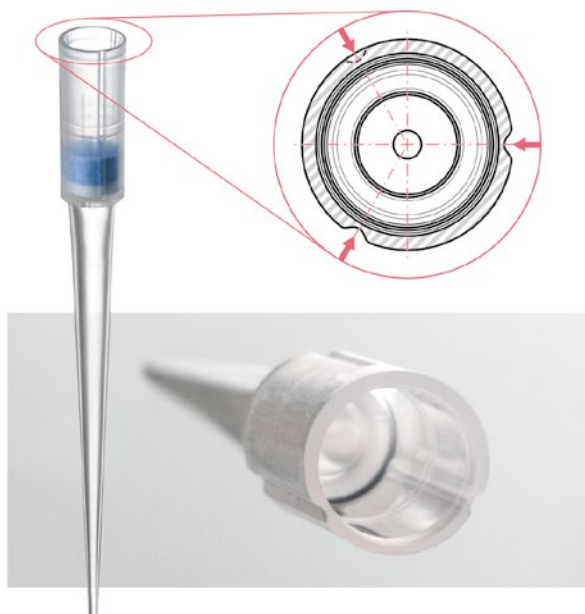

Description

ep Dualfilter T.I.P.S. 384 with the innovative SOFTattach technology are optimally coordinated to the Eppendorf 16- and 24-channel pipettes Research plus and Xplorer plus, as well as 20 μ L and 100 μ L Move It adjustable tip spacing pipettes. Process 384-well plates manually with highest level of filter pipette tip tightness and coaxiality but extraordinary low operating forces.

Product features

- > ep Dualfilter T.I.P.S. 384 pipette tips build a system together with the Research plus and Xplorer plus 16- and 24-channel pipettes as well as 20 μ L and 100 μ L Move It adjustable tip spacing pipettes for utmost safety and reliability
- > Innovative SOFTattach technology allows for reliable tip fit and tightness while operating forces are reduced to a minimum
- > Fill a whole 384-well plate without loosening pipette tips

An extraordinary tip alignment

All tips are perfectly aligned, making it easy and safe to transfer up to 24 samples simultaneously to the 384-well plate.





ep Dualfilter T.I.P.S.[®]



Description

ep Dualfilter T.I.P.S. Filter Tips - The ultimate protection of pipette and sample against unintentional and unnoticed contamination by aerosols, drops and splashes.

Product features

- > Dual protection against aerosols¹⁾ and biomolecules
- > Dual protection for pipette and sample
- > Free of PCR inhibitor additives

The unmistakable blue and white filter layers are made of flexible, hydrophobic material to fit perfectly in the tip cone and retain practically 100 % of all aerosols¹⁾ and biomolecules. This unique filtering effect is achieved using various well-defined pore sizes in the two filter layers.

¹⁾ An aerosol is a colloid of fine solid particles or liquid droplets, in air or another gas.

ep Dualfilter T.I.P.S.[®] SealMax[®]

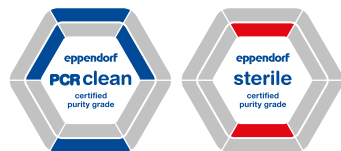

Description

ep Dualfilter T.I.P.S. SealMax Self-Sealing Filter Tips - The combination of the well known unique two-phase filter protection of sample and pipette with an innovative liquid and moisture barrier.

Product features

- > Reliable protection from liquids, aerosols¹⁾ and biomolecules
- > Certificate of filter efficiency of class ISO 25 E in accordance with DIN EN ISO 29463-5 available here
- > No PCR inhibiting additives

¹⁾ An aerosol is a colloid of fine solid particles or liquid droplets, in air or another gas.



epT.I.P.S.[®] Long



Description

epT.I.P.S. PipetteTips – Eppendorf Totally Integrated Pipetting System - the perfect combination with Eppendorf pipettes, resulting in reduced-force tip attachment and ejection with complete sealing.

Product features

- > Slim design of the extra long epT.I.P.S. and ep Dualfilter T.I.P.S. pipette tips
- > Always obtain high-quality results when pipetting from and into Eppendorf Tubes[®] 5.0 mL, conical tubes, cell culture flasks, deep wells and other deep vessels
- > The risk of touching the walls of deep vessels is minimized and risk of cross-contamination is minimized



Watch this video!





















www.eppendorf.link/eptips-video



Manual Liquid Handling

Guide



				
Volume range/epT.I.P.S.®	Standard/Bulk	Reloads	Reloads	Box
 dark gray	1,000 tips (2 bags × 500 tips)	960 tips (10 trays × 96 tips)	960 tips (10 trays × 96 tips)	1 reusable box × 96 tips
0.1 – 10 µL, 34 mm	0030000811	0030073371	0030073754	0030076125
				
 medium gray	1,000 tips (2 bags × 500 tips)	960 tips (10 trays × 96 tips)	960 tips (10 trays × 96 tips)	1 reusable box × 96 tips
0.1 – 20 µL, 40 mm	0030000838	0030073398	0030073770	0030076133
				
 light gray	1,000 tips (2 bags × 500 tips)	960 tips (10 trays × 96 tips)	960 tips (10 trays × 96 tips)	1 reusable box × 96 tips
0.5 – 20 µL L, 46 mm	0030000854	0030073410	0030073797	0030076141
				
 yellow	1,000 tips (2 bags × 500 tips)	960 tips (10 trays × 96 tips)	960 tips (10 trays × 96 tips)	1 reusable box × 96 tips
2 – 200 µL, 53 mm	0030000889	0030073436	0030073819	0030076150
 0030000870 yellow tips				
 orange	1,000 tips (2 bags × 500 tips)	960 tips (10 trays × 96 tips)	960 tips (10 trays × 96 tips)	1 reusable box × 96 tips
20 – 300 µL, 55 mm	0030000900	0030073452	0030073835	0030076168
 0030000897 yellow tips				
 blue	1,000 tips (2 bags × 500 tips)	960 tips (10 trays × 96 tips)	960 tips (10 trays × 96 tips)	1 reusable box × 96 tips
50 – 1,000 µL, 71 mm	0030000927	0030073479	0030073851	0030076176
 0030000919 blue tips				
 green	1,000 tips (4 bags × 250 tips)	960 tips (10 trays × 96 tips)	960 tips (10 trays × 96 tips)	1 reusable box × 96 tips
50 – 1,250 µL, 76 mm	0030000935	0030073495	0030073878	0030076184
				



Guide



New

Manual Liquid Handling

Set	Singles	Racks	Reloads
480 tips (5 trays × 96 tips), 1 reusable box 0030076290			
480 tips (5 trays × 96 tips), 1 reusable box 0030076303	100 tips, individually packed 0030010027	480 tips (5 racks × 96 tips) 0030075226	480 tips (5 trays × 96 tips) 0030075420 BioBased
480 tips (5 trays × 96 tips), 1 reusable box 0030076311			
480 tips (5 trays × 96 tips), 1 reusable box 0030076320	100 tips, individually packed 0030010043	480 tips (5 racks × 96 tips) 0030075234	480 tips (5 trays × 96 tips) 0030075439 BioBased
480 tips (5 trays × 96 tips), 1 reusable box 0030076338		480 tips (5 racks × 96 tips) 0030075242	480 tips (5 trays × 96 tips) 0030075447 BioBased
480 tips (5 trays × 96 tips), 1 reusable box 0030076346	100 tips, individually packed 0030010060	480 tips (5 racks × 96 tips) 0030075250	480 tips (5 trays × 96 tips) 0030075455 BioBased
480 tips (5 trays × 96 tips), 1 reusable box 0030076354		480 tips (5 racks × 96 tips) 0030075269	480 tips (5 trays × 96 tips) 0030075463 BioBased

Your local distributor: www.eppendorf.link/contactEppendorf UK Limited · Gateway 1000 · Whittle Way · Stevenage SG1 2FP · United Kingdom · sales@eppendorf.co.uk · www.eppendorf.com · www.eppendorf.link/eshop

Manual Liquid Handling

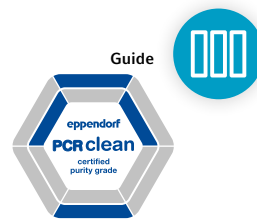

Volume range/epT.I.P.S.®

Standard/Bulk

Reloads

Reloads

■ dark green

1,000 tips (4 bags × 250 tips)

960 tips (10 trays × 96 tips)

960 tips (10 trays × 96 tips)

50 – 1,250 µL L, 103 mm

[0030000730](#)

[0030073630](#)

[0030073649](#)



■ red

500 tips (5 bags × 100 tips)

480 tips (10 trays × 48 tips)

480 tips (10 trays × 48 tips)

0.25 – 2.5 mL, 115 mm

[0030000951](#)

[0030073517](#)

[0030073894](#)



■ violet

500 tips (5 bags × 100 tips)

0.1 – 5 mL, 120 mm

[0030000978](#)



■ violet

300 tips (3 bags × 100 tips)

0.2 – 5 mL L, 175 mm

[0030000650](#)



■ turquoise

200 tips (2 bags × 100 tips)

0.5 – 10 mL, 165 mm

[0030000765](#)



■ turquoise

200 tips (2 bags × 100 tips)

0.5 – 10 mL L, 243 mm

[0030000781](#)



(Image reduced size)



Guide

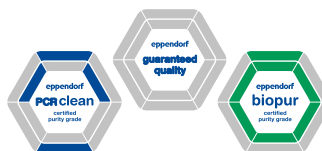

Manual Liquid Handling



New

Box	Set	Racks	Reloads
1 reusable box × 96 tips 0030076192		480 tips (5 racks × 96 tips) 0030075272 Biopur®	480 tips (5 trays × 96 tips) 0030075471 BioBased
1 reusable box × 48 tips 0030076206	240 tips (5 trays × 48 tips), 1 reusable box 0030076362	240 tips (5 racks × 48 tips) 0030075285 Biopur®	
1 reusable box × 24 tips 0030076214		120 tips (5 racks × 24 tips) 0030075293 Biopur® 0030071638 Eppendorf Quality 0030071662 PCR clean	
		120 tips (5 racks × 24 tips) 0030075307 Biopur® 0030071646 Eppendorf Quality	
		120 tips (5 racks × 24 tips) 0030075315 Biopur® 0030071654 Eppendorf Quality	



Manual Liquid Handling

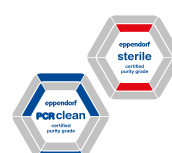

New

Volume range/
ep Dualfilter T.I.P.S.®/
ep Dualfilter T.I.P.S.® SealMax®

■ dark gray

0.1 – 10 µL S, 34 mm



Racks

960 tips (10 racks × 96 tips)

[0030078500](#)

[0030078691](#) SealMax



Reloads

960 tips (10 trays × 96 tips)

[0030081021](#)

BioBased

[0030081226](#)

SealMax BioBased

■ medium gray

0.1 – 10 µL M, 40 mm



960 tips (10 racks × 96 tips)

[0030078519](#)

[0030078810](#)

960 tips (10 trays × 96 tips)

[0030081030](#)

BioBased

■ light gray

0.5 – 20 µL L, 46 mm



960 tips (10 racks × 96 tips)

[0030078527](#)

[0030078705](#) SealMax



960 tips (10 trays × 96 tips)

[0030081048](#)

BioBased

[0030081234](#)

SealMax BioBased

■ yellow

2 – 20 µL, 53 mm



960 tips (10 racks × 96 tips)

[0030078535](#)

[0030078829](#)

960 tips (10 trays × 96 tips)

[0030081056](#)

BioBased

■ yellow

2 – 100 µL, 53 mm



960 tips (10 racks × 96 tips)

[0030078543](#)

[0030078713](#) SealMax



960 tips (10 trays × 96 tips)

[0030081064](#)

BioBased

[0030081242](#)

SealMax BioBased

■ yellow

2 – 200 µL, 55 mm



960 tips (10 racks × 96 tips)

[0030078551](#)

[0030078721](#) SealMax

[0030078837](#)



960 tips (10 trays × 96 tips)

[0030081072](#)

BioBased

[0030081250](#)

SealMax BioBased

■ orange

20 – 300 µL, 55 mm



960 tips (10 racks × 96 tips)

[0030078560](#)

[0030078730](#) SealMax



960 tips (10 trays × 96 tips)

[0030081080](#)

BioBased

[0030081269](#)

SealMax BioBased

■ blue

50 – 1,000 µL, 76 mm



960 tips (10 racks × 96 tips)

[0030078578](#)

[0030078748](#) SealMax

[0030078845](#)



960 tips (10 trays × 96 tips)

[0030081099](#)

BioBased

[0030081277](#)

SealMax BioBased

■ dark green

50 – 1,250 µL L, 103 mm



480 tips (5 racks × 96 tips)

[0030078594](#)

960 tips (10 trays × 96 tips)

[0030081102](#)

BioBased



Guide

Volume range/ ep Dualfilter T.I.P.S.®
■ red

0.25 – 2.5 mL, 115 mm

Racks

240 tips (5 racks × 48 tips)

[0030078586](#)

■ violet

0.1 – 5 mL, 120 mm

120 tips (5 racks × 24 tips)

[0030078616](#)

■ violet

0.2 – 5 mL L, 175 mm

120 tips (5 racks × 24 tips)

[0030078624](#)

■ turquoise

0.5 – 10 mL L, 243 mm

100 tips, individually packed



[0030077598](#)

(Image reduced size)

Your local distributor: www.eppendorf.link/contactEppendorf UK Limited · Gateway 1000 · Whittle Way · Stevenage SG1 2FP · United Kingdom · sales@eppendorf.co.uk · www.eppendorf.com · www.eppendorf.link/eshop



Tips for 384-Well Pipetting Solutions

Volume range/epT.I.P.S.® 384	Reloads	Reloads	Set
light pink 0.1 – 20 µL, 42 mm 	3,840 tips (10 trays × 384 tips) 0030076001	3,840 tips (10 trays × 384 tips) 0030076044	1,920 tips (5 trays × 384 tips), 1 reusable box 0030076273
light yellow 5 – 100 µL, 53 mm 	3,840 tips (10 trays × 384 tips) 0030076010	3,840 tips (10 trays × 384 tips) 0030076052	1,920 tips (5 trays × 384 tips), 1 reusable box 0030076281

Combination of Pipette Tips and Pipettes

	0.1 – 10 µL, dark gray	0.1 – 10 µL M, medium gray	0.1 – 20 µL, medium gray	0.5 – 20 µL L, light gray	0.1 – 20 µL, light pink	5 – 100 µL, light yellow	2 – 20 µL, yellow	2 – 100 µL, yellow	2 – 200 µL, yellow
epT.I.P.S.®	■		■	■	■				■
ep Dualfilter T.I.P.S.®	■	■		■	■	■	■	■	■
ep Dualfilter T.I.P.S.® SealMax®	■			■				■	■
Fixed volume, single-channel pipettes									
10 µL	■ ●	■	■	●					
20 µL	■		●	■					
10 µL	■						■	■	■
20 µL	■						■	■	■
25 µL/50 µL/100 µL	■							■	■
200 µL	■								■
200 µL/250 µL/500 µL/1,000 µL	■								■
Variable volume, single-, 8- and 12-channel pipettes									
0.1 – 2.5 µL	■ ■	●	●						
0.5 – 10 µL	■ ●	■	■	●					
2 – 20 µL	■ ◆	◆	●	■					
2 – 20 µL	■						■	■	■
10 – 100 µL	■						◆	■	■
20 – 200 µL	■						◆	◆	■
30 – 300 µL	■						◆	◆	◆
100 – 1,000 µL	■								
120 – 1,200 µL	■								
0.25 – 2.5 mL	■								
0.5 – 5 mL	■								
1 – 10 mL	■								
Variable volume, 16- and 24-channel pipettes									
1 – 20 µL	■				■				
5 – 100 µL	■					■			
Move It®, variable volume, 4-, 6-, 8- and 12-channel pipettes									
1 – 20 µL	■				■				
5 – 100 µL	■					■			
30 – 300 µL	■						◆	◆	◆
120 – 1,200 µL	■								

■ Test tip (other tips may require adjustment) ● Full volume range ◆ Limited volume range



Volume range/ep Dualfilter T.I.P.S.® 384

■ light pink

0.1 – 20 µL, 42 mm



Racks

3,840 tips (10 racks × 384 tips)

[0030078853](#)

■ light yellow

5 – 100 µL, 53 mm

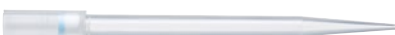

3,840 tips (10 racks × 384 tips)

[0030078861](#)

20 – 300 µL, orange	50 – 1,000 µL, blue	50 – 1,250 µL, green	50 – 1,250 µL L, dark green	0.25 – 2.5 mL, red	0.1 – 5 mL, violet	0.2 – 5 mL L, violet	0.5 – 10 mL, turquoise	0.5 – 10 mL L, turquoise
■	■	■	■	■	■	■	■	■
■	■		■	■	■	■	■	■
■	■							
●								
●								
●								
●								
	■	●	●					
●								
●								
●								
■								
	■	●	●					
		●	■					
				■				
					■			
						●		
							■	
								●
■								
		●						
			■					



Manual Liquid Handling

Guide



Eppendorf Reference® 2	0.1 – 10 µL, dark gray	0.1 – 10 µL M, medium gray	0.1 – 20 µL, medium gray	0.5 – 20 µL L, light gray	2 – 20 µL, yellow	2 – 100 µL, yellow	2 – 200 µL, yellow	20 – 300 µL, orange
epT.I.P.S.®	■		■	■			■	■
ep Dualfilter T.I.P.S.®	■	■		■	■	■	■	■
ep Dualfilter T.I.P.S.® SealMax®	■			■		■	■	■
Fixed volume, single-channel pipettes								
1 µL/2 µL	■	●	●					
5 µL/10 µL	■	■	■	●				
20 µL	■		●	■				
10 µL	■				■		■	●
20 µL	■				■		■	●
25 µL/50 µL/100 µL	■					■	■	●
200 µL	■						■	●
200 µL/250 µL/500 µL/1,000 µL	■							
2 mL/2.5 mL	■							
Variable volume, single-, 8- and 12-channel pipettes								
0.1 – 2.5 µL	■	●	●					
0.5 – 10 µL	■	■	■	●				
2 – 20 µL	■	◆	●	■				
2 – 20 µL	■				◆	◆	■	●
10 – 100 µL	■				◆	■	■	●
20 – 200 µL	■				■	■	■	●
30 – 300 µL	■				◆	◆	◆	■
100 – 1,000 µL	■							
0.25 – 2.5 mL	■							
0.5 – 5 mL	■							
1 – 10 mL	■							

■ Test tip (other tips may require adjustment) ● Full volume range ◆ Limited volume range

Eppendorf Xplorer®/ Eppendorf Xplorer® plus/ Eppendorf Xplorer® plus Move It®	0.1 – 10 µL, dark gray	0.1 – 10 µL M, medium gray	0.1 – 20 µL, medium gray	0.5 – 20 µL L, light gray	0.1 – 20 µL, light pink	5 – 100 µL, light yellow	2 – 20 µL, yellow	2 – 100 µL, yellow	2 – 200 µL, yellow
epT.I.P.S.®	■		■	■	■				■
ep Dualfilter T.I.P.S.®	■			■				■	■
ep Dualfilter T.I.P.S.® SealMax®	■			■				■	■
Variable volume, single-, 8- and 12-channel pipettes									
0.5 – 10 µL	■	●	■	●					
1 – 20 µL	■	◆	●	■					
5 – 100 µL	■						◆	■	■
10 – 200 µL	■						◆	◆	■
15 – 300 µL	■						◆	◆	◆
50 – 1,000 µL	■								
50 – 1,200 µL	■								
0.1 – 2.5 mL	■								
0.2 – 5 mL	■								
0.5 – 10 mL	■								
Variable volume, 16- and 24-channel pipettes									
1 – 20 µL	■				■				
5 – 100 µL	■					■			
Move It®, variable volume, 4-, 6-, 8- and 12-channel pipettes									
1 – 20 µL	■				■				
5 – 100 µL	■					■			
15 – 300 µL	■						◆	◆	◆
50 – 1,200 µL	■								

■ Test tip (other tips may require adjustment) ● Full volume range ◆ Limited volume range

LiquidPro® Positive Displacement System

New Pipette – New Perspective

Do you know the struggles of pipetting highly viscous (e.g., glycerol), volatile (e.g., ethanol), or dense liquids? When reproducible pipetting results really matter, even the most reliable air-cushion pipette has its limitations when faced with challenging liquids and fluctuating temperature or humidity.

To ensure precise and accurate pipetting independent of the liquid type and environmental conditions, a positive displacement pipetting system is the preferred choice. In this system, the piston is integrated into the tip and in direct contact with the liquid. As a result, the flow properties and wetting behavior of the liquid are of lesser importance. This makes the positive displacement pipetting system ideal for handling challenging liquids found in a variety of lab applications or for working with hazardous substances.

Introducing the new LiquidPro®: a highly ergonomic positive displacement pipetting system designed to address the pain of handling challenging liquids and to take your pipetting reproducibility to a new level. With 3 pipettes and 5 tip volumes, the LiquidPro system covers the volume range of 1 μL to 1,000 μL .

Whether you need to pipette highly viscous, dense, hot, cold, corrosive, or hazardous liquids, the new LiquidPro pipetting system ensures optimized precision and accuracy – no matter who uses it in the lab. Test it yourself to gain a new perspective on pipetting.

Coming
Soon

Versatility

Save time and money: Don't change the pipette, simply change between two tip sizes. Identify your volume using the Eppendorf color code.

Reproducibility

The positive displacement principle enables precise and accurate pipetting of challenging liquids for continuous reproducibility of your results.

Ergonomics

Ergonomic pipetting made easy. Experience low operating forces and an ingenious pipetting lever design that lets your thumb relax between aspirating and dispensing steps.



Video: Why positive displacement?

www.eppendorf.link/pipetting-systems



Designed to maximize user comfort, LiquidPro positive displacement pipettes, in conjunction with LiquidPro tips, offer high precision when pipetting non-aqueous liquids such as oils, blood, glycerol, ethanol, and more. The LiquidPro system not only ensures reproducible results even when used by inexperienced lab scientists but also safeguards both the pipette and its user against contamination. With just three pipettes, the LiquidPro system covers a volume range of 1 to 1,000 μL . Two out of the three pipettes incorporate a groundbreaking 2-in-1 design. This design allows the 2-in-1 pipettes to be used for two different volume ranges, which are easily selected by attaching the respective color-coded tip.



With their integrated piston, LiquidPro pipette tips ensure precise pipetting of the desired volume, regardless of the liquid's physical properties (e.g., viscosity, volatility, density, temperature). This guarantees high-precision dispensing, irrespective of the flow characteristics of your sample, and enables safe handling of infectious liquids due to the hermetic seal in the tips. The color-coded pistons allow for quick identification of the appropriate tip for your pipette. The design of LiquidPro pipette cones and tips

facilitates effortless attachment and secure fit, requiring minimal ejection forces. The tips' elongated and slender design ensures compatibility with a wide range of vessels.

LiquidPro tips are available in five different volume ranges, offered in Eppendorf Quality or Biopur®, which are specifically tailored to meet the stringent requirements of the pharmaceutical, medical, and food industries.





Multipette® M4



Aspirate liquid once and dispense up to 100 times without tip refill

Say goodbye to tedious, long serial pipetting tasks! The Multipette M4 pipette from Eppendorf is ideal for repetitive dispensing of volumes in long series without the need for repeated liquid aspiration. In combination with Combitips® advanced dispenser tips, even viscous or volatile liquids that are difficult to pipette are no problem for the Multipette. With hermetically sealed tips, the system also offers a high level of safety for handling of infectious, toxic or radioactive liquids.

Product features

- > Mechanical positive displacement multi-dispenser: fill the tip once and dispense up to 100 times without a refill
- > Automatic Combitips® advanced recognition eliminates time consuming volume calculations
- > Easy-to-read display guarantees stress-free and intuitive operation with a digital display of the dispensing volume

Applications

- > Repetitive dispensing of volumes in long series such as tube or plate filling, aliquoting reagents and kit usage
- > Safe dispensing of toxic, radioactive and other hazardous liquids
- > Precise and accurate dispensing of viscous solutions (e.g. glycerol) or liquids with high vapor pressure (e.g. ethanol)

Video: Air cushion & positive displacement systems



www.eppendorf.link/pipetting-systems

Combitips® advanced/Multipette® M4 technical data



www.eppendorf.link/MultipetteM4-data

Ordering information

Description	Order no.
Multipette® M4 , 1-channel, incl. 1x Combitips® advanced 2.5 mL (green) tip and Pipette Holder 2, 1 µL – 10 mL	4982000012
Multipette® M4 Starter Kit , 1-channel, incl. Combitips® advanced Box, Combitips® advanced assortment pack (1 tip of each size) and Pipette Holder 2, 1 µL – 10 mL	4982000314
Pipette Holder 2 , for one Multipette® M4, for Pipette Carousel 2 and Charger Carousel 2 or wall mounting, sticky tape included	3116000147
Battery CR2032 , for Multipette® M4, 1 piece	4980215003



Multipette® E3/Multipette® E3x



Precise, safe, versatile and a dream to use over a long pipetting day!

These electronic dispensers combine easy handling during dispensing with a broad range of features! The Multipette E3x dispenser offers additional high-end applications, such as titration and aspirating of supernatants or sequential dilutions. In combination with the Combitips® advanced pipette tips, it is an essential lab tool for all kind of liquid handling.

Product features

- > Electronic positive displacement dispenser with several functions e.g. for dilution series, titration, automatic dispensing into microplates and vessel series
- > Automatic Combitips® advanced pipette tip recognition: Eliminates time-consuming volume calculations, avoiding incorrect dispensing volumes
- > Ergonomic one-button tip ejector: For one-handed operation and contact-free Combitips® advanced pipette tip ejection

Applications

- > Dispensing (**Dis**) or Automatic dispensing (**Ads***) for repetitive (*automated) dispensing of set volumes in long series such as tube or plate filling, aliquoting reagents and kit usage
- > Pipetting (**Pip**) for refilling of liquids
- > Sequential dispensing (**Seq**) to create dilution series¹⁾
- > Aspiration (**Asp**) for pooling of supernatants from different vessels¹⁾
- > Aspirate and dispensing (**A/D**) for pooling and volume determination with subsequent dispensing¹⁾
- > Titration (**Ttr**) for controlled dropwise dispensing and concentration determination¹⁾

¹⁾ Multipette® E3x only

Keep your E3/E3x up to date with the Pipette Software Update Tool



www.eppendorf.link/software-downloads

Combitips® advanced/Multipette® E3 technical data



www.eppendorf.link/MultipetteE3-data

Ordering information

Description	Order no.
Multipette® E3 , 1-channel, incl. charging cable and Combitips® advanced assortment pack (1 tip of each size), 1 µL – 50 mL	4987000010
Multipette® E3 bundle with charger stand , 1-channel, incl. charging cable, Charger Stand 2 and Combitips® advanced assortment pack (1 tip of each size), 1 µL – 50 mL	4987000371
Multipette® E3x , 1-channel, incl. charging cable and Combitips® advanced assortment pack (1 tip of each size), 1 µL – 50 mL	4987000029
Multipette® E3x bundle with charger stand , 1-channel, incl. charging cable, Charger Stand 2 and Combitips® advanced assortment pack (1 tip of each size), 1 µL – 50 mL	4987000380
Pipette Holder 2 , for one Multipette® E3/E3x or Multipette® stream/Xstream, for Pipette Carousel 2 or wall mounting, sticky tape included, without charging functionality	3116000139
Lithium ion rechargeable battery , for Multipette® E3/E3x and Multipette (X)stream	4986602009
Power supply with plug adapters , for Eppendorf pipettes, multi-dispensers and pipette controllers, 100 – 240 VAC / 5 VDC	4986603005



Your local distributor: www.eppendorf.link/contact

Eppendorf UK Limited · Gateway 1000 · Whittle Way · Stevenage SG1 2FP · United Kingdom · sales@eppendorf.co.uk · www.eppendorf.com · www.eppendorf.link/eshop



Combitips® advanced



Description

Optimize your workflows involving plates or large series of other vessels with Combitips advanced dispenser tips and accurately and precisely pipette both viscous and volatile liquids. These positive displacement pipette tips are your consumable of choice for all Multipette® multi-dispenser pipettes from Eppendorf and offer a variety of advantages in comparison to their predecessor Combitips plus. Available in nine volume sizes (0.1 mL – 50 mL), Combitips advanced have a maximum range of dispensing volumes with increments as low as 100 nanoliters depending on the Multipette model used.

Product features

- > Combitips® advanced tips are the ideal consumable choice for all Multipette® multi-dispenser pipettes from Eppendorf
- > The 9 volume sizes (0.1 mL – 50 mL) offer a maximum range of dispensing volumes with increments as low as 100 nanoliters depending on the Combitips® advanced used
- > Elongated Combitips® advanced in volumes 2.5 mL, 5.0 mL and 10 mL make it possible to reach the bottom of the most common laboratory vessels

Applications

- > Positive displacement principle (comparable to a syringe)
- > High-precision dispensing regardless of the physical properties of the liquid (like e.g. viscosity, volatility, density or temperature)
- > Prevents aerosol contamination with hermetically sealed piston for secure dispensing
- > Provides protection from radioactive and toxic substances
- > Quick dispensing of long series with precise, repeated dispensing of identical volumes (with Multipette® hand dispensers)

ViscoTip®



Easily master the highest viscosity liquids with your Multipette® from Eppendorf!

The latest member of the Combitips® advanced dispenser tip family, ViscoTip positive displacement tips, are specifically designed and optimized for handling high viscosity liquids up to 14,000 mPa*s such as glycerol 99.5 %, Tween®, oils, creams, shampoos, nail polish - even honey. So, if you need to dispense high viscosity liquids and you want to do it with ease, turn to ViscoTip.

Product features

- > Specialized for liquids with a dynamic viscosity from 200 mPa*s to 14,000 mPa*s
- > For dispensing volumes from 100 µL to 10 mL in increments of 10 µL
- > Make life easier for your instrument: The new design of the tip means significantly lower operation forces are used, thus it speeds up work and reduces energy consumption

Applications

- > Positive displacement principle (comparable to a syringe)
- > For highly viscous liquids such as glycerol 99.5 %, Tween®, oils, creams, shampoos or honey
- > Quick dispensing of long series with precise, repeated dispensing of identical volumes (with Multipette hand dispensers)



Ordering information

Combitips® advanced	Color code	Eppendorf Quality 100 pcs. (4 bags × 25 pcs.)	PCR clean 100 pcs. (4 reclosable bags × 25 pcs.)	Biopur® 100 pcs., individually blister- wrapped	Forensic DNA Grade 100 pcs., individually blister- wrapped
0.1 mL	<input type="checkbox"/> white	0030089405	0030089766	0030089618	
0.2 mL	<input type="checkbox"/> light blue	0030089413	0030089774	0030089626	
0.5 mL	<input type="checkbox"/> violet	0030089421	0030089782	0030089634	
1.0 mL	<input type="checkbox"/> yellow	0030089430	0030089790	0030089642	0030089855
2.5 mL	<input type="checkbox"/> green	0030089448	0030089804	0030089650	0030089863
5.0 mL	<input type="checkbox"/> blue	0030089456	0030089812	0030089669	0030089871
10 mL	<input type="checkbox"/> orange	0030089464	0030089820	0030089677	
25 mL ¹⁾	<input type="checkbox"/> red	0030089472	0030089839	0030089685	
50 mL ¹⁾	<input type="checkbox"/> light gray	0030089480	0030089847	0030089693	
ViscoTip®					
10 mL	<input type="checkbox"/> orange	0030089502			
Accessories					
Adapter advanced					
25 mL, autoclavable, 1 piece	<input type="checkbox"/> red	0030089715			
25 mL, autoclavable, 7 pcs., individually blister-wrapped	<input type="checkbox"/> red			0030089731	
50 mL, autoclavable, 1 piece	<input type="checkbox"/> light gray	0030089723			
50 mL, autoclavable, 7 pcs., individually blister-wrapped	<input type="checkbox"/> light gray			0030089740	
Combitips® advanced Box 2.0 , empty box for 8 Combitips® advanced (0.1 – 10 mL), Eppendorf Quality, 1 piece. Replaces order no. 0030089758.		0030089952			
Combitips® advanced Assortment Pack , contains one Combitips® advanced sample of each size and Adapter advanced 25 and 50 mL, Eppendorf Quality		0030089936			

¹⁾ 4 boxes of 25 pcs. each. Each box containing one adapter.





Eppendorf Varitips® for Varipette®

Handle challenging liquid handling tasks with ease! The Varipette® 4720 is a large volume, positive displacement pipette that is optimized for lab work with viscous or volatile liquids. Ideal to safely aspirate liquids from large bottles or tall, narrow vessels when using the Eppendorf Varitips® S system (figures 2 & 3) or from beakers using the Varitips® P pipette tips (figure 1).

The Varipette was discontinued in 2024, Varitips continue to be available.



Combination	Volume range	Volume	Rel. systematic error ¹⁾	Abs. systematic error ¹⁾	Rel. random error ¹⁾	Abs. random error ¹⁾
Varipette 4720 and Varitips S system	2.5 – 10 mL	2.5 mL	±1.0 %	0.025 mL	±0.2 %	0.005 mL
		5 mL	±0.4 %	0.02 mL	±0.2 %	0.01 mL
		10 mL	±0.3 %	0.03 mL	±0.2 %	0.02 mL
Varipette 4720 and Varitips P	1 – 10 mL	1 mL	±0.6 %	0.006 mL	±0.2 %	0.002 mL
		5 mL	±0.5 %	0.025 mL	±0.1 %	0.005 mL
		10 mL	±0.3 %	0.03 mL	±0.1 %	0.01 mL

¹⁾ The error data, according to EN ISO 8655, only apply if original Eppendorf tips are used. Technical specifications are subject to change. Errors and omissions excepted.

Ordering information

Description	Order no.
Eppendorf Varitips® P , to remove liquid from smaller vessels, 100 pcs.	0030048130
Eppendorf Varitips® S Starter Kit , to remove liquid from narrow-necked vessels and measuring flasks, consisting of 100 Maxitips, 10 dispensing parts, 10 valves	0030050525
Eppendorf Varitips® S , graduated, 200 pcs.	0030050568
Eppendorf Varitips® S valve , 100 pcs.	0030050541
Eppendorf Varitips® S dispensing part , 30 pcs.	0030050533
Wall mount for Varipette® 4720 & Multipette® plus , with adhesive surface	4981203009



Eppendorf Top Buret



Continuous and pulse-free manual titration

The innovative Eppendorf Top Buret sets new standards in manual liquid titration. Its pulse-free dispensing technique means that exact volumes can be dispensed continuously, making titration simple, safe and precise. And with a user-friendly display and simple control features, this extremely sturdy digital bottle-top burette is really easy to use.

Product features

- > Bottle-top burette with continuous, pulse-free dispensing technology for manual titration
- > Digital display ranging from 0.01 mL to 999.9 mL, dosing rates: Model M: 2.5 mL per turn, Model H: 5 mL per turn
- > Recirculation valve with valve lever

Ordering information

Description	Order no.
Eppendorf Top Buret M , manual bottle-top buret with discharge valve, telescopic aspiration tube and variable discharge tube, 2.5 mL per turn, digital display ranging from 0.01 – 999.9 mL, for 45 mm bottle thread, incl. 3 PP adapters for 40/38/32 mm threads, 2 micro batteries 1.5 V, certificate of conformity	4965000017
Eppendorf Top Buret H , manual bottle-top buret with discharge valve, telescopic aspiration tube and variable discharge tube, 5 mL per turn, digital display ranging from 0.01 – 999.9 mL, for 45 mm bottle thread, incl. 3 PP adapters for 40/38/32 mm threads, 2 micro batteries 1.5 V, certificate of conformity	4965000025

Accessories

Description	Order no.
Drying tube , for Eppendorf Top Buret, without drying agent	4960851000
Telescopic aspirating tube , for Eppendorf Top Buret, for 2.5 mL, 5 mL, 10 mL, 25 mL, 50 mL, 100 mL	4960805009
Batteries (2 pcs.) , for Eppendorf Top Buret, LR03/AAA, 1.5 V	4965625009
Bottle thread adapter , PP, from GL 32 to GL 25	4960800040
Bottle thread adapter , PP, from GL 32 to GL 27	4960800139
Bottle thread adapter , PP, from GL 32 to GL/S 28	4960800058
Bottle thread adapter , PP, from GL 45 to GL 32	4960800120
Bottle thread adapter , PP, from GL 45 to GL 38	4960800155
Bottle thread adapter , PP, from GL 45 to S 40	4960800147
Bottle thread adapter , PP, from GL 32 to NS 19/26	4960800082
Bottle thread adapter , PP, from GL 32 to NS 24/29	4960800090
Bottle thread adapter , PP, from GL 32 to NS 29/32	4960800104

Watch how to properly use the Top Buret



www.eppendorf.link/buret





Varispenser® 2/Varispenser® 2x



Safe and easy dispensing of liquids from bottles without compromise

Need a bottle-top dispenser for aggressive solutions such as acids, solutions or bases? The Eppendorf bottle-top dispensers Varispenser 2 and Varispenser 2x allow you to safely dispense liquids from a wide range of bottles without reagent waste and are ideal for conveniently dispensing aliquots from large supply bottles. Chemically resistant and autoclavable, their tight seal provides protection against caustic media.

Product features

- > Bottle-top dispenser with standard GL 45 thread for most common bottle threads in all sizes
- > Safety valve balls in discharge valve prevent leakage when discharge tube is not mounted
- > Air vent cap can be unscrewed for easy assembly of drying tube

Applications

- > Liquid dispensing directly from supply bottles or other big laboratory vessels containing aqueous liquids, lyes, acids, bases or solvents

Learn more in
our White Paper



www.eppendorf.link/WP-Varispenser

Varispenser® 2/
Varispenser® 2x
technical data



[www.eppendorf.link/
Varispenser-data](http://www.eppendorf.link/Varispenser-data)



Ordering information

Description	Order no.
Varispenser® 2 , 1-channel, bottle-top dispenser with telescopic intake tube (length 125 – 240 mm)	
0.2 – 2 mL, incl. adapters GL 25, GL 28/S 28, GL 32, GL 38, S 40	4966000010
0.5 – 5 mL, incl. adapters GL 25, GL 28/S 28, GL 32, GL 38, S 40	4966000029
1 – 10 mL, incl. adapters GL 25, GL 28/S 28, GL 32, GL 38, S 40	4966000037
Varispenser® 2 , 1-channel, bottle-top dispenser with telescopic intake tube (length 170 – 330 mm)	
2.5 – 25 mL, incl. adapters GL 32, GL 38, S 40	4966000045
5 – 50 mL, incl. adapters GL 32, GL 38, S 40	4966000053
10 – 100 mL, incl. adapters GL 32, GL 38, S 40	4966000061
Varispenser® 2x , 1-channel, bottle top dispenser with recirculation valve and telescopic intake tube (length 125 – 240 mm)	
0.2 – 2 mL, incl. adapters GL 25, GL 28/S 28, GL 32, GL 38, S 40	4967000014
0.5 – 5 mL, incl. adapters GL 25, GL 28/S 28, GL 32, GL 38, S 40	4967000022
1 – 10 mL, incl. adapters GL 25, GL 28/S 28, GL 32, GL 38, S 40	4967000030
Varispenser® 2x , 1-channel, bottle top dispenser with recirculation valve and telescopic intake tube (length 170 – 330 mm)	
2.5 – 25 mL, incl. adapters GL 32, GL 38, S 40	4967000049
5 – 50 mL, incl. adapters GL 32, GL 38, S 40	4967000057
10 – 100 mL, incl. adapters GL 32, GL 38, S 40	4967000065

Accessories

Description	Order no.
Drying tube , for Varispenser® 2/2x, without filling, including sealing washer (PTFE)	4966509002
Ventilation screw , for microfilters with Luer connector, PP, with PTFE sealing washer	4966511007
Ventilation screw , for Varispenser® 2/2x, PP	4966601006
Discharge tube , for Varispenser® 2/2x, spiraled, for 2 mL, 5 mL, 10 mL	4966501001
Discharge tube , for Varispenser® 2/2x, spiraled, for 25 mL, 50 mL, 100 mL	4966502008
Telescopic aspirating tube , FEP; for Varispenser® 2/2x, 70 mm – 140 mm, for 2 mL, 5 mL, 10 mL	4966503004
Telescopic aspirating tube , FEP; for Varispenser® 2/2x, 125 mm – 240 mm, for 2 mL, 5 mL, 10 mL	4966504000
Telescopic aspirating tube , FEP; for Varispenser® 2/2x, 195 mm – 350 mm, for 2 mL, 5 mL, 10 mL	4966505007
Telescopic aspirating tube , FEP; for Varispenser® 2/2x, 250 mm – 480 mm, for 2 mL, 5 mL, 10 mL	4966506003
Telescopic aspirating tube , FEP; for Varispenser® 2/2x, 250 mm – 480 mm, for 25 mL, 50 mL, 100 mL	4966508006
Telescopic aspirating tube , FEP; for Varispenser® 2/2x, 170 mm – 330 mm, for 25 mL, 50 mL, 100 mL	4966507000
Bottle thread adapter , PP, from GL 32 to GL 25	4960800040
Bottle thread adapter , PP, from GL 32 to GL 27	4960800139
Bottle thread adapter , PP, from GL 32 to GL/S 28	4960800058
Bottle thread adapter , PP, from GL 45 to GL 32	4960800120
Bottle thread adapter , PP, from GL 45 to GL 38	4960800155
Bottle thread adapter , PP, from GL 45 to S 40	4960800147
Bottle thread adapter , ETFE, from GL 32 to GL 25	4966614000
Bottle thread adapter , ETFE, from GL 32 to GL/S 28	4960835005
Bottle thread adapter , ETFE, from GL 45 to GL 32	4966615007
Bottle thread adapter , ETFE, from GL 45 to GL 38	4960839000
Bottle thread adapter , PTFE, from GL 45 to S 40	4960834009
Thread adapter , for jerrycan 5 L, ETFE, from 45 mm to 17/8" thread	4960832006





Easypet® 3



Experience total control with the Easypet 3

Looking to simplify your manual liquid handling tasks in cell culture and other applications? The Easypet 3 electronic pipette controller from Eppendorf gives you precision and complete speed control, making it ideal for serial dispensing and resuspending bacterial or cell pellets. Easypet 3 can be used with all types of serological and volumetric pipettes from volumes of 0.1 – 100 mL.

Product features

- > Electronic pipette controller designed for use with serological and volumetric pipettes
- > Intuitive and convenient speed adjustment simply done with the tips of your fingers
- > Lightweight, well-balanced and ergonomic design that allows for fatigue-free pipetting

Applications

- > Liquid handling with serological and volumetric pipettes from 0.1 – 100 mL
- > Serial dispensing of aliquots of different volumes
- > Resuspension of bacteria or cell pellets
- > Aspiration of cell layer from e.g. Ficoll® gradient

Technical specifications

Model	Easypet® 3
Weight	160 g
Rechargeable battery	
Capacity	1,100 mAh/3.7 V
Charging time	~3 h
Type	Lithium polymer
Channel type	1-channel
Number of dispensings	~2,000 (with a 25 mL pipette)
Operation	Electronic
Pipetting type	Air cushion system
Mains/power supply	
Input	100 V – 240 V AC ± 10 %, 50 Hz – 60 Hz, 0.5 A
Output	5 V DC, 1.0 A

Ordering information

Description	Order no.
Easypet® 3 , 1-channel, incl. mains/power supply device, wall mounting device, shelf stand, 2 membrane filters 0.45 µm, 0.1 – 100 mL	4430000018
Membrane filter , for Easypet® 3, 0.2 µm, sterile, 5 pcs.	4430606005
Membrane filter , for Easypet® 3, 0.45 µm, sterile, 5 pcs.	4421601009
Lithium polymer rechargeable battery , for Easypet® 3	4430605009



Pipet Helper®



The mechanical pipette aid that allows inexperienced users to work like experts!

Make liquid handling tasks easier than ever with the Pipet Helper mechanical pipette aid from Eppendorf. Streamline lab applications such as assay preparation, petrochemical sample transfer, and preparing buffers for chromatography and fluids for fermentation. Ensuring high-precision manual aspiration and dispensing of liquids, the Pipet Helper is perfect also for less experienced users.

Product features

- > Lightweight mechanical pipette controller with reduced operating force
- > Easy maintenance and cleaning due to easy disassembly, few parts and fully autoclavable
- > Comfortable working because of the good balance and pleasing material

Ordering information

Description	Order no.
Pipet Helper®, 1-channel, 0.1 – 100 mL	4423000010
Membrane filter, for Pipet Helper®, 3 µm, non-sterile, 10 pieces	4423601014

Eppendorf Serological Pipets









Designed to work in perfect harmony with your Easypet® 3 or Pipet Helper®

Eppendorf Serological Pipets are single-use serological pipettes made of ultraclear plastic. They are designed to aspirate and dispense liquids using mechanical or electronic pipette controllers such as the Pipet Helper or Easypet 3.

Product features

- > Clear and precise graduations for easy volume determination
- > Color-coding for easy identification of pipet sizes
- > Subunits with dispenser option to keep stored products safe

Ordering information

Description	Color code	Volume	Order no.
Eppendorf Serological Pipets			
sterile, pyrogen-, DNase-, RNase-, human and bacterial DNA-free. Non-cytotoxic, 800 pcs. (4 × 200 pcs.), individually blister-wrapped	yellow 	1 mL	0030127692
sterile, pyrogen-, DNase-, RNase-, human and bacterial DNA-free. Non-cytotoxic, 600 pcs. (4 × 150 pcs.), individually blister-wrapped	green 	2 mL	0030127706
sterile, pyrogen-, DNase-, RNase-, human and bacterial DNA-free. Non-cytotoxic, 400 pcs. (4 × 100 pcs.), individually blister-wrapped	blue 	5 mL	0030127714
sterile, pyrogen-, DNase-, RNase-, human and bacterial DNA-free. Non-cytotoxic, 400 pcs. (4 × 100 pcs.), individually blister-wrapped	orange 	10 mL	0030127722
sterile, pyrogen-, DNase-, RNase-, human and bacterial DNA-free. Non-cytotoxic, 200 pcs. (4 × 50 pcs.), individually blister-wrapped	red 	25 mL	0030127730
sterile, pyrogen-, DNase-, RNase-, human and bacterial DNA-free. Non-cytotoxic, 160 pcs. (4 × 40 pcs.), individually blister-wrapped	violet 	50 mL	0030127749



Automated Pipetting



We do not want you to work like a robot, so simply let our epMotion devices do the work for you. Automation liberates you by allowing you to concentrate on tasks that require not only your hands but first and foremost your brain.

The epMotion® line of automated liquid handling systems from Eppendorf offer pipetting solutions for low, medium, and high-throughput workflows that can dramatically increase the consistency of your liquid handling tasks.

At Eppendorf, we also provide a wide range of consumables and accessories to extend the versatility and scalability of our epMotion workstations, ensuring that our automated liquid handling systems meet the specific needs of your laboratory.

Automated pipetting workstations

The epMotion family of liquid handling workstations allows you to easily automate reagent kits and standardized protocols which can be tedious, time-consuming, or error-prone when performed manually. In addition, automating your workflow can minimize the exposure to potentially infectious/hazardous agents, free up time for other tasks, increase your reproducibility, standardize your processes and increase your throughput.

Molecular biology methods and genomic workflows are our application focus. We offer easy-to-use, but powerful automated solutions for PCR and qPCR, nucleic acid purification, and Next Generation Sequencing (NGS) library preparation.

Why lab automation?



www.eppendorf.link/choose-a-robot

Automate your workflow!



www.eppendorf.link/epmotionmethods/

Get all information about the Eppendorf automation portfolio!

Explore the eshop and get an overview!

www.eppendorf.link/automation-portfolio



Automated pipetting consumables & accessories

Ensure your workflow is as efficient as possible with our epT.I.P.S.[®] Motion range of pipetting supplies, designed for use with epMotion workstations. All our liquid handling consumables are available in a range of purity grades and are manufactured under strict compliance with ISO regulations.

Optimize your liquid handling workflow with accessories designed for use with epMotion workstations. These accessories extend the functions of our liquid handling robots and enable you to automate more of your protocol for consistent sample processing.



Our Portfolio – Your Choice



Model	epMotion® 96/epMotion® 96xl with 2-position slider	epMotion® 5070
Page(s)	8	9
Dimensions (W × D × H)	22.9 × 45.7 × 53.3 cm / 9 × 18 × 21 in/ 22.9 × 45.7 × 57.6 cm / 9 × 18 × 23 in	65 × 48 × 63 cm / 26 × 19 × 25 in
Weight w/o accessories	19 kg / 42 lb/ 20 kg / 44 lb	45 kg / 99.2 lb
Max. power consumption	175 W	200 W
Power supply	100 – 240 V, 50 – 60 Hz	100 – 240 V, 50 – 60 Hz
Optical confocal infrared detector	Mechanical sensor for tip size verification	Contact-free recognition of fill level, inserted tools, labware, tip types and quantities
SLAS/ANSI positions	1/2	4
Volume range	0.5 – 300 µL/ 5 – 1,000 µL	0.2 µL – 1 mL
Gripper option	no	no
Thermal module		
Thermal module available?	no	no
Cooling rate	–	–
Heating rate	–	–
ThermoMixer upgrade option	no	no
Eppendorf ThermoMixer®		
Speed	–	–
Temperature range	–	–
Vacuum separation option	no	no
Automatic tool exchange	–	2 tools
UV/clean air option	no	no



**epMotion® 5073t/epMotion® 5073t****10**68 × 62 × 81 cm /
27 × 25 × 32 in86 kg / 190 lb/
93 kg / 205 lb

400 W

100 – 240 V, 50 – 60 Hz

Contact-free recognition of fill level, inserted tools, labware, tip types and quantities

6

0.2 µL – 1 mL

yes

max. 1/no

4 °C/min/–

9 °C/min/–

no/included

–/

300 – 2,000 rpm

–/

15 °C below RT to 95 °C

no

3 tools and gripper

yes

epMotion® 5075t/epMotion® 5075t/epMotion® 5075v/epMotion® 5075vt**11**108 × 62 × 81 cm /
43 × 25 × 32 in122 kg / 269 lb/
124 kg / 273 lb /
123 kg / 271 lb/
128 kg / 282 lb

700 W

100 – 240 V, 50 – 60 Hz

Contact-free recognition of fill level, inserted tools, labware, tip types and quantities

15 /14.5 / 12 /12

0.2 µL – 1 mL

yes/yes / included/included

max. 3/max. 2 / max. 3/max. 2

4 °C/min

9 °C/min

yes/included / yes/included

–/

300 – 2,000 rpm /

–/

300 – 2,000 rpm

–/

15 °C below RT to 95 °C /

–/

15 °C below RT to 95 °C

yes/yes / included/included

4 tools and gripper

yes



epMotion 5075t NGS Solution

The epMotion 5075t NGS Solution includes all dispensing tools, accessories, and consumables needed for NGS library preparation of up to 96 samples. It automates the process, providing reproducible and precise results while increasing lab productivity. With maximum kit flexibility, it's ideal for medium- to high-throughput and complex NGS workflows, eliminating the need for labor-intensive manual handling.

Easily operate liquid handling tasks via the MultiCon Desktop PC. The intuitive software interface allows for fast and flexible method implementation and an integrated Eppendorf ThermoMixer® allows for upstream nucleic acid purification. Save valuable time for other laboratory tasks and data analysis.



Product features

- > Includes integrated Eppendorf ThermoMixer®, thermal module and all the tools, accessories and consumables needed for NGS library preparation
- > 14.5 SLAS/ANSI deck positions and automatic tool exchange for 4 tools and gripper
- > Volume range from 0.2 to 1,000 µL (depending on dispensing tools used)

Applications

- > DNA and RNA purification
- > NGS library preparation (medium to high sample numbers)
- > Solid phase extraction
- > PCR/qPCR set-up
- > Tube to plate transfer
- > Plate reformatting
- > Serial dilutions
- > Cherry picking and normalization
- > Sample and reagent transfers
- > Sample mixing and tempering



Unleash Your Potential!



www.eppendorf.link/unleash-your-potential

Handling beads in NGS.



www.eppendorf.link/stay-informed-beads

The ordering information for this product can be found on the [page 11](#)





epMotion® 96 and 96xl



Description

The Eppendorf epMotion 96 is a semi-automated, 96-well multi-channel pipette for fast and precise parallel microplate processing. It is an easy to use bench top liquid handling robot for high precision pipetting in 96 and 384 well plates. Without changes to the system, a large volume range of 0.5 µL to 300 µL is available for convenient use over a range of applications. Its ergonomic design and intuitive handling makes the epMotion 96 a great tool for anyone in the lab who needs fast and precise liquid handling in 96 format.

Product features

- > 0.5 to 300 µL or 5 to 1,000 µL with one system
- > Electronic pipetting with synchronous 96 channel piston movement for better precision and reproducibility of results
- > Auto-detect function for tip size

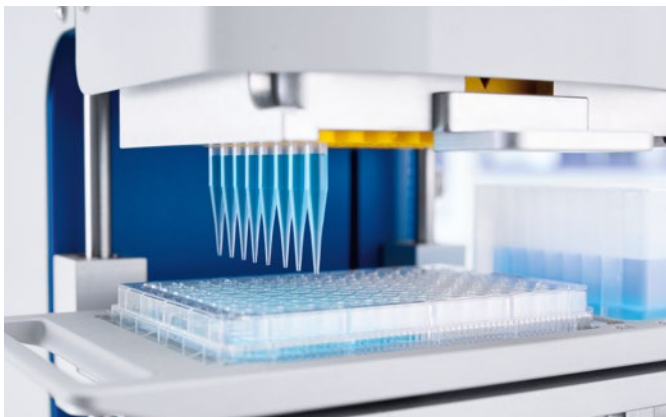

epMotion 96 in motion!



www.eppendorf.link/epM96-in-motion

Ordering information

Description

epMotion® 96, 96-channel, semi-automated electronic pipette for parallel 96 channel microplate processing, 100 – 240 V ±10 %/50 – 60 Hz ±5 % (GB), 0.5 – 300 µL

epMotion® 96 with 2-position slider, 96-channel, with 2-position slider, semi-automated electronic pipette for parallel 96 channel microplate processing, 100 – 240 V ±10 %/50 – 60 Hz ±5 % (GB), 0.5 – 300 µL

epMotion® 96xl, 96-channel, semi-automated electronic pipette for parallel 96 channel microplate processing, 100 – 240 V ±10 %/50 – 60 Hz ±5 % (GB), 5 – 1,000 µL

epMotion® 96xl with 2-position slider, 96-channel, semi-automated electronic pipette for parallel 96 channel microplate processing, 100 – 240 V ±10 %/50 – 60 Hz ±5 % (GB), 5 – 1,000 µL

Order no.

[506900020](#)

[506900128](#)

[506900225](#)

[506900322](#)

✂ Ordering information for other voltage options can be found in the “Voltage Version” chapter.



epMotion® 5070



epMotion 5070 family overview:

epMotion® 5070

The epMotion 5070 is our most compact solution for accurate and reproducible automated pipetting. With four worktable positions and a small footprint the epMotion 5070 is a perfect match for any routine application such as serial dilutions, reagent distribution, sample transfer from tubes to plates, and sample normalization.

epMotion® 5070 PCR Solution

The epMotion 5070 PCR Solution is a complete automation solution for your PCR and qPCR setup, designed to fit into minimal space. It features automated liquid handling and software with advanced features, as well as all the necessary accessories to streamline your PCR workflows.

Product features

- > 4-position worktable
- > Volume range from 0.2 to 1,000 µL (depending on dispensing tools used)
- > Automatic tool exchange for 2 tools

Applications

- > PCR/qPCR set-up
- > Tube to plate transfer
- > Plate reformatting
- > Serial dilutions
- > Cherry picking and normalization
- > Sample and reagent transfers

epMotion 5070
for PCR



[www.eppendorf.link/
increase-flexibility](http://www.eppendorf.link/increase-flexibility)

Ordering information

Description	Order no.
epMotion® 5070 MultiCon, completely contained housing, system incl. MultiCon, epBlue software, keyboard, mouse, waste box, 100 – 240 V/50 – 60 Hz, 0.2 µL – 1 mL, (depending on dispensing tools)	5070000282
epMotion® 5070 MultiCon PCR Solution, includes MultiCon PC, dispensing tool (TS 50), PCR specific accessories, 100 – 240 V/50 – 60 Hz, 0.2 µL – 1 mL, (depending on dispensing tools)	5070000948





epMotion® 5073

New



epMotion 5073 family overview:

epMotion® 5073I

Why spend valuable time on challenging liquid handling procedures when you can achieve fast, accurate and reproducible results with the epMotion 5073I automated liquid handler? Perfect for medium-throughput setup for PCR and qPCR, DNA/RNA normalization, cherry picking, dilution series and reformatting, the epMotion 5073I helps you perform pipetting tasks with ease and greater efficiency.

epMotion® 5073t

The epMotion 5073t automated liquid handling system allows you to perform fast and efficient NGS library preparation of 1 to 24 samples. It is also ideal for automating more complex, time-consuming liquid handling tasks such as DNA/RNA extraction. Save time and improve the reproducibility of your results with the epMotion 5073t!

Also available as **epMotion® 5073t NGS Solution** including all the accessories and high-quality consumables needed for reliable low-to-medium-throughput NGS library preparation.

Product features

- > 6-position worktable
- > Volume range from 0.2 to 1,000 µL (depending on dispensing tools used)
- > Automatic tool exchange for 3 tools

Applications

- > DNA and RNA purification
- > NGS library preparation (small sample numbers)
- > PCR/qPCR setup
- > Tube to plate transfer
- > Plate reformatting
- > Serial dilutions
- > Cherry picking and normalization
- > Sample and reagent transfers
- > Sample mixing and tempering

Ordering information

Description	Order no.
epMotion® 5073I, MultiCon PC, completely contained housing, epBlue software, keyboard, mouse, system for solid and liquid waste, 100 – 240 V/50 – 60 Hz, 0.2 µL – 1 mL, (depending on dispensing tools)	5073000110
epMotion® 5073t, MultiCon PC, completely contained housing, ThermoMixer, epBlue software, keyboard, mouse, system for solid and liquid waste, 100 – 240 V/50 – 60 Hz, 0.2 µL – 1 mL, (depending on dispensing tools)	5073000111
epMotion® 5073t NGS Solution, MultiCon PC, completely contained housing, ThermoMixer, 3 dispensing tools, gripper, NGS specific accessories and consumables, epBlue software with Enhanced Feature Set 1, system for solid and liquid waste, 100 – 240 V/50 – 60 Hz, 0.2 µL – 1 mL, (depending on dispensing tools)	5073000112



epMotion® 5075

New



Product features

- > Up to 15 worktable positions
- > Volume range from 0.2 to 1,000 µL (depending on dispensing tools used)
- > Automatic tool exchange for 4 tools

Applications

- > DNA and RNA purification
- > NGS library preparation (medium to high sample numbers)
- > Solid phase extraction
- > PCR/qPCR set-up
- > Tube to plate transfer
- > Plate reformatting
- > Serial dilutions
- > Cherry picking and normalization
- > Sample and reagent transfers
- > Sample mixing and tempering

epMotion 5075 family overview:

epMotion® 5075I

Don't stress yourself by doing complex pipetting tasks when you can perform fast, accurate and reproducible PCR plate setup with the epMotion 5075I automated liquid handler. The epMotion 5075I offers 15 worktable positions and is well suited for high-throughput preparation of plates, PCR or qPCR setup, DNA/RNA normalization, cherry picking, dilution series, reformatting, and immunoassays. Say goodbye to tedious pipetting steps!

epMotion® 5075t

The epMotion 5075t automated liquid handling system allows you to perform high-throughput NGS library preparation with magnetic beads with speed and efficiency. It is also ideal for automating more complex, time-consuming liquid handling tasks such as DNA/RNA extraction and ELISA. Save time and improve the reproducibility of your results with the epMotion 5075t!

Also available as **epMotion® 5075t NGS Solution** including all the accessories and high-quality consumables needed for reliable medium-to-high-throughput NGS library preparation.

epMotion® 5075v

With integrated vacuum filtration, the epMotion 5075v allows true walk-away automation of filter-based purification or extraction protocols. Increase your lab productivity and free up time for other tasks!

epMotion® 5075vt

With integrated vacuum filtration and a combined mixing and temperature control module in one system, the epMotion 5075vt allows true walk-away automation of both filter- and bead-based, purification or extraction protocols. Do not let complex purifications and extractions tie you to your workbench!

Ordering information

Description	Order no.
epMotion® 5075I, MultiCon PC, completely contained housing, epBlue software, keyboard, mouse, system for solid and liquid waste, 100 – 240 V/50 – 60 Hz, 0.2 µL – 1 mL, (depending on dispensing tools)	5075000041
epMotion® 5075t, MultiCon PC, completely contained housing, ThermoMixer, epBlue software, keyboard, mouse, system for solid and liquid waste, 100 – 240 V/50 – 60 Hz, 0.2 µL – 1 mL, (depending on dispensing tools)	5075000042
epMotion® 5075t NGS Solution, MultiCon PC, completely contained housing, ThermoMixer, thermal module, 4 dispensing tools, gripper, NGS specific accessories and consumables, epBlue software with Enhanced Feature Set 1, system for solid and liquid waste, 100 – 240 V/50 – 60 Hz, 0.2 µL – 1 mL, (depending on dispensing tools)	5075000045
epMotion® 5075v, MultiCon PC, completely contained housing, vacuum system with accessories, gripper, epBlue software, keyboard, mouse, system for solid and liquid waste, 100 – 240 V/50 – 60 Hz, 0.2 µL – 1 mL, (depending on dispensing tools)	5075000043
epMotion® 5075vt, MultiCon PC, completely contained housing, vacuum system with accessories, gripper, ThermoMixer, epBlue software, keyboard, mouse, system for solid and liquid waste, 100 – 240 V/50 – 60 Hz, 0.2 µL – 1 mL, (depending on dispensing tools)	5075000044





epT.I.P.S.[®] Motion as Reload System



Description

Eppendorf Totally Integrated Pipetting System for Automation

The epT.I.P.S. Motion have been developed to work in perfect combination with our epMotion platform. In combination with a TipHolder accessory the Reload trays offer a more environmentally friendly option.

Ordering information

Description	Order no.
epT.I.P.S.[®] Motion as Reload System, without filter	
Eppendorf Quality, 10 µL, 2,304 tips (24 trays × 96 tips)	0030014545
Eppendorf Quality, 50 µL, 2,304 tips (24 trays × 96 tips)	0030014421
Eppendorf Quality, 300 µL, 2,304 tips (24 trays × 96 tips)	0030014464
Eppendorf Quality, 1,000 µL, 2,304 tips (24 trays × 96 tips)	0030014502
epT.I.P.S.[®] Motion as Reload System, with filter	
PCR clean, 10 µL, 2,304 tips (24 trays × 96 tips)	0030014553
PCR clean, 50 µL, 2,304 tips (24 trays × 96 tips)	0030014430
PCR clean, 300 µL, 2,304 tips (24 trays × 96 tips)	0030014472
PCR clean, 1,000 µL, 2,304 tips (24 trays × 96 tips)	0030014510
PCR clean and sterile, 10 µL, 2,304 tips (24 trays × 96 tips)	0030014561
PCR clean and sterile, 50 µL, 2,304 tips (24 trays × 96 tips)	0030014529
PCR clean and sterile, 300 µL, 2,304 tips (24 trays × 96 tips)	0030014537
PCR clean and sterile, 1,000 µL, 2,304 tips (24 trays × 96 tips)	0030014570
TipHolder, for epT.I.P.S.[®] Motion Reloads	5075751399
Clip for epT.I.P.S.[®] Motion Reloads	5075751070
Box for epT.I.P.S.[®] Motion 1,000 µL Reload	0030014677
Box for epT.I.P.S.[®] Motion 10/50/300 µL Reload	0030014669

epT.I.P.S.[®] Motion Pipette Tips



Description

Eppendorf Totally Integrated Pipetting System for Automation

For routine pipetting with excellent precision it is important to have a perfect system of tips and automate. The epT.I.P.S. Motion have been developed to work in perfect combination with our epMotion platform.

Ordering information

Description	Order no.
epT.I.P.S.[®] Motion Pipette Tips, without filter	
sterile, 10 µL, 960 tips (10 racks × 96 tips)	0030015185
sterile, 50 µL, 960 tips (10 racks × 96 tips)	0030015207
sterile, 300 µL, 960 tips (10 racks × 96 tips)	0030015223
sterile, 1,000 µL, 960 tips (10 racks × 96 tips)	0030015240
Eppendorf Quality, 10 µL, 960 tips (10 racks × 96 tips)	0030014383
Eppendorf Quality, 50 µL, 960 tips (10 racks × 96 tips)	0030014405
Eppendorf Quality, 300 µL, 960 tips (10 racks × 96 tips)	0030014448
Eppendorf Quality, 1,000 µL, 960 tips (10 racks × 96 tips)	0030014480
epT.I.P.S.[®] Motion Pipette Tips, with filter	
PCR clean and sterile, 10 µL, 960 tips (10 racks × 96 tips)	0030015193
PCR clean and sterile, 50 µL, 960 tips (10 racks × 96 tips)	0030015215
PCR clean and sterile, 300 µL, 960 tips (10 racks × 96 tips)	0030015231
PCR clean and sterile, 1,000 µL, 960 tips (10 racks × 96 tips)	0030015258
PCR clean, 10 µL, 960 tips (10 racks × 96 tips)	0030014391
PCR clean, 50 µL, 960 tips (10 racks × 96 tips)	0030014413
PCR clean, 300 µL, 960 tips (10 racks × 96 tips)	0030014456
PCR clean, 1,000 µL, 960 tips (10 racks × 96 tips)	0030014499
epT.I.P.S.[®] Motion as SafeRack tips, without filter	
Eppendorf Quality, 50 µL, 960 tips (10 racks × 96 tips)	0030014600
Eppendorf Quality, 300 µL, 960 tips (10 racks × 96 tips)	0030014626
Eppendorf Quality, 1,000 µL, 960 tips (10 racks × 96 tips)	0030014642
epT.I.P.S.[®] Motion as SafeRack tips, with filter	
PCR clean, 50 µL, 960 tips (10 racks × 96 tips)	0030014618
PCR clean, 300 µL, 960 tips (10 racks × 96 tips)	0030014634
PCR clean, 1,000 µL, 960 tips (10 racks × 96 tips)	0030014650



Dispensing Tools



Description

The dispensing tools for the epMotion liquid handling workstations are precision instruments for pipetting and dispensing of a variety of different liquids. They are available as single channel as well as multichannel tools, and they cover the volume range between 0.2 and 1,000 μL .

Product features

- > Highest accuracy from 200 nL to 1,000 μL
- > For various types of liquids
- > 1- and 8-channel dispensing tools

Ordering information

Description	Order no.
Holder for 6 dispensing tools	5075774003
Gripper , incl. holder, for transporting plates on the worktable and automatic operation of the vacuum manifold, additionally order Gripper Tower 5075751895 for 5073 with SN > 6000	5282000018
TS 10 single channel dispensing tool , 1-channel, 0.2 – 10 μL	5280000100
TS 50 single-channel dispensing tool , 1-channel, 1.0 – 50 μL	5280000010
TS 300 single-channel dispensing tool , 1-channel, 20 – 300 μL	5280000037
TS 1000 single-channel dispensing tool , 1-channel, 40 – 1,000 μL	5280000053
TM 10-8 eight-channel dispensing tool , 8-channel, 0.2 – 10 μL	5280000304
TM 50-8 eight-channel dispensing tool , 8-channel, 1.0 – 50 μL	5280000215
TM 300-8 eight-channel dispensing tool , 8-channel, 20 – 300 μL	5280000231
TM 1000-8 eight-channel dispensing tool , 8-channel, 40 – 1,000 μL	5280000258
Holder for gripper	5075759004

Pipetting performance specifications measured based on ISO 8655-6

Single-channel tool	Volume range	Volume	Rel. systematic error	Rel. random error
TS 10	0.2 – 10 μL	0.2 μL	$\pm 25\%$	$\pm 19.8\%$
		1 μL	$\pm 5\%$	$\pm 3\%$
		5 μL	$\pm 2.4\%$	$\pm 0.5\%$
		10 μL	$\pm 1.2\%$	$\pm 0.25\%$
TS 50	1.0 – 50 μL	1 μL	$\pm 15\%$	$\pm 5.0\%$
		5 μL	$\pm 5.0\%$	$\pm 3.0\%$
		25 μL	$\pm 1.5\%$	$\pm 0.6\%$
		50 μL	$\pm 1.0\%$	$\pm 0.4\%$
TS 300	20 – 300 μL	20 μL	$\pm 4.0\%$	$\pm 2.5\%$
		30 μL	$\pm 3.0\%$	$\pm 1.5\%$
		150 μL	$\pm 1.0\%$	$\pm 0.4\%$
		300 μL	$\pm 0.6\%$	$\pm 0.3\%$
TS 1000	40 – 1,000 μL	40 μL	$\pm 5.0\%$	$\pm 1.5\%$
		100 μL	$\pm 2.0\%$	$\pm 1.0\%$
		500 μL	$\pm 1.0\%$	$\pm 0.2\%$
		1,000 μL	$\pm 0.7\%$	$\pm 0.15\%$

For more information on pipetting performance,
please read the application notes



For the 50, 300 and
1000 μL tools

[www.eppendorf.link/
epMotion-Artel](http://www.eppendorf.link/epMotion-Artel)



For the 10 μL tools

[www.eppendorf.link/
epMotion-Artel-10ul](http://www.eppendorf.link/epMotion-Artel-10ul)





epMotion® 96 Accessories



Description

The accessories for the epMotion 96 and epMotion 96xl increase the capacity for plates and reservoirs. Optional tip trays and adapter allow 384 well plates to be handled with ease.

Ordering information

Description	Order no.
Loading frame for epMotion® 96	5069072005
Adapter 384-well plate for epMotion® 96	5069073001
O-ring tool set, with separator, blade, hook, mounting cone, mounting cylinder	5069858505
O-ring black, 100 pcs.	5069867504
Modification kit for 2-position slider (4.5 mm increments), including constant-force spring, shielding plates (epMotion 96 and 96xl), screws, guiding aid and holding devices (epMotion 96 as of serial number 2008, all epMotion 96xl)	5069878506

Device Hardware Upgrades

Ordering information

Description	Order no.
New Thermal Module Upgrade Set , retrofitting of one thermal module for heating and cooling (0 – 110 °C) of thermoadapters, thermoblocks and thermoracks	5075757508
New CleanCap Upgrade Set for epMotion® 5075, includes UV lamp and air filter system for decontamination and pipetting under clean air conditions, for upgrading epMotion 5075 with SN>10,000 and epBlue version >50.0	5075001888
Device Hardware Upgrades and Software, Upgrade set to MultiCon, changes existing epMotion EasyCon to PC controller. Includes PC, keyboard, mouse, epBlue SW, PCR & Prep assistant, cables	5075000725
CleanCap Upgrade Set for epMotion® 5073, includes UV lamp and air filter system for decontamination and pipetting under clean air conditions, for upgrading epMotion 5073 with SN>7000 and epBlue version >40.7	5073001333

These products require a service visit for installation

Power Supply Cables

Ordering information

Description	Order no.
Mains/power cord	
230 V/50 Hz (EU)	0013563934
230 V/50 Hz (GB/Hong-Kong)	0013594490
230 V/50 Hz (AR)	0013613973
230 V/50 Hz (CN)	0013613952
230 V/50 Hz (AU)	0013592454
120 V/50 Hz (US)	0013563942



Software

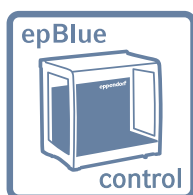

epBlue epMotion® PC software

- > Graphical user interface
- > Main menu with direct access to the most important functions
- > 3D view of workstation and run simulation



epBlue ID software

- > Visual tracking of the scan procedure
- > Automatic checking of the worktable
- > Scanning of individual reaction vessels and microplates

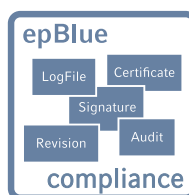

epBlue GxP software

- > Complete electronic documentation
- > Access control and user level management
- > Audit trail and log file



www.eppendorf.link/epBlue

Ordering information

Description

epBlue ID barcode and tracking software incl. manual barcode scanner, modular expansion of epBlue for barcode support. Incl. manual barcode reader with stand. Compatible with epBlue version 40.1 and higher

Order no.

[5075002701](#)

New

Enhanced Feature Set GxP, licence for epBlue feature: GxP, for support of regulated environments (e.g. according to GLP, GMP, 21 CFR Part 11), requires service visit and epBlue 40.9 or higher

[5075002744](#)

Enhanced Feature Set 1, license for epBlue additional features: Calculated no. of samples; Automatic tool selection; Start at command; Email notification, requires service visit and epBlue >40.6

[5075000964](#)

Enhanced Feature Set 2, license for epBlue feature: Normalization, requires Service visit and epBlue 40.8 or higher

[5075000981](#)



Your local distributor: www.eppendorf.link/contact

Eppendorf UK Limited · Gateway 1000 · Whittle Way · Stevenage SG1 2FP · United Kingdom · sales@eppendorf.co.uk · www.eppendorf.com · www.eppendorf.link/eshop



epMotion® ReservoirRacks and Modules



Description

The Eppendorf Reservoirs are the perfect vessels for a 10 to 400 mL liquid range, and permit the use of single channel and multichannel dispensing tools. The tapered shape of the reservoirs allows utilization of the entire liquid volume with minimal residue. Moreover, the reservoirs may be temperature-controlled inside the racks to allow cooling or warming of liquids.

Our Reservoir Racks hold reaction vessels of different sizes, and allow tempering in order to protect valuable samples or carry out reactions directly inside the Reservoir Rack.

Ordering information

Description	Order no.
ReservoirRack , for presenting 10 mL, 30 mL and 100 mL reagent reservoirs. Up to 7 reservoirs or Reservoir Rack modules can be presented.	5075754002
Adapter sleeves , to retrofit the 1.5/2.0 mL thermoracks for use with 0.5 mL vessels, 25 pcs.	5075772000
Gripper Tower , enables positioning epT.I.P.S.® Motion Reload trays in the parking position of the gripper and holds the gripper when it is not in use; only for use with epMotion® 5073 as of serial number 6000	5075751895
Tip Tool , tool for exclusively transferring epT.I.P.S.® Motion from racks and trays to the ReservoirRack modules for tips, incl. wall mount for safe storage of the tool	5285000000
Reservoir Rack Module NGS , for use with epMotion® ReservoirRacks, for distributing samples and reagents for NGS-specific applications, space for 20 x ILMN tubes, 4 x Eppendorf Tubes® 5.0 mL, 4 x Eppendorf Tubes 1.5 mL	5075751917
Reservoir Rack Module PCR , for use with epMotion® ReservoirRacks, for distributing samples and reagents for PCR, space for 48 x PCR tubes 0.2 mL incl. 2 x strip adapters 0.2 mL, (alternatively, space sufficient for 16 index tubes and up to 32 x PCR tubes 0.2 mL), 12 x Eppendorf Tubes 1.5/2.0 mL, 1 x tube 5.0 mL	5075751933
Reservoir Rack Module Tips , for use with epMotion® ReservoirRacks, for providing up to 16 epT.I.P.S.® Motion per module and up to 7 modules per ReservoirRack (112 tips in total), set consisting of 7 modules	5075751950
TipHolder , for epT.I.P.S.® Motion Reloads	5075751399
TipHolder 73 , enables positioning epT.I.P.S.® Motion Reload trays above a rack of epT.I.P.S.® Motion and thus doubles the tip capacity in an ANSI/SLAS position, reusable and autoclavable, epBlue 40.7 or higher required	5075751879
ReservoirRack Module TC , for use in epMotion® ReservoirRacks, temperable, 8 x PCR tubes 0.2 mL	5075799049
ReservoirRack Module TC , for use in epMotion® ReservoirRacks, temperable, 4 x Safe-Lock tubes 0.5/1.5/2.0 mL	5075799081
ReservoirRack Module TC , for use in epMotion® ReservoirRacks, temperable, 4 x Eppendorf Tubes® 5.0 mL	5075799340
ReservoirRack Module TC , for use in epMotion® ReservoirRacks, temperable, 4 x reaction vessels Ø 12 mm	5075799103
ReservoirRack Module TC , for use in epMotion® ReservoirRacks, temperable, 4 x reaction vessels Ø 16 mm	5075799120
ReservoirRack Module TC , for use in epMotion® ReservoirRacks, temperable, 4 x reaction vessels Ø 17 mm	5075799162
ReservoirRack Module TC , for use in epMotion® ReservoirRacks, temperable, 2 x reaction vessels Ø 29 mm	5075799189
ReservoirRack Module TC , for use in epMotion® ReservoirRacks, temperable, 1 x reservoir 10 mL	5075799421
ReservoirRack Module TC , for use in epMotion® ReservoirRacks, temperable, 1 x reservoir 30 mL	5075799146
ReservoirRack Module TC , for use in epMotion® ReservoirRacks, temperable, 1 x reservoir 100 mL	5075799260
epMotion® reservoir 10 mL , small-volume container for reagent presentation on the epMotion®, can only be inserted with the Reservoir Rack; production batch testing, certified, 10 mL, PCR clean, 10 x 5 reservoirs in the bag, polypropylene (PP)	0030126521
epMotion® reservoir 30 mL , large-volume container for reagent presentation on the epMotion®, can only be inserted with the Reservoir Rack; production batch testing, certified, 30 mL, PCR clean, 10 x 5 reservoirs in the bag, polypropylene (PP)	0030126505
epMotion® reservoir 100 mL , large-volume container for reagent presentation on the epMotion®, can only be inserted with the Reservoir Rack; production batch testing, certified, 100 mL, PCR clean, 10 x 5 reservoirs in the bag, polypropylene (PP)	0030126513
epMotion® reservoir 400 mL , large-volume container for reagent presentation on the epMotion®, 10 reservoirs, 400 mL each, autoclavable, polypropylene (PP)	5075751364
epMotion® reservoir 195 mL , low dead volume reservoir, single well with 96 cavities, PCR clean, 4 x 5 reservoirs, 195 mL, polypropylene (PP)	0030126556



epMotion[®] Thermoracks and Plate Accessories



Description

The Thermoracks, Thermoblocks and Thermodapters comprise versatile options for the cooling or warming of reaction vessels and plates of different formats. The gripper for plates and racks allows automated transport and stacking on the deck. A 96 well magnet adapter for applications using magnetic beads is also available, and it enables fully automated extraction and purification protocols and/or NGS library preparation using a diverse range of kits.

Ordering information

Description	Order no.
Thermorack CB , for holding up to 384 x 0.1 mL strip tubes in the Corbett Research Rotor-Gene 3000	5075767031
Eppendorf Magnum FLX[®] Magnet Adapter , universal ring magnet plate for rapid magnetic bead separation. Supports most 96-well plates (standard, PCR, deepwell)	5075751836
Thermorack Rotor/Tubes , for temperature controlled pipetting of Qiagen [®] Rotor-Disc [®] 72/100 and 20 tubes 1.5/2.0 mL	5075751526
Thermoblock PCR 96 OC , for temperature control and safe piercing of sealed, semi-skirted PCR plates with orientation control	5075751666
Thermodapter for PCR , for temperature control of PCR plates, 96 wells, skirted	5075787008
Thermodapter for PCR , for temperature control of PCR plates, 384 wells, skirted	5075788004
Thermodapter Frosty , combination of height adapter and PCR-Cooler, for cooling skirted PCR plates	5075789000
Thermoblock DWP 2000 , for 2 mL Eppendorf Deepwell Plates 96/2000	5075751330
Thermodapter DWP 96 , for Deepwell Plates 96/1000	5075751054
Thermodapter LC Sample , for MagNA Pure LC sample cartridge	5075751305
Thermorack , for 24 Safe-Lock tubes, temperable, 0.5/1.5/2.0 mL	5075769000
Thermorack , for 24 Safe-Lock tubes, temperable, 1.5/2.0 mL	5075771004
Thermorack TMX , for 24 Safe-Lock micro test tubes, 0.5 mL/1.5 mL/2.0 mL	5075751160
Thermorack TMX , for 24 Safe-Lock tubes, temperable, 1.5/2.0 mL	5075751186
Thermorack , for 24 Cryo tubes	5075777055
Thermoblock for PCR , for temperature control of 96 vessels 0.2 mL or one PCR plate 96 wells	5075766000
Thermoblock for PCR , for temperature control of PCR plate 384 wells	5075767007
Thermodapter for Microplate 96/V/U , for holding and temperature control of Eppendorf Microplates with V or U bottom	5075751577





epMotion® Tube Racks, Adapters and Vacuum Modules

Description

Tube racks are specially designed for the respective dimensions of the reaction vessels, and they thus provide optimal support for plastic as well as glass vessels.



Ordering information

Description	Order no.
PrepRack for 24 Eppendorf Safe-Lock Tubes 2 mL , for nucleic acid preparation	5073751006
Rack for single test tubes , for presenting Eppendorf reaction vessels, glass or plastic tubes, not temperable	
Ø 17 mm × 100 mm max. length	5075761009
Ø 17 mm × 60 mm max. length	5075775000
Ø 16 mm × 100 mm max. length	5075760002
Ø 16 mm × 60 mm max. length	5075776006
Ø 15 mm × 100 mm max. length	5075792028
Ø 15 mm × 60 mm max. length	5075792044
Ø 14 mm × 100 mm max. length	5075792001
Ø 14 mm × 60 mm max. length	5075792060
Ø 13 mm × 100 mm max. length	5075762005
Ø 13 mm × 60 mm max. length	5075792087
Ø 12 mm × 100 mm max. length	5075763001
Ø 12 mm × 60 mm max. length	5075792109
Rack , for 24 HPLC tubes, Ø 12 mm × 40 mm max. length	5075792125
Rack , for 96 screw cap tubes, 1.5/2.0 mL	5075791005
Rack for 24 tubes , for 24 Safe-Lock tubes, no tempering	
0.5/1.5/2.0 mL	5075751453
1.5/2.0 mL	5075751275
Vac holder , adapter for Vac Frame	5075778009
Vacuum lid , lid for vacuum unit	5075779005
Silicone mat for Vac Lid	5075793008
Vac Frame 1 , 16 mm height, recommended for filter plates from 5Prime, Invitex	5075784009
Vac Frame 2 , 26 mm height, recommended for filter plates from MACHERY NAGEL®, Promega® or Qiagen®	5075785005
Anticontamination plate adapter , for vacuum processes with foaming solutions in multiwell plates, set of 10	5075794004
Vac Thermo lid	5075796007
Collection plate adapter MN , type for VAC station	5075785064
Elution plate adapter , for processing micro tubes in racks	5075785030
Rack Smart , for holding one tube rack of SmartCycler® reaction tubes	5075790009
Rack LC 20 µL/100 µL , for up to 96 × 20 µL or 100 µL LightCycler capillaries for use with Centrifuge 5804/5804 R or 5810/5810 R and other devices, set of 2	5075795000
Adapter for Covaris Rack 12 × 8 Strips , for E-series rack 12 place 8 microTUBEStrip V2 from Covaris PN 500444	5075751801
Rack ILMN tubes , Rack for single tubes, 40 × Ø 8.4 mm and 12 × Ø 11.2 mm, transportable, autoclavable	5075751747



epMotion® Waste Disposal Accessories



Description

During the pipetting of liquids, waste, both liquid and solid, is generated. Solid waste mainly consists of pipette tips and reaction vessels. In order to dispose both types of waste correctly, we offer variable options.

Ordering information

	Description	Order no.
New	Liquid Waste System , consisting of splash protection, waste funnel, waste tub, tub lid. For use on epMotion® 5075 and epMotion® 5073 with serial no. > 10,000	5075799448
New	Waste bags bio-hazardous waste , for epMotion 5075 with serial no. > 10,000. Up to 10 L volume, ideal for disposing biologically hazardous waste, autoclavable, PP material, thickness 50 µm, transparent, 50 bags	5075752034
New	Waste bags , for epMotion 5075 with serial no. > 10,000. Up to 10 L volume, ideal for disposing non-biologically hazardous waste, autoclavable, PP material, thickness 50 µm, transparent, 50 bags	5075752050
	Waste bags biohazard , for waste bag holder of epMotion® 5070/5073/5075 with SN < 10000 and epMotion® 5073 with SN > 10000. Up to 7 L capacity, ideal for disposing biohazardous waste, autoclavable, PP material, thickness 50 µm, transparent, 50 bags.	5075751763
	Waste bags , for waste bag holder of epMotion® 5070/5073/5075 with SN < 10000 and epMotion® 5073 with SN > 10000. Up to 7 L capacity, ideal for disposing non-hazardous waste, autoclavable, PP material, thickness 50 µm, transparent, 50 bags.	5075751780

epMotion® Height Adapters



Description

Adjusting the height of vessels is necessary when optimizing protocols and workflows. Our various height adapters enable users to level lab ware on the worktable for faster sample processing.

Ordering information

Description	Order no.
epMotion® height adapter , for leveling labware, enables faster plate processing	
85 mm	5075751003
55 mm	5075752000
40 mm, for pipette tips	5075755009



Temperature Control and Mixing



Every lab needs to heat, cool, and mix samples. Nucleic acid or protein purification and analysis, cell and tissue research or expression profiling – all of these applications require a thermal mixer.

An accurate temperature might be the first thing that comes to your mind when thinking about a thermal mixer. For us, temperature accuracy is a must, and we test each SmartBlock separately after production to certify its performance.

The mixing performance is guaranteed by our proven ^{2D} Mix-Control, ensuring even small volumes are mixed efficiently. If you are only looking for efficient mixing without temperature control, the MixMate® is your 3-in-1 choice – a Vortex, plate, and tube mixer all in one package.

Additionally, your thermal mixer must be reliable, robust, easy-to-handle, and versatile. We enhance your vessel flexibility with 15 different Eppendorf SmartBlock thermoblocks – from 0.1 mL tubes or plates up to 50 mL Eppendorf Conical Tubes. Each SmartBlock can be easily attached with only one hand to the Eppendorf ThermoMixer® C, or Eppendorf ThermoStat C, and is individually certified for temperature accuracy. If you need enhanced capacity and a second incubation temperature for 1.5 mL tubes, we offer the SmartExtender – perform your heat-shock transformation in one device.



Get all information about the Eppendorf mixer portfolio!
Explore the eshop and get an overview!
www.eppendorf.link/mixer-portfolio



Temperature Control and Mixing

When working with cell lines, our Eppendorf SmartBlock cryo thaw offers a special program for smooth thawing of cell culture vials, and reagents: convenient, capable of handling multiple vials at once, reduced contamination, and reproducible.

Your samples can be protected from evaporation and condensation at the tube lid when using the ThermoTop®, which heats the sample from above. Your reaction happens where you want it – down in the tube.

Easy programming is a necessity. To increase your efficiency, each device has preprogrammed keys with the ideal parameters for efficient mixing of vessels, like a PCR plate, as well as preprogrammed temperature keys, like 37 °C or 95 °C.

We care about you and your safety, so we designed all of our devices with an isolating layer on the block that protects you from burning your fingers. All surfaces are smooth without edges and easy to clean and disinfect.



Use the Eppendorf ThermoMixer® C for heating, cooling and mixing of your samples. Multiple Eppendorf SmartBlocks enlarge your vessel flexibility from 384-well plates to 50 mL tubes.

Versatility of ThermoMixer

www.eppendorf.link/mixer-versatility

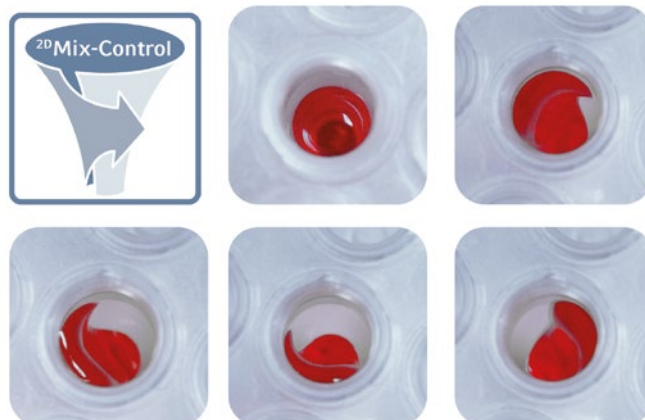

The 2^D Mix-Control ensures efficient mixing of even small volumes by a broad orbital movement.



Download the mixer brochure for detailed information

www.eppendorf.link/mixer-brochure

Our Portfolio – Your Choice



Model	Eppendorf ThermoMixer® C	Eppendorf ThermoStat C	Eppendorf ThermoMixer® F0.5
Page(s)	6	7	8
Timer	5 sec to 99:30 h, continuous	5 s to 99:30 h, continuous	–
Mixing and vortexing radius	1.5 mm	–	1.5 mm
Mixing orbit	3 mm	–	3 mm
Mixing frequency	300 – 3,000 rpm ¹⁾	–	300 – 2,000 rpm
Max. speed	3,000 rpm ¹⁾	–	2,000 rpm
Temperature settings	1 °C / 100 °C	-10 °C/110 °C (110 °C when using the SmartBlocks 12 mm or cryo)	1 °C / 100 °C
Temperature range	Min: 15 °C ¹⁾ below RT, max: 100 °C	Min: 30 °C ¹⁾ below RT, max: 110 °C (110 °C when using the 12 mm and cryo SmartBlocks)	Min: 4 °C above RT, max: 100 °C
Temperature accuracy	Max. ±0.5 °C at 20 – 45 °C	Max. ±0.5 °C at 20 – 45 °C ¹⁾	Max. ±0.5 °C at 20 – 45 °C
Interfaces	USB interface	USB interface	USB interface
Dimensions (W × D × H)	20.6 × 30.4 × 13.6 cm / 8.1 × 12.0 × 5.4 in	20.6 × 30.4 × 13.6 cm / 8.1 × 11.9 × 5.3 in	20.6 × 30.4 × 16.3 cm / 8.1 × 1.9 × 6.4 in
Weight w/o accessories	6.3 kg / 13.9 lb	4.3 kg / 9.7 lb	6.2 kg / 13.6 lb
Power supply	100 – 130 V/220 – 240 V, 50 – 60 Hz	100 – 130 V/220 – 240 V, 50 – 60 Hz	100 – 130 V/220 – 240 V, 50 – 60 Hz
Max. power consumption	200 W	200 W	200 W
Application	> Heating > Cooling > Mixing > all SmartBlocks can be adapted	> Heating > Cooling > all SmartBlocks can be adapted	> Heating > Mixing > only suitable for 0.5 mL tubes

¹⁾ depending on SmartBlock used

Get all information about the Eppendorf mixer portfolio!
Explore the eshop and get an overview!

www.eppendorf.link/mixer-portfolio



Temperature Control and Mixing



Eppendorf ThermoMixer® F1.5	Eppendorf ThermoMixer® F2.0	Eppendorf ThermoMixer® FP	MixMate®
8	8	8	9
–	–	–	15 s – 99.3 h, continuous
1.5 mm	1.5 mm	1.5 mm	1.5 mm
3 mm	3 mm	3 mm	3 mm
300 – 1,500 rpm	300 – 1,500 rpm	300 – 2,000 rpm	300 – 3,000 rpm
1,500 rpm	1,500 rpm	2,000 rpm	3,000 rpm
1 °C / 100 °C	1 °C / 100 °C	1 °C / 100 °C	–
Min: 4 °C above RT, max: 100 °C	Min: 4 °C above RT, max: 100 °C	Min: 4 °C above RT, max: 100 °C	–
Max. ±0.5 °C at 20 – 45 °C	Max. ±0.5 °C at 20 – 45 °C	Max. ±0.5 °C at 20 – 45 °C	–
USB interface	USB interface	USB interface	–
20.6 × 30.4 × 17.0 cm / 8.1 × 11.9 × 6.7 in	20.6 × 30.4 × 17.0 cm / 8.1 × 11.9 × 6.7 in	20.6 × 30.4 × 16.4 cm / 8.1 × 11.9 × 6.4 in	17.0 × 23.0 × 13.0 cm / 6.7 × 9.1 × 5.1 in
6.3 kg / 13.9 lb	6.3 kg / 13.9 lb	6.1 kg / 13.4 lb	4.2 kg / 9.2 lb
100 – 130 V/220 – 240 V, 50 – 60 Hz	100 – 130 V/220 – 240 V, 50 – 60 Hz	100 – 130 V/220 – 240 V, 50 – 60 Hz	110 – 120 V/220 – 240 V, 50 – 60 Hz
200 W	200 W	200 W	40 W
> Heating	> Heating	> Heating	> Mixing
> Mixing	> Mixing	> Mixing	> Vortexing
> only suitable for 1.5 mL tubes	> only suitable for 2 mL tubes	> only suitable for plates	



Eppendorf ThermoMixer® C



More about ThermoMixer C



www.eppendorf.link/ThermomixerC

Description

Eppendorf ThermoMixer C is for heating, cooling, and mixing almost any of your lab vessels. Efficient mixing of your samples is executed by ^{2D}Mix technology.

Product features

- > Mixing, heating, and cooling in one instrument for high flexibility
- > All common vessels and plate formats from 5 µL to 50 mL by different Eppendorf SmartBlocks for standard applications
- > Ideal for cell thawing when using Eppendorf SmartBlock cryo thaw

	Plate type	96-well plates	384-well plates
Mixing of different buffers			
Buffer with detergent	PCR	30 s 1,800 rpm	30 s 2,800 rpm
Buffer without detergent	PCR	1 min 2,000 rpm	30 s 3,000 rpm
Buffer with high salt concentration	DWP	5 s 1,400 rpm	30 s 2,000 rpm
Buffer with DMSO	MTP	5 s 1,100 rpm	5 s 2,000 rpm
Mixing of viscous solutions			
Genomic-DNA	PCR	30 s 2,000 rpm	1 min 3,000 rpm
Resuspension of pellets			
Bacteria cell pellets	DWP	30 s 2,000 rpm	2 min 2,000 rpm

Eppendorf ThermoMixer C provides enough mixing power to handle challenging mixing tasks. Most samples are efficiently mixed within less than a minute independent of vessel geometry or sample properties. For more informations see AppNote 130.

Ordering information

Description	Order no.
Eppendorf ThermoMixer® C, basic device without thermoblock, 220 – 240 V/50 – 60 Hz (GB)	5382000031

✎ Ordering information for other voltage options can be found in the “Voltage Version” chapter.

50 µL sample mixing with 1,800 rpm

Competitor 1 min



Suboptimal sample mixing

Eppendorf ^{2D}Mix-Control 1 min (MixMate®)



Reliable sample mixing

Eppendorf ^{2D}Mix-Control 1 min (Eppendorf ThermoMixer®)



Reliable sample mixing



Eppendorf ThermoStat C



Get more
information



www.eppendorf.link/ThermostatC



The ideal device to accurately set and maintain temperatures:
The Eppendorf ThermoStat C is for heating and cooling almost any of your lab vessels. For additional condensation prevention of small volumes we recommend the Eppendorf ThermoTop (optional), a heated lid with condens.protect technology.

Product features

- > Heating and active cooling in all common vessel and plate formats from 5 μ L to 50 mL for high flexibility
- > Broad range of Eppendorf SmartBlocks enables high vessel flexibility
- > Excellent temperature accuracy for safe sample handling

Ordering information

Description

Eppendorf ThermoStat C, basic device without thermoblock, 220 – 240 V/50 – 60 Hz (GB)

ThermoTop[®], with condens.protect technology

SmartExtender, 1.5 mL

Order no.

[5383000035](#)

[5308000003](#)

[5322000008](#)

✎ Ordering information for other voltage options can be found in the “Voltage Version” chapter.



Your local distributor: www.eppendorf.link/contact

Eppendorf UK Limited · Gateway 1000 · Whittle Way · Stevenage SG1 2FP · United Kingdom · sales@eppendorf.co.uk · www.eppendorf.com · www.eppendorf.link/eshop



Eppendorf ThermoMixer® F



Product features

- > Heating and mixing in 0.5/1.5/2.0 mL reaction vessels (F0.5/F1.5/F2.0) or plates (FP)
- > Up to 1,500 rpm (F1.5/F2.0) or 2,000 rpm (F0.5/FP) for efficient sample mixing
- > Outstanding ^{2D}Mix-Control technology results in excellent mixing performance

Check out more



www.eppendorf.link/ThermomixerF

Doing a lot of routine mixing and heating?

These products are the perfect choice for mixing and heating established routine applications. The Eppendorf ThermoMixer F0.5/F1.5/F2.0 and FP have a fixed block for 0.5/1.5/2.0 mL tubes and plates, respectively. Reliable prevention of condensate formation in small vessels can be achieved with the heated lid Eppendorf ThermoTop (optional).

Ordering information

Description	Order no.
Eppendorf ThermoMixer® FP, with thermoblock for microplates and deepwell plates, including lid, 220 – 240 V/50 – 60 Hz (GB)	5385000032
Eppendorf ThermoMixer® F0.5, with thermoblock for 24 reaction vessels 0.5 mL, 220 – 240 V/50 – 60 Hz (GB)	5386000036
Eppendorf ThermoMixer® F1.5, with thermoblock for 24 reaction vessels 1.5 mL, 220 – 240 V/50 – 60 Hz (GB)	5384000039
Eppendorf ThermoMixer® F2.0, with thermoblock for 24 reaction vessels 2.0 mL, 220 – 240 V/50 – 60 Hz (GB)	5387000030

✂ Ordering information for other voltage options can be found in the “Voltage Version” chapter.



MixMate®



Straight mixing required? The 3-in-1 mixer for plates, tubes, and vortex mixing. This high speed instrument provides complete mixing of your samples in seconds. Remarkable ^{2D}Mix-Control enables optimized mixing with anti-spill technology.

Product features

- > High-speed mixer (up to 3,000 rpm) for fast and efficient mixing of small volumes in all common vessel formats up to 50 mL
- > ^{2D}Mix-Control technology (planar mixing orbit without vertical movement) for controlled mixing and reproducible results in seconds
- > Anti-spill technology for controlled mixing movements without lid wetting and cross-contamination

Get more information



www.eppendorf.link/Mixmate

	Plate type	96-well plates	384-well plates
Mixing of different buffers			
Buffer with detergent	PCR	15 s	45 s
		1,800 rpm	2,800 rpm
Buffer without detergent	PCR	30 s	30 s
		2,100 rpm	3,000 rpm
Buffer with high salt concentration	DWP	5 s	1 min
		1,400 rpm	2,000 rpm
Buffer with DMSO	MTP	5 s	5 s
		1,100 rpm	2,200 rpm
Mixing of viscous solutions			
Genomic-DNA	PCR	30 s	45 s
		2,000 rpm	3,000 rpm
Resuspension of pellets			
Bacteria cell pellets	DWP	30 s	3 min
		2,000 rpm	2,000 rpm

MixMate provides enough mixing power to handle the most challenging mixing tasks. Most samples are efficiently mixed within less than a minute independent of vessel geometry or sample properties. For more information see AppNote 130.

Ordering information

Description	Order no.
MixMate®, basic device without tube holders, 230 V/50 – 60 Hz (GB)	5353000537
Tube Holder 0.5 mL, for 24 × 0.5 mL reaction vessels	5353040121
Tube Holder 1.5/2.0 mL, for 24 × 1.5 mL or 2.0 mL reaction vessels	5353040130
Tube Holder 5/15 mL, for 8 × 5/15 mL conical tubes	5353040148
Tube Holder 25/50 mL, for 4 × 25/50 mL conical tubes	5353040156
Tube Holder PCR 96, for 96 × 0.2 mL PCR tubes, PCR strips or 1 × 96-well PCR plate, semi-skirted or unskirted	5353040113

✎ Ordering information for other voltage options can be found in the “Voltage Version” chapter.





ThermoTop®

Having non-regular enzymatic results after temperature incubation?

The ThermoTop with condens.protect technology heated lid avoids condensation on tube lid and tube wall. It is compatible with Eppendorf ThermoMixer C/ Eppendorf ThermoStat C with SmartBlock plates and lab vessels up to 2 mL and Eppendorf ThermoMixer F 0.5/F1.5/F2.0/FP.



Product features

- > Efficient and reliable of condensation prevention for safe sample heating
- > Get stable reaction conditions for optimal enzymatic performance within your samples
- > Wireless connection with automatic recognition and operation for user-friendly handling

Ordering information

Description	Order no.
ThermoTop®, with condens.protect technology	530800003

SmartExtender

Do you need a second temperature or more space for incubation steps?

The Eppendorf SmartExtender offers a comfortable incubation tool which can easily be used as an add-on to your existing SmartBlocks and the Eppendorf ThermoMixer® C/F as well as Eppendorf ThermoStat C.



Product features

- > Independent temperature set-up for parallel application
- > Up to 12 × 1.5 mL vessels
- > Temperature range from 3 °C above room temperature to 110 °C

Ordering information

Description	Order no.
SmartExtender, 1.5 mL	532200008

IsoTherm-System®

The IsoTherm-System is the ideal system for safely cooling your samples in 1.5 mL/2.0 mL tube formats at -21°C or 0°C throughout your entire lab workflow.



Ordering information

Description	Order no.
IsoTherm-System® starter set , includes IsoSafe, IsoRack, 0 °C IsoPack and -21 °C IsoPack, for 1.5/2.0 mL tubes	3880001018
IsoPack and IsoRack set , includes one IsoPack and one IsoRack for 1.5/2.0 mL vessels, 0 °C	3880001166
for 1.5/2.0 mL vessels, -21 °C	3880001174



Eppendorf SmartBlock

Interchangeable in just seconds.

These incredibly sensor-controlled SmartBlocks are your solution for maintaining accurate, uniform temperatures. The flexible thermoblocks are compatible with common lab vessels to support a broad range of applications - for use with Eppendorf ThermoMixer® C (heating/ cooling and mixing) and Eppendorf ThermoStat C (heating/ cooling).



Eppendorf SmartBlocks for the following reaction vessels:

- A. 24 lab vessels up to 12 mm in diameter
- B. 8 × 15 mL conical tubes
- C. 4 × 50 mL conical tubes
- D. Eppendorf Deepwell Plates 96/500 μ L
- E. Eppendorf Deepwell Plates 96/1000 μ L
- F. 24 × cryo tubes
- G. 8 × Eppendorf Tubes® 5.0 mL
- H. Lid for Eppendorf SmartBlock plates, PCR 96, PCR 384, DWP, 0.5 mL, 1.5 mL and 2.0 mL
- I. 384-well PCR plates
- J. 96-well PCR plates
- K. 24 × 0.5 mL vessels
- L. 24 × 1.5 mL vessels
- M. 24 × 2.0 mL vessels
- N. MTPs and Deepwell Plates
- O. 4 × 25 mL adapter for SmartBlock 50 mL

Product features

- > Optimized block design supports optimal temperature transfer to your sample to achieve excellent results
- > Eppendorf SmartBlock-specific calibration by integrated sensor technology maximizes temperature accuracy and homogeneity
- > Every Eppendorf SmartBlock is individually inspected in production for temperature accuracy and includes a serial-number specific certificate for documentation purpose

SmartBlocks can only be used with ThermoMixer C and ThermoStat C

Get more
details



www.eppendorf.link/Smartblock

Ordering information

Description	Order no.
Eppendorf SmartBlock cryo thaw , thermoblock for 24 cryo tubes, 1.5 mL – 2 mL, max. external diameter 12.7 mm, flat base. Replaces order no. 5367000025.	5318000001
Eppendorf SmartBlock 0.5 mL , thermoblock for 24 reaction vessels 0.5 mL, incl. Transfer Rack 0.5 mL	5361000031
Eppendorf SmartBlock 1.5 mL , thermoblock for 24 reaction vessels 1.5 mL, incl. Transfer Rack 1.5/2.0 mL	5360000038
Eppendorf SmartBlock 2.0 mL , thermoblock for 24 reaction vessels 2.0 mL, incl. Transfer Rack 1.5/2.0 mL	5362000035
Eppendorf SmartBlock 5 mL , thermoblock for 8 Eppendorf Tubes® 5.0 mL, 8 × 5.0 mL reaction vessels	5309000007
Eppendorf SmartBlock 15 mL , thermoblock for 8 conical tubes 15 mL	5366000021
Adapter 25 mL for Eppendorf SmartBlock 50 mL , Set consisting of 4 adapters and removal tool	5365000109
Eppendorf SmartBlock 50 mL , thermoblock for 4 conical tubes 50 mL	5365000028
Eppendorf SmartBlock 12 mm , thermoblock for 24 reaction vessels, diameter up to 12 mm, height 35 mm – 76 mm	5364000024
Eppendorf SmartBlock PCR 96 , thermoblock for PCR plates 96, incl. lid	5306000006
Eppendorf SmartBlock PCR 384 , thermoblock for PCR plates 384, incl. lid	5307000000
Eppendorf SmartBlock DWP 500 , thermoblock for Eppendorf Deepwell Plates 96/500 μ L, incl. lid	5316000004
Eppendorf SmartBlock DWP 1000 , thermoblock for Eppendorf Deepwell Plate 96/1,000 μ L, incl. lid	5310000002
Eppendorf SmartBlock plates , thermoblock for microplates and Deepwell Plates, incl. lid	5363000039
Lid , for Eppendorf ThermoMixer® F0.5/F1.5/F2.0 and FP, for Eppendorf SmartBlock 0.5 – 2.0 mL, plates, PCR 96, PCR 384, and DWP	5363000233
Transfer Rack 0.5 mL , for Eppendorf SmartBlock 0.5 mL	3880000305
Transfer Rack 1.5/2.0 mL , for Eppendorf SmartBlock 1.5 mL and Eppendorf SmartBlock 2.0 mL	3880000151



Your local distributor: www.eppendorf.link/contact

Eppendorf UK Limited · Gateway 1000 · Whittle Way · Stevenage SG1 2FP · United Kingdom · sales@eppendorf.co.uk · www.eppendorf.com · www.eppendorf.link/eshop

Tubes and Plates

Protect Your Sample

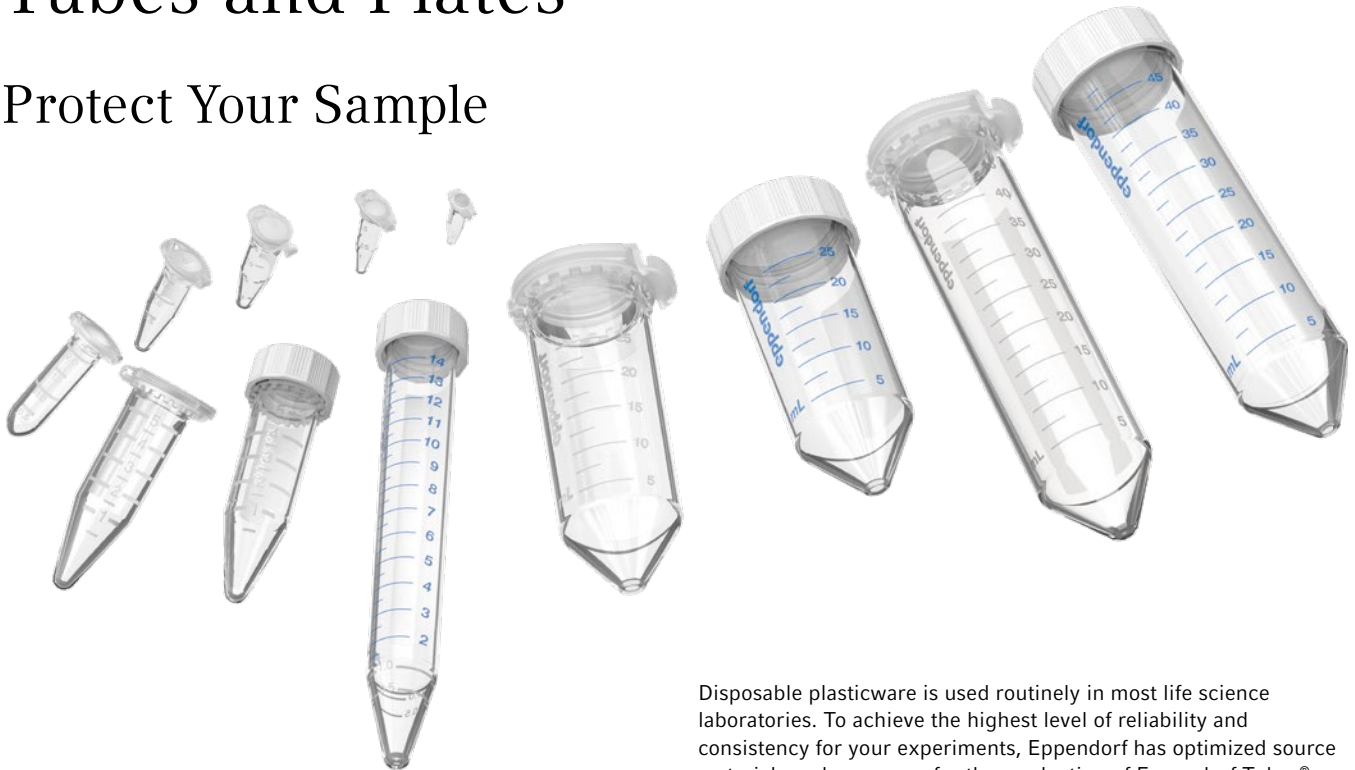

Eppendorf Tubes®

- > Made of high quality, virgin polypropylene (PP), free of biocides, plasticizers and latex
- > Produced with optimized, highly polished molds without the use of slip agents like oleamide, erucamide, stearamide
- > Produced with dyes free of organic additives and heavy metals (applies for screw caps and Amber variants)
- > Designed and manufactured under ISO 13485 and ISO 9001 certified Quality Management System
- > Full traceability is provided for each product back to material lot

Disposable plasticware is used routinely in most life science laboratories. To achieve the highest level of reliability and consistency for your experiments, Eppendorf has optimized source materials and processes for the production of Eppendorf Tubes® to minimize the risk of interference. The effects from chemical substances such as slip agents, plasticizers or biocides leaching out of plastic consumables are still frequently underestimated in the majority of life science applications.

However, increasing scientific evidence shows that this heterogeneous group of chemicals may significantly affect experiments and pose a likely source of error in various assay systems. They slow down evaporation, skew absorbance readings and lead to erroneous DNA quantification. Some of these slip agents have also been shown to negatively affect the outcome of biological tests like enzyme activity or receptor-binding assays.



Effective light protection in amber tubes

Numerous types of light-sensitive reagents and samples are often used in the laboratory routine. Once exposed to light, their quality, longevity or activity may rapidly decrease and therefore adversely affect subsequent assays and experiments. To avoid these issues, light-sensitive reagents and samples must be handled and stored in a manner that protects them from direct light exposure. Amber-colored laboratory plastic tubes reduce or completely block light transmission, and thus allow safe storage and handling of light-sensitive samples.

Light protection meets transparency

While providing good sample protection against high-energy light in the short wavelength UV/VIS spectrum, amber tubes often come with a major drawback: They are opaque and therefore do not allow for a clear view of the sample. Designed specifically for eppendorf conical tubes from 5 mL to 50 mL, our amber material has an optimized degree of transparency to allow for full visibility of the sample, offering full control over pipette tip insertion depth and providing a clear advantage in sample handling and contamination prevention.

Get all information about the Eppendorf tubes portfolio!

Download the brochure!

www.eppendorf.link/tubes-brochure



Quality Starts Here



High Quality for your Application Needs
Eppendorf Plates® are produced, handled, stored, and delivered according to our premium quality and purity standards – that is what our customers call the Eppendorf Quality. Our plates are manufactured from carefully selected and purest raw materials that comply with international criteria for maximum purity.

Fully automated production in clean room conditions removes any human interaction and possible contamination. With the particularly strict control criteria, internally and externally monitored, we guarantee the superior consistency of our products and your results.

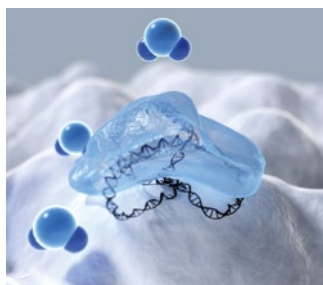

www.eppendorf.link/appnote382

DNA LoBind® – Recover your nucleic acids

When dealing with low concentrations of nucleic acids, any sample loss could make downstream steps difficult. For example, in workflows including preparation and setup of PCR applications, loss of DNA on vessel surfaces can affect the performance of individual processing steps and can lead to misinterpretation of results. DNA LoBind Tubes and Plates maximize sample recovery of nucleic acids by significantly reducing sample-to-surface binding. They represent the ideal solution for preparing and storing samples containing low amounts of DNA. To minimize the risk of sample loss, the DNA LoBind properties are achieved without surface coating.

Applications

- > Preparation or storage of DNA and RNA samples
- > Forensic trace analysis
- > Preparing dilution series in quantitative qPCR
- > Sample preparation in next-generation sequencing
- > Creation of genomic or oligonucleotide libraries

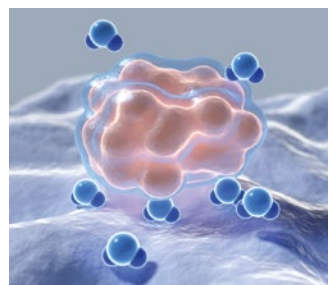

www.eppendorf.link/appnote404

Protein LoBind® – Get the most out of your applications

Protein preparation and storage represent critical steps in a wide range of laboratory applications. Unspecific adsorption of up to 90% of protein molecules or peptides to the polymer surface of the inner walls of tubes can significantly contribute to sample loss within 24 hours and artificially affect experimental results. Eppendorf Protein LoBind Tubes and Plates are specifically designed for use in applications where protein concentrations tend to be small and sample recovery is vital for assay results. A special, two-component polymer mix creates a hydrophilic surface that ensures optimized recovery rates of valuable samples.

Applications

- > Preparation or storage of protein, peptide or antibody samples
- > Storage of virus stock solutions
- > Sample preparation in toxicology
- > Storage of cell suspensions
- > Enzymatic assays

Get all information about the Eppendorf plates portfolio!
Download the brochure!

www.eppendorf.link/plates-brochure



Our Portfolio – Your Choice



Model	Tube 3810X	Safe-Lock Tube 0.5 mL	Safe-Lock Tube 1.5 mL	Safe-Lock Tube 2.0 mL
Page(s)	10	9	9	9
Volume	1.5 mL	0.5 mL	1.5 mL	2.0 mL
Bottom shape	conical	conical	conical	round
Max. RCF	30,000 × g	30,000 × g	30,000 × g	25,000 × g
Eppendorf Quality				
Max. RCF PCR clean	30,000 × g	30,000 × g	30,000 × g	25,000 × g
Max. RCF Biopur®	–	22,000 × g	22,000 × g	22,000 × g
Max. RCF sterile	–	–	–	–
Max. RCF	–	22,000 × g	22,000 × g	22,000 × g
Forensic DNA Grade				
Light protection	no	yes	yes	yes

¹⁾ Test conditions: Rotor FA-45-6-30 in Eppendorf Centrifuge 5810 R (using a suitable centrifuge adapter for 15 mL tube), sample: saline solution (density: 1.0 g/mL), controlled centrifugation temp.: 25 °C, centrifugation time: 90 min



Model	Protein LoBind® Tubes/ snap cap, DNA LoBind®, 0.5 mL	Protein LoBind® Tubes/ snap cap, DNA LoBind®, 1.5 mL	Protein LoBind® Tubes/ snap cap, DNA LoBind®, 2.0 mL
Page(s)	18/19	18/19	18/19
Bottom shape	conical	conical	conical
Max. RCF PCR clean	18,000 × g/ 30,000 × g	18,000 × g/ 30,000 × g	18,000 × g/ 25,000 × g

¹⁾ Test conditions: Rotor FA-45-6-30 in Eppendorf Centrifuge 5810 R (using a suitable centrifuge adapter for 15 mL tube), sample: saline solution (density: 1.0 g/mL), controlled centrifugation temp.: 25 °C, centrifugation time: 90 min

Get all information about the Eppendorf tubes portfolio!
Explore the eshop and get an overview!

www.eppendorf.link/tubes



Tubes and Plates



Eppendorf Tubes® 5.0 mL	Eppendorf Conical Tubes 15 mL	25 mL SnapTec® cap/ 25 mL screw cap	Eppendorf Conical Tubes 50 mL	Eppendorf Conical Tubes SnapTec® 50
10	14	12	14	15
5.0 mL	15 mL	25 mL	50 mL	45 mL
conical	conical	conical	conical	conical
25,000 × g	–	17,000 × g	–	17,000 × g
25,000 × g	–	17,000 × g	–	17,000 × g
25,000 × g	–	–	–	–
25,000 × g	19,500 × g ¹⁾	17,000 × g	19,500 × g ¹⁾	17,000 × g
25,000 × g	19,500 × g ¹⁾	–	19,500 × g ¹⁾	17,000 × g
yes	yes	yes	yes	no



Protein LoBind® Tubes/ snap cap, DNA LoBind®, 5.0 mL	Protein LoBind® Tubes/ screw cap, DNA LoBind®, 15 mL, conical tubes	Protein LoBind® Tubes/ SnapTec® cap, DNA LoBind®, 25 mL, conical tubes	Protein LoBind® Tubes/ screw cap, DNA LoBind®, 50 mL, conical tubes
18/19	18/19	18/19	18/19
conical	conical	conical	conical
25,000 × g/ 25,000 × g	19,500 × g	14000 × g ¹⁾ / 17,000 × g	19,500 × g

Our Portfolio – Your Choice



Microplates

Model	MTP 96/F	MTP 96/U	MTP 96/V
Page(s)	20	20	20
Number of wells	96 wells	96 wells	96 wells
Total volume per well	400 μ L	360 μ L	350 μ L
Working volume	50 – 350 μ L	20 – 320 μ L	20 – 320 μ L
Material	polypropylene (PP)	polypropylene (PP)	polypropylene (PP)
Bottom shape	F bottom	U bottom	V bottom
Dimensions (W x D x H)	127.8 x 85.5 x 14.4 mm	127.8 x 85.5 x 14.4 mm	127.8 x 85.5 x 14.4 mm
Max. RCF	6,000 x g	6,000 x g	6,000 x g



Deepwell Plates

Model	DWP 96/500	DWP 96/1000	DWP 96/2000	DWP 384/200
Page(s)	22	22	22	22
Number of wells	96 wells	96 wells	96 wells	384 wells
Total volume per well	700 μ L	1,200 μ L	2,400 μ L	240 μ L
Working volume	30 – 550 μ L	30 – 1,000 μ L	50 – 2,000 μ L	20 – 225 μ L
Material	polypropylene (PP)	polypropylene (PP)	polypropylene (PP)	polypropylene (PP)
Bottom shape	conical	conical	conical	conical
Dimensions (W x D x H)	127.8 x 85.5 x 27.1 mm	127.8 x 85.5 x 44.1 mm	127.8 x 85.5 x 44.1 mm	127.8 x 85.5 x 25.1 mm
Max. RCF	6,000 x g	6,000 x g	6,000 x g	6,000 x g

Get all information about the Eppendorf plates portfolio!
Explore the eshop and get an overview!

www.eppendorf.link/plates





Eppendorf Purity Grades for Tubes and Plates

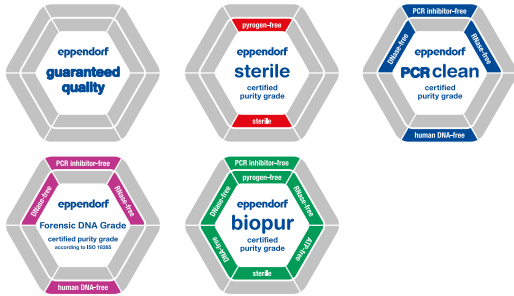

Pure Quality at
Eppendorf

www.eppendorf.link/purity



Eppendorf sample handling consumables stand for highest quality and purity

Our tubes and plates are available in a variety of purity grades (see table below). The purity grades “sterile”, “PCR clean”, “Biopur®” and “Forensic DNA Grade” are certified by an ISO 17025 accredited external lab. As a special service, we make the lot-specific certificates available online (www.eppendorf.com/certificates).

Purity grades

Eppendorf purity grades for tubes and plates

	Eppendorf Quality	Eppendorf sterile	Eppendorf PCR clean	Eppendorf Forensic DNA Grade ⁵⁾	Eppendorf Biopur®
Continuous quality control for the following relevant criteria:					
Function, tightness, precision	■	■	■	■	■
Low wetting	■	■	■	■	■
High chemical resistance	■	■	■	■	■
High thermal resistance	■	■	■	■	■
High resistance to centrifugation forces ¹⁾	■	■	■	■	■
High transparency	■	■	■	■	■
Precisely shaped	■	■	■	■	■
Lot-specific certificates²⁾ for the following purity criteria:					
Pyrogen-free ⁶⁾ (endotoxin-free)		■			■
Sterile (Ph.Eur./USP)		■			■
DNA-free ⁶⁾ (Human DNA)			■	■	■
DNA-free ⁶⁾ (Bacteria DNA)					■
DNase-free ⁶⁾			■	■	■
RNase-free ⁶⁾			■	■	■
PCR-inhibitor-free ⁶⁾			■	■	■
ATP-free ⁶⁾					■
Eppendorf Tubes®					
Safe-Lock Tubes	■		■	■	■ ³⁾
Flex-Tubes®/ 3810X	■		■		
Eppendorf Tubes® 5.0 mL	■	■	■	■	■ ³⁾
Eppendorf Conical Tubes 25 mL	■	■ ⁴⁾	■		
Eppendorf Conical Tubes 15 mL and 50 mL		■ ⁴⁾		■ ³⁾	
DNA and Protein LoBind Tubes			■		
PCR Tubes (PCR and real-time PCR)			■	■	
Cap Strips (PCR and real-time PCR)			■		
Eppendorf Plates® and accessories					
Deepwell Plates and Microplates		■	■		
Protein LoBind Deepwell Plates			■		
DNA LoBind Deepwell Plates			■		
Eppendorf twin.tec® PCR Plates			■	■ ³⁾	
Heat Sealing Film and Foil			■		
PCR Storage Films and Foils			■		
Plate Lid		■	■		

¹⁾ For accurate details regarding resistance to centrifugation, please refer to the respective product pages. ²⁾ Lot-specific certificate can be downloaded from www.eppendorf.com/certificates. ³⁾ Individually packaged. ⁴⁾ Eppendorf sterile, RNase free, DNase free, DNA free. Testing showed conformity within the detection limits (human and bacteria DNA) ⁵⁾ According to ISO 18385. ⁶⁾ Testing showed conformity within the detection limits



Eppendorf Safe-Lock Tubes



Unrivaled for Decades

Eppendorf Safe-Lock Tubes are the result of 50 years of continuous improvement and development. The hinged Eppendorf Safe-Lock lid provides outstanding protection against unintentional opening during incubation and storage. Trust in the original Eppendorf Safe-Lock Tubes, because your samples deserve nothing but the best.

Product features

- > Hinged Eppendorf Safe-Lock lid prevents unintentional lid opening during incubation and storage
- > g-Safe®: Depending on Safe-Lock Tube variant (see manual) exceptional centrifugation stability up to 30,000 × g prevents sample loss due to tube breakage and provides extra safety when working with hazardous samples
- > Manufactured without the use of slip agents, plasticizers, and biocides – substances that have been shown to leach from plastic consumables into the sample and negatively affect bio-assay results

Ordering information

Description	Order no.
Eppendorf Safe-Lock Tubes, 0.5 mL	
Eppendorf Quality, colorless, 500 tubes. Replaces order no. 0030121503.	0030121023
Eppendorf Quality, yellow, 500 tubes	0030121112
Eppendorf Quality, red, 500 tubes	0030121120
Eppendorf Quality, blue, 500 tubes	0030121139
Eppendorf Quality, green, 500 tubes	0030121147
Eppendorf Quality, assorted colors (per 100), 500 tubes	0030121708
PCR clean, amber (light protection), 500 tubes	0030121155
PCR clean, colorless, 500 tubes	0030123301
Biopur®, colorless, 50 tubes, individually packed	0030121570
Forensic DNA Grade, colorless, 500 tubes (10 bags × 50 tubes)	0030123603
Eppendorf Safe-Lock Tubes, 1.5 mL	
Eppendorf Quality, colorless, 1,000 tubes. Replaces order no. 0030121872.	0030120086
Eppendorf Quality, yellow, 1,000 tubes	0030120159
Eppendorf Quality, red, 1,000 tubes	0030120167
Eppendorf Quality, blue, 1,000 tubes	0030120175
Eppendorf Quality, green, 1,000 tubes	0030120183
Eppendorf Quality, assorted colors (per 200), 1,000 tubes	0030121694
PCR clean, amber (light protection), 1,000 tubes	0030120191
PCR clean, colorless, 1,000 tubes	0030123328
Biopur®, colorless, 100 tubes, individually packed	0030121589
Forensic DNA Grade, colorless, 500 tubes (10 bags × 50 tubes)	0030123611
Eppendorf Safe-Lock Tubes, 2.0 mL	
Eppendorf Quality, colorless, 1,000 tubes. Replaces order no. 0030121880.	0030120094
Eppendorf Quality, yellow, 1,000 tubes	0030120205
Eppendorf Quality, red, 1,000 tubes	0030120213
Eppendorf Quality, blue, 1,000 tubes	0030120221
Eppendorf Quality, green, 1,000 tubes	0030120230
Eppendorf Quality, assorted colors (per 200), 1,000 tubes	0030121686
PCR clean, amber (light protection), 1,000 tubes	0030120248
PCR clean, colorless, 1,000 tubes	0030123344
Biopur®, colorless, 100 tubes, individually packed	0030121597
Forensic DNA Grade, colorless, 500 tubes (10 bags × 50 tubes)	0030123620
Storage Box 8 × 8 , freezer box, for 64 tubes 1 – 2 mL, 3 pcs., height 53 mm, 2 in, polypropylene, for freezing to -86 °C, autoclavable, with lid and alphanumeric code	0030140524
Eppendorf Tube Rack , 36 positions, for 1.5 mL and 2.0 mL tubes, polypropylene, numbered positions, autoclavable, 2 pcs.	0030119819





Eppendorf Tubes® 3810X



The Original

The easy-open, easy-close design of the Eppendorf Tubes® 3810X provides convenient, ergonomic, and reliable one-handed operation. Whether sample preparation, centrifugation or storage – the Eppendorf Tubes® 3810X fit perfectly into your workflows!

Product features

- > Tube lid is easy to open and close for ergonomic operation
- > Polypropylene provides high resistance to chemicals, mechanical stress, and temperature extremes
- > g-Safe®: Exceptional centrifugation stability up to 30,000 × g prevents sample loss due to tube breakage and provides extra safety when working with hazardous samples

Ordering information

Description	Order no.
Eppendorf Tubes® 3810X , 1.5 mL, g-safe® centrifugation stability	
Eppendorf Quality, colorless, 1,000 pcs.	0030125150
Eppendorf Quality, yellow, 1,000 pcs.	0030125207
Eppendorf Quality, red, 1,000 pcs.	0030125193
Eppendorf Quality, blue, 1,000 pcs.	0030125177
Eppendorf Quality, green, 1,000 pcs.	0030125185
PCR clean, colorless, 1,000 pcs.	0030125215
Storage Box 8 × 8 , freezer box, for 64 tubes 1 – 2 mL, 3 pcs., height 53 mm, 2 in, polypropylene, for freezing to -86 °C, autoclavable, with lid and alphanumeric code	0030140524
Eppendorf Tube Rack , 36 positions, for 1.5 mL and 2.0 mL tubes, polypropylene, numbered positions, autoclavable, 2 pcs.	0030119819

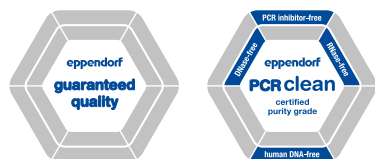

Eppendorf Tubes® 5.0 mL



The Missing Link!

Eppendorf Tubes® 5.0 mL. This product represents the perfect option for working with medium-sized sample volumes. It fills the gap between existing tube formats and enables the simple and safe processing of sample volumes up to 5.0 mL.

Product features

- > Ergonomic operation: Snap cap - simple, practical and ergonomic singlehand operation. Screw cap - flattened and grooved sides provide optimal grip and user-friendly handling
- > Broad operating temperature range: Screw cap tubes: -86 °C – 100 °C. Snap cap tubes: -86 °C – 80 °C (when using the clip ≤ 100 °C)
- > Material: Exceptionally high-quality, transparent polypropylene, free of plasticizers, biocides or mold release agents, for reliable test results



www.eppendorf.link/5mL



Light Protection as well as Transparency

The amber colored Eppendorf Tubes® 5.0 mL with screw cap combine effective protection of your sensitive samples from energy-rich light in the lower wavelength range with a high degree of transparency. You get full control on the insertion depths of pipette tips - often a source of contamination when handling solutions in intransparent tube formats.

Ordering information

Description	Order no.
Eppendorf Tubes® 5.0 mL, snap cap, 5.0 mL	
Eppendorf Quality, colorless, 200 tubes (2 bags × 100 tubes)	0030119401
PCR clean, colorless, 200 tubes (2 bags × 100 tubes)	0030119460
Biopur®, colorless, 50 tubes, individually wrapped	0030119479
Forensic DNA Grade, colorless, 200 tubes (4 bags × 50 tubes)	0030119606
sterile, colorless, 200 tubes (10 bags × 20 tubes)	0030119487
PCR clean, amber (light protection), 200 tubes (2 bags × 100 tubes)	0030119452
Eppendorf Tubes® 5.0 mL, screw cap, 5.0 mL	
Eppendorf Quality, colorless, 200 tubes (2 bags × 100 tubes). Replaces order no. 0030119517.	0030122305
PCR clean, colorless, 200 tubes (2 bags × 100 tubes)	0030122313
sterile, pyrogen-, DNase-, RNase-, human and bacterial DNA-free, colorless, 200 tubes (2 bags × 100 tubes)	0030122321
Forensic DNA Grade, colorless, 200 tubes (2 bags × 100 tubes)	0030122402
sterile, pyrogen-, DNase-, RNase-, human and bacterial DNA-free, amber (light protection), 200 tubes (2 bags × 100 tubes)	0030122330
Eppendorf Tubes® 5.0 mL starter pack, snap cap, 5.0 mL, 400 tubes (2 packages with 2 bags of 100 each), 2 racks (with 12 locations each), white, 8 universal adapters for rotors with bore holes for 15 mL conical tubes, PCR clean, colorless	0030119380
Eppendorf Tubes® 5.0 mL, starter pack, screw cap, 5.0 mL, 400 tubes (2 packages with 2 bags of 100 each), 2 racks (with 12 locations each), white, 8 universal adapters for rotors with bore holes for 15 mL conical tubes, PCR clean, colorless	0030122364

Ordering information for DNA and Protein LoBind Tubes can be found at page 19

Ordering information

Description	Order no.
Eppendorf Tubes® 5.0 mL – System Accessories, 5.0 mL	
Tube Clip for Eppendorf Tubes® 5.0 mL, 5.0 mL, Eppendorf Quality, 10 pcs.	0030119509
Eppendorf Tube Rack, 12 positions, for 5.0 mL and 15 mL tubes, polypropylene, numbered positions, autoclavable, 2 pcs.	0030119827
Storage Box 5 × 5, freezer box, for 25 tubes 5 mL, 4 pcs., height 64 mm, 2.5 in, polypropylene, for freezing to -86 °C, autoclavable, with lid and alphanumeric code	0030140532
Storage Box 5 × 5, freezer box, for 25 tubes 5 mL screw cap, 2 pcs., height 76 mm, 3 in, polypropylene, for freezing to -86 °C, autoclavable, with lid and alphanumeric code	0030140613
Rotor FA-45-12-17, aerosol-tight, incl. rotor lid, aluminum	5409700006
Rotor FA-45-16-17, aerosol-tight, incl. rotor lid, for 16 × Eppendorf Tubes® 5.0 mL	5427750002
Rotor FA-45-20-17, incl. rotor lid, for 20 Eppendorf Tubes® 5.0 mL	5820765003
Adapter, for 14 Eppendorf Tubes® 5.0 mL, for Rotor S-4-104, Rotor S-4x1000 round buckets and Rotor S-4x750, 2 pcs.	5825739000
Adapter, for 1 Eppendorf Tubes® 5.0 mL, 17 mm × 60 mm, for 100 mL round bucket in Rotor A-4-38, 2 pcs.	5702733008
Adapter, for 1 Eppendorf Tubes® 5.0 mL, for Rotor F-35-6-30, large rotor bore, 2 pcs.	5427747001
Adapter, for 1 Eppendorf Tubes® 5.0 mL, for Rotor F-34-6-38, 2 pcs.	5804777000
Adapter, for 1 Eppendorf Tubes® 5.0 mL, for Rotor F-35-6-30, small rotor bore, 2 pcs.	5427746005
Adapter, for 1 Eppendorf Tubes® 5.0 mL with snap cap, for Rotor FA-45-6-30 and FA-6x50, 2 pcs.	5820730005
Universal adapter, for 1 Eppendorf Tubes® 5.0 mL, for rotors for conical 15 mL tubes, 8 pcs.	5820732008
Adapter, for 8 Eppendorf Tubes® 5.0 mL, for Rotor S-4-72, 2 pcs.	5804793005
Exchangeable thermoblocks, for 8 × Eppendorf Tubes® 5.0 mL	5309000333
Eppendorf SmartBlock 5 mL, thermoblock for 8 Eppendorf Tubes® 5.0 mL, 8 × 5.0 mL reaction vessels	5309000007
ReservoirRack Module TC, for use in epMotion® ReservoirRacks, temperable, 4 × Eppendorf Tubes® 5.0 mL	5075799340





Eppendorf Conical Tubes 25 mL



The Next Level – Eppendorf Conical Tubes 25 mL!

This member of the big Eppendorf Tube Family fills the gap between the volumes of traditional conical tubes of 15 mL and 50 mL. Optimized height and outstanding quality make these conical tubes ideally suited for cell biology tasks such as for pooling media from T75 flasks, bacteria culture in midi prep size or overlapping applications like buffer preparation, storage and transport.

Also available in Amber for UV-light sensitive samples and in DNA LoBind and Protein LoBind.

Product features

- > Reduced height gives easy sample access even with low-volume pipettes and tips – reduces risk of cross-contamination between pipette and tube
- > Single-handed opening and closing through SnapTec® cap version for fast liquid extraction and addition
- > Centrifugation stability up to 17,000 x g¹⁾ for both tube variants - SnapTec® cap and screw cap

¹⁾ Please note the Instructions For Use for details (www.eppendorf.com/manuals): "Eppendorf Conical Tubes 25 mL, snap cap" and "Eppendorf Conical Tubes 15, 25 and 50 mL"

Applications

- > Cell culture applications, optimal for pooling, e.g. pooling media from 3 x T75 flasks (25 mL)
- > Sample preparation in microbiology and molecular biology labs, e.g. bacteria culture in midi prep size, cloning, DNA extraction when working with a relatively high amount of biological starting material (in botany)
- > Storage and transport of samples and solutions up to 25 mL
- > Preparation of master mixes and buffers

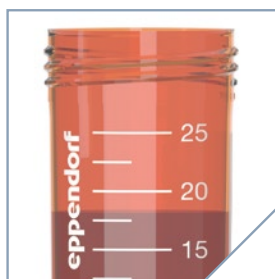
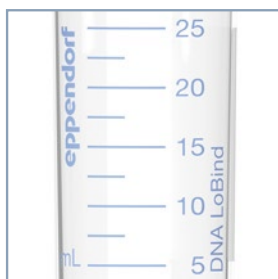

Get more
Information and
watch LoBind and
Amber Video



www.eppendorf.link/conicals



Improved sample processing

Greater diameter and lower height than 15 mL conical tubes enable better sample access and faster resuspension of pellets after centrifugation.



Single-handed operation

Supports optimized and faster handling of sample solutions, especially in multi-step protocols.

A Full System of Components



Centrifugation

Centrifuges with rotors for 50 mL conical tubes, e.g. 59xx series and 58xx series: Two adapter variants for snap cap (order no.: 5820733004) and screw cap (order no.: 5820734000) 25 mL tubes enable usage in 50 mL rotors and buckets.



Sample Storage

Single Tube Stand:

Ideally suited for weighing samples on the balance and for handling individual samples. The viewing slit enables observation of the filling level at any time. (order no.: 0030119860)



Heating and Mixing

Eppendorf ThermoMixer® C and Eppendorf ThermoStat C:

Adapter for 25 mL tubes ensures compatibility with Eppendorf SmartBlock 50 mL. (order no.: 5365000109)



Tube Rack 25 mL:

Eppendorf Racks for 50 mL conical tubes can be used with the new 25 mL tubes. (order no.: 0030119835)



MixMate:

Tube Holder 25/50 mL, for 4 × 25/50 mL conical tubes. (order no.: 5353040156)



Storage box made of polypropylene:

Lower height allows space-saving storage for up to 9 × 25 mL tubes in 3.5 inches Eppendorf Storage Boxes. (order no.: 0030140729)

Ordering information

Description	Order no.
Eppendorf Conical Tubes 25 mL, SnapTec® cap, 25 mL	
sterile, pyrogen-, DNase-, RNase-, human and bacterial DNA-free, amber (light protection), 150 tubes (6 bags × 25 tubes)	0030118430
Eppendorf Quality, colorless, 200 tubes (5 bags × 40 tubes)	0030118405
PCR clean, colorless, 200 tubes (5 bags × 40 tubes)	0030118413
sterile, pyrogen-, DNase-, RNase-, human and bacterial DNA-free, colorless, 150 tubes (6 bags × 25 tubes)	0030118421
Eppendorf Conical Tubes 25 mL, SnapTec® cap, 25 mL,	
Starter Pack, 4 Single Tube Stands, 6 adapters for rotors with bore for 50 mL conical tubes	
PCR clean, colorless, 200 tubes (5 bags × 40 tubes)	0030118502
Eppendorf Conical Tubes 25 mL, screw cap, 25 mL	
sterile, pyrogen-, DNase-, RNase-, human and bacterial DNA-free, amber (light protection), 200 tubes (8 bags × 25 tubes)	0030122445
Eppendorf Quality, colorless, 200 tubes (4 bags × 50 tubes)	0030122410
PCR clean, colorless, 200 tubes (4 bags × 50 tubes)	0030122429
sterile, pyrogen-, DNase-, RNase-, human and bacterial DNA-free, colorless, 200 tubes (8 bags × 25 tubes)	0030122437
Eppendorf Conical Tubes 25 mL, screw cap, 25 mL,	
Starter Pack, 4 Single Tube Stands, 6 adapters for rotors with bore for 50 mL conical tubes	
PCR clean, colorless, 200 tubes (4 bags × 50 tubes)	0030122500

Ordering information for DNA and Protein LoBind Tubes can be found at page 19



Your local distributor: www.eppendorf.link/contact

Eppendorf UK Limited · Gateway 1000 · Whittle Way · Stevenage SG1 2FP · United Kingdom · sales@eppendorf.co.uk · www.eppendorf.com · www.eppendorf.link/eshop



Eppendorf Conical Tubes 15 mL and 50 mL

Conical Competence

The Eppendorf Conical Tubes 15 and 50 mL meet the highest demands of diverse laboratory applications. The excellent quality and specifications make them ideally suited for cell biology applications as well as for sample preparation protocols in microbiology and molecular biology laboratories. The new Eppendorf Conical Tubes SnapTec® 50 allow easy one-handed sample handling.

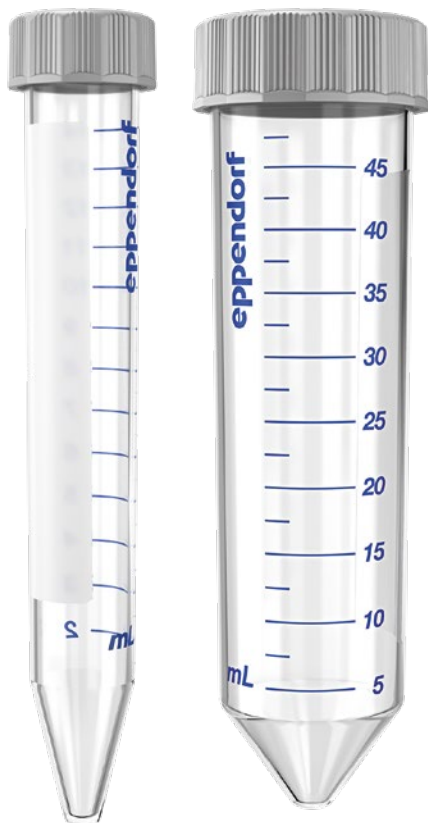

Product features

- > Premium USP class 6 raw material and no use of slip agents, plasticizers, and biocides during manufacturing ensure highest sample integrity, high g-Safe® centrifugation stability, and optimal sample and pellet visibility
- > Cap with flattened and grooved sides supports a user-friendly ergonomic handling, enables a stable upright positioning, and minimizes contamination risk
- > Eppendorf Conical Tubes SnapTec® 50 for fast opening and closing in routine multistep protocols

Applications

- > Convenient and safe cell culture applications
- > Sample preparation in microbiology and molecular biology labs
- > Storage of samples and solutions with larger volumes
- > Preparation of mastermixes and buffers



Whether centrifugation, mixing, or other applications, the Eppendorf Conical Tubes 15 and 50 mL suit your needs.



Light protection as well as transparency - two benefits in one tube.

Ordering information

Description

Eppendorf Conical Tubes, 15 mL

sterile, pyrogen-, DNase-, RNase-, human and bacterial DNA-free, colorless, 500 tubes (10 bags × 50 tubes)

sterile, pyrogen-, DNase-, RNase-, human and bacterial DNA-free, amber (light protection), 200 tubes (4 bags × 50 tubes)

Forensic DNA Grade, colorless, 100 tubes, individually wrapped

sterile, pyrogen-, DNase-, RNase-, human and bacterial DNA-free, colorless, 500 tubes (20 racks × 25 tubes)

Eppendorf Conical Tubes, 50 mL

sterile, pyrogen-, DNase-, RNase-, human and bacterial DNA-free, colorless, 500 tubes (20 bags × 25 tubes)

sterile, pyrogen-, DNase-, RNase-, human and bacterial DNA-free, amber (light protection), 200 tubes (8 bags × 25 tubes)

Forensic DNA Grade, colorless, 48 tubes, individually wrapped

sterile, pyrogen-, DNase-, RNase-, human and bacterial DNA-free, colorless, 300 tubes (12 racks × 25 tubes)

Order no.

[0030122151](#)

[0030122194](#)

[0030122259](#)

[0030122160](#)

[0030122178](#)

[0030122224](#)

[0030122267](#)

[0030122186](#)



Eppendorf Conical Tubes SnapTec® 50

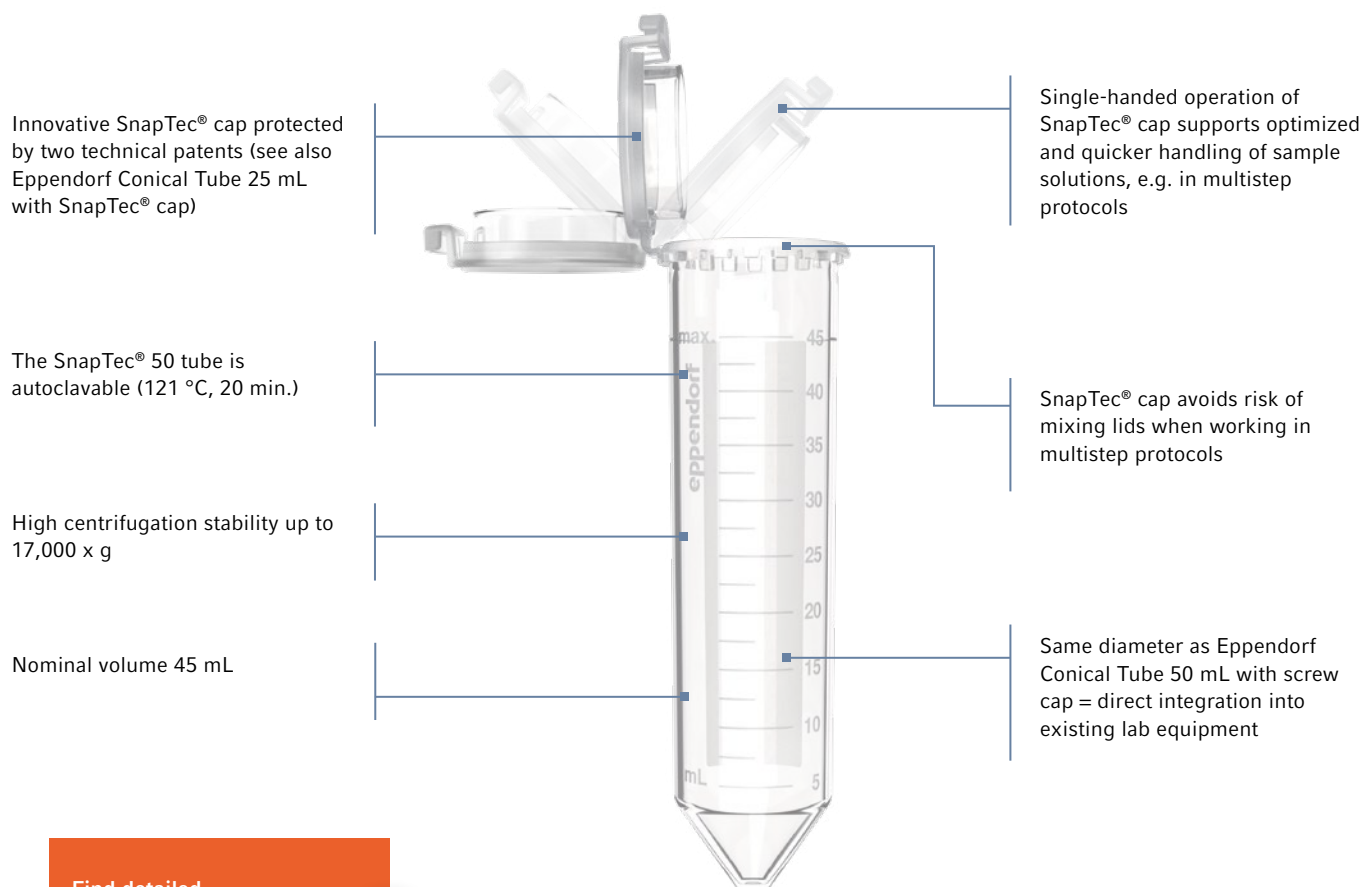

Find detailed information on SnapTec® patented lid technology



www.eppendorf.link/SnapTec50



Ordering information

Description

Eppendorf Conical Tubes SnapTec® 50, 45 mL

Eppendorf Quality, colorless, 240 tubes (8 bags × 30 tubes)

PCR clean, colorless, 240 tubes (8 bags × 30 tubes)

sterile, pyrogen-, DNase-, RNase-, human and bacterial DNA-free, colorless, 200 tubes (10 bags × 20 tubes)

Eppendorf Tube Rack, 12 positions, for 5.0 mL and 15 mL tubes, polypropylene, numbered positions, autoclavable, 2 pcs.

Eppendorf Tube Rack, 12 positions, 6 for 5.0 mL and 15 mL tubes and 6 for 25 mL and 50 mL tubes, polypropylene, numbered positions, autoclavable, 2 pcs.

Storage Box 5 × 5, freezer box, for 25 tubes 15 mL, 2 pcs., height 127 mm, 5 in, polypropylene, for freezing to -86 °C, autoclavable, with lid and alphanumeric code

Storage Box 3 × 3, freezer box, for 9 tubes 50 mL and 4 tubes 15 mL, 2 pcs., height 127 mm, 5 in, polypropylene, for freezing to -86 °C, autoclavable, with lid and alphanumeric code

Order no.

[0030118650](#)

[0030118669](#)

[0030118677](#)

[0030119827](#)

[0030119835](#)

[0030140583](#)

[0030140591](#)

Ordering information for DNA and Protein LoBind Tubes can be found at page 19



Your local distributor: www.eppendorf.link/contact

Eppendorf UK Limited · Gateway 1000 · Whittle Way · Stevenage SG1 2FP · United Kingdom · sales@eppendorf.co.uk · www.eppendorf.com · www.eppendorf.link/eshop



Eppendorf Tubes® BioBased

New

2nd Generation Feedstock, 1st Class Consumables

Minimal carbon footprint! No compromise on quality! The Eppendorf Tubes® BioBased meet the highest demands of diverse laboratory applications and convince by their sustainability which is achieved by producing these tubes from renewable feedstock of the second generation. General Quality Certificates on compliance with standards and general Eppendorf quality requirements,

product-specific and lot-specific purity certificates as well as ACT Certificates attest the well-known premium product quality customers can expect from Eppendorf Tubes. The sustainability factor of Eppendorf Tubes® BioBased will clearly be visible with continuous use in your laboratory carbon footprint. Eppendorf Tubes® BioBased are available with screw caps in volumes from 5.0 mL to 50 mL.



Product features

- > Support you in achieving your sustainability goals in the lab, reduce your lab carbon footprint! Produced from recycled feedstock in 2nd generation, derived solely from waste and residue streams from cooking oil production and used cooking oil
- > Traceability along the entire supply chain enabled through ISCC PLUS (International Sustainability & Carbon Certification)
- > ACT (Accountability, Consistency, and Transparency) Certification - the independent validation provided by My Green Lab®
- > Lot-specific purity certificates from an independent laboratory can be downloaded from Eppendorf website
- > General Quality Certificates on compliance with standards and general Eppendorf quality requirements
- > Ensured highest sample integrity by using premium USP class 6 raw material and no use of slip agents, plasticizers, and biocides during manufacturing

Applications

- > Convenient and safe cell culture applications
- > Sample preparation in microbiology and molecular biology labs
- > Storage of samples and solutions with larger volumes
- > Preparation of mastermixes and buffers



Download
Brochure

"2nd Generation Feedstock,
1st Class Consumables"
www.eppendorf.link/BioBased-Brochure



About Bio-based Polymer



To increase the sustainable properties of plastic used for the production of lab consumables, we must make and use plastics more sustainably using recycled and renewable feedstocks.

> In this specific bio-based polymer production, fossil raw material is saved by replacing it with sustainable raw material produced from bio-based waste and residues (2nd generation renewable feedstock)

- > The raw materials used to produce the renewable feedstock can be backtraced to the first collection points and the origin of the renewable raw materials from carefully selected suppliers committed to sustainability is assured
- > The final polymers are sustainability certified by "ISCC PLUS" - the reliable global leading certification scheme for manufacturers producing bio-based polymers and their further processing

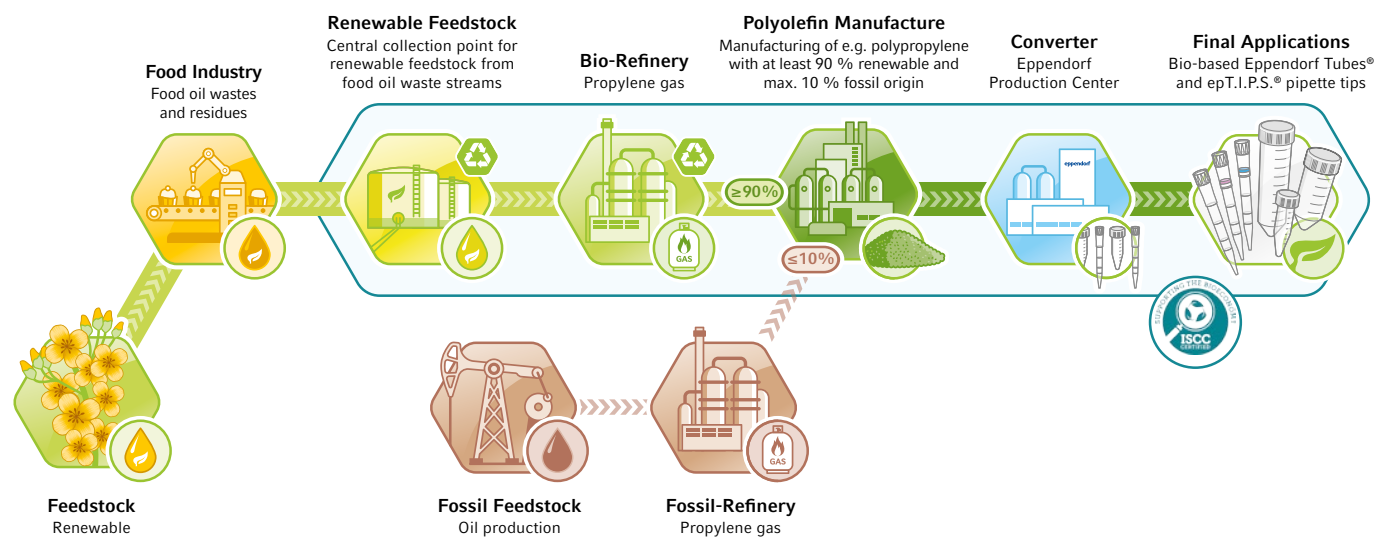

Ordering information

Description

Eppendorf Tubes® BioBased

screw cap, 15 mL, sterile, pyrogen-, DNase-, RNase-, human and bacterial DNA-free, colorless, 500 tubes (10 bags × 50 tubes)
screw cap, 25 mL, sterile, pyrogen-, DNase-, RNase-, human and bacterial DNA-free, colorless, 200 tubes (8 bags × 25 tubes)
screw cap, 50 mL, sterile, pyrogen-, DNase-, RNase-, human and bacterial DNA-free, colorless, 500 tubes (20 bags × 25 tubes)
screw cap, 5.0 mL, sterile, pyrogen-, DNase-, RNase-, human and bacterial DNA-free, colorless, 200 tubes (2 bags × 100 tubes)

Order no.

0030122526
0030122534
0030122542
0030122518





Protein LoBind® Tubes

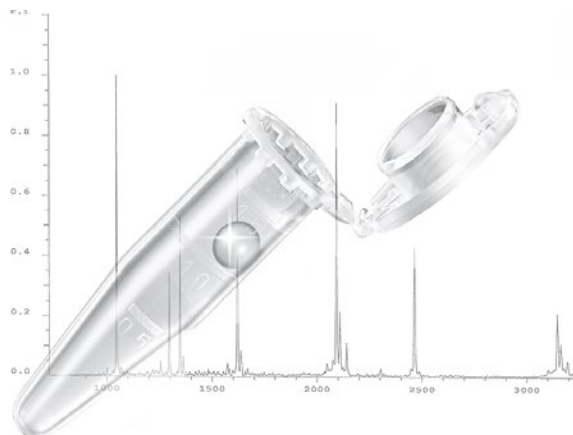
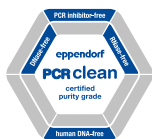

Optimal Sample Recovery!

Eppendorf Protein LoBind Tubes are specifically designed for use in proteomics or other fields of protein research, where protein concentration tends to be very small and sample recovery is vital for assay results. Significantly more protein can be recovered for downstream analyses, and enzymes remain active.

Product features

- > Eppendorf LoBind material ensures optimized sample recovery for improved assay results
- > Free of surface coating (e.g., silicone) to minimize the risk of sample interference
- > Lot-certified PCR clean purity grade: free of human DNA, DNase, RNase and PCR inhibitors

Ordering information

Description	Order no.
Protein LoBind® Tubes , screw cap, Protein LoBind®, 25 mL, PCR clean, colorless, 200 tubes (4 bags × 50 tubes)	0030122283
Protein LoBind® Tubes , SnapTec® cap, Protein LoBind®, 25 mL, PCR clean, colorless, 200 tubes (5 bags × 40 tubes)	0030108531
Protein LoBind® Tubes , snap cap, Protein LoBind®, 0.5 mL, PCR clean, colorless, 100 tubes (2 bags × 50 tubes)	0030108094
Protein LoBind® Tubes , snap cap, Protein LoBind®, 1.5 mL, PCR clean, colorless, 100 tubes (2 bags × 50 tubes)	0030108116
Protein LoBind® Tubes , snap cap, Protein LoBind®, 2.0 mL, PCR clean, colorless, 100 tubes (2 bags × 50 tubes)	0030108132
Protein LoBind® Tubes , snap cap, Protein LoBind®, 5.0 mL, PCR clean, colorless, 100 tubes (2 bags × 50 tubes)	0030108302
Protein LoBind® Tubes , screw cap, Protein LoBind®, 5.0 mL, PCR clean, colorless, 200 tubes (2 bags × 100 tubes)	0030122356
Protein LoBind® Tubes , screw cap, Protein LoBind®, 15 mL, conical tube, PCR clean, colorless, 200 tubes (4 bags × 50 tubes)	0030122216
Protein LoBind® Tubes , screw cap, Protein LoBind®, 50 mL, conical tube, PCR clean, colorless, 200 tubes (8 bags × 25 tubes)	0030122240

SafeCode Tubes and Plates



Discover our
solution



www.eppendorf.link/safecode

How often do you find samples difficult to identify on your lab bench?

More information about pre-coded tubes can be found in the “Freezer” chapter at page 22



DNA LoBind® Tubes

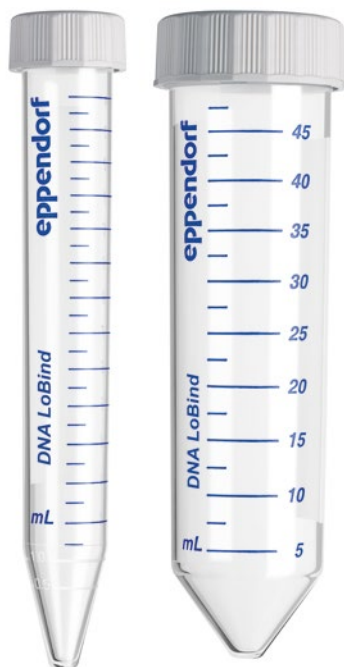

Improved Reproducibility!

DNA LoBind Tubes maximize sample recovery of nucleic acids by significantly reducing sample-to-surface binding. The ideal solution for sample preparation and long-term storage of your precious samples!

Product features

- > Eppendorf LoBind material ensures optimized sample recovery for improved assay results
- > Free of surface coating (e.g., silicone) to minimize the risk of sample interference
- > Lot-certified PCR clean purity grade: free of human DNA, DNase, RNase and PCR inhibitors

Ordering information

Description	Order no.
DNA LoBind® Tubes , screw cap, DNA LoBind®, 25 mL, PCR clean, colorless, 200 tubes (4 bags × 50 tubes)	0030122275
DNA LoBind® Tubes , SnapTec® cap, DNA LoBind®, 25 mL, conical tubes, PCR clean, colorless, 200 tubes (5 bags × 40 tubes)	0030108523
DNA LoBind® Tubes , snap cap, DNA LoBind®, 0.5 mL, PCR clean, colorless, 1 bag × 500 tubes	0030108400
DNA LoBind® Tubes , snap cap, DNA LoBind®, 1.5 mL, PCR clean, colorless, 1 bag × 500 tubes	0030108418
DNA LoBind® Tubes , snap cap, DNA LoBind®, 2.0 mL, PCR clean, colorless, 1 bag × 500 tubes	0030108426
DNA LoBind® Tubes , snap cap, DNA LoBind®, 0.5 mL, PCR clean, colorless, 250 tubes (5 bags × 50 tubes)	0030108035
DNA LoBind® Tubes , snap cap, DNA LoBind®, 1.5 mL, PCR clean, colorless, 250 tubes (5 bags × 50 tubes)	0030108051
DNA LoBind® Tubes , snap cap, DNA LoBind®, 2.0 mL, PCR clean, colorless, 250 tubes (5 bags × 50 tubes)	0030108078
DNA LoBind® Tubes , snap cap, DNA LoBind®, 5.0 mL, PCR clean, colorless, 200 tubes (4 bags × 50 tubes)	0030108310
DNA LoBind® Tubes , screw cap, DNA LoBind®, 5.0 mL, PCR clean, colorless, 200 tubes (2 bags × 100 tubes)	0030122348
DNA LoBind® Tubes , screw cap, DNA LoBind®, 15 mL, conical tubes, PCR clean, colorless, 200 tubes (4 bags × 50 tubes)	0030122208
DNA LoBind® Tubes , screw cap, DNA LoBind®, 50 mL, conical tubes, PCR clean, colorless, 200 tubes (8 bags × 25 tubes)	0030122232





Eppendorf Microplates

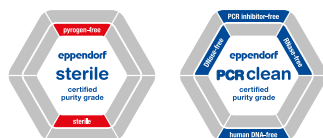
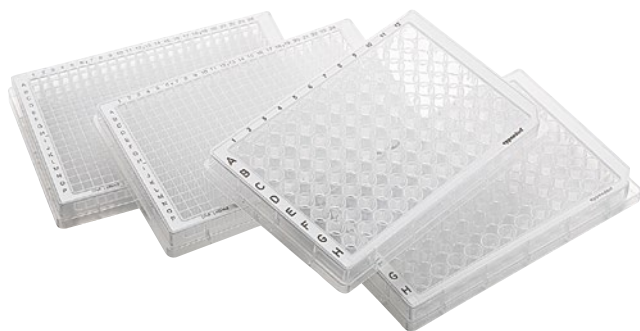





Get More!

Experience a new dimension of transparency - the Eppendorf Microplates! It has never been this easy and reliable to pipette, control and recover samples with a polypropylene microplate. We offer a wide variety of plates which are highly robust making it easy to find the optimal solution for your application needs. Also available as barcoded versions.

Product features

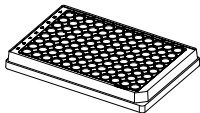
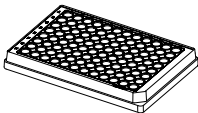
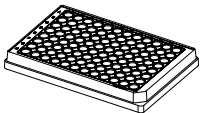
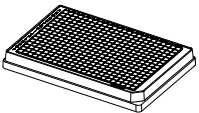
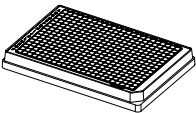
- > g-Safe®: exceptional centrifugation stability up to 6,000 × g
- > OptiTrack® Matrix: up to 30 % faster sample identification and fewer pipetting errors via high-contrast alphanumeric labeling
- > RecoverMax® well design: Optimized well geometry for minimal remaining volume and excellent mixing properties

Technical specifications

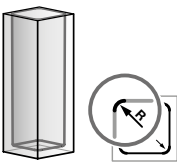
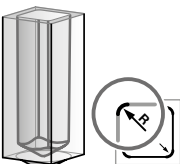
					
Description	Microplate 96/F	Microplate 96/U	Microplate 96/V	Microplate 384/F	Microplate 384/V-PP
Number of wells	96 wells	96 wells	96 wells	384 wells	384 wells
Working volume	50 – 350 µL	20 – 320 µL	20 – 320 µL	10 – 120 µL	5 – 120 µL
Total volume per well	400 µL	360 µL	350 µL	150 µL	140 µL
					
Bottom shape	F bottom	U bottom	V bottom	F bottom	conical

Ordering information

Description	Order no.
Microplate 96/F , wells clear, RecoverMax® well design	
PCR clean, white, 80 plates (5 bags × 16 plates)	0030601106
sterile, white, 80 plates (5 bags × 16 plates)	0030602102
Microplate 96/U , wells clear, RecoverMax® well design	
PCR clean, white, 80 plates (5 bags × 16 plates)	0030601203
sterile, white, 80 plates (5 bags × 16 plates)	0030602200
Microplate 96/V , wells clear, RecoverMax® well design	
PCR clean, white, 80 plates (5 bags × 16 plates)	0030601300
sterile, white, 80 plates (5 bags × 16 plates)	0030602307
Microplate 384/F , wells clear, RecoverMax® well design	
PCR clean, white, 80 plates (5 bags × 16 plates)	0030621107
sterile, white, 80 plates (5 bags × 16 plates)	0030622103
Microplate 384/V , wells clear, RecoverMax® well design	
PCR clean, white, 80 plates (5 bags × 16 plates)	0030621301
sterile, white, 80 plates (5 bags × 16 plates)	0030622308



Eppendorf Assay/Reader Microplates

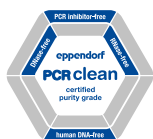

Unique Clarity!

Elevate the sensitivity of your assays with the Eppendorf Assay/Reader Plates to a higher level! The plates offer an excellent signal-to-noise ratio, resulting in an extremely low detection limit. Whether fluorescence or chemiluminescence - select the optimal plate for your assay! Solid plates are suitable for top-reading plates readers. Clear plates and black/clear plates can be used with top- and bottom-reading plates readers.

Product features

- > Black Eppendorf Microplates offer an excellent signal-to-noise ratio – for clear signals even with low-concentration samples
- > White Eppendorf Microplates are optimized for highest sensitivity in the detection of luminescence signals by maximizing reflection
- > Solid black and white assay plates are made of polypropylene resulting in high resistance to chemicals, mechanical stress, and temperature extremes

Ordering information

Description	Order no.
Microplate 96/F , wells white	
PCR clean, gray, 80 plates (5 bags × 16 plates)	0030601475
Microplate 96/U , wells white	
PCR clean, gray, 80 plates (5 bags × 16 plates)	0030601572
Microplate 96/V , wells white	
PCR clean, gray, 80 plates (5 bags × 16 plates)	0030601670
Microplate 384/V , wells white	
PCR clean, gray, 80 plates (5 bags × 16 plates)	0030621670
Microplate 96/F , wells black	
PCR clean, white, 80 plates (5 bags × 16 plates)	0030601700
Microplate 96/U , wells black	
PCR clean, white, 80 plates (5 bags × 16 plates)	0030601807
Microplate 96/V , wells black	
PCR clean, white, 80 plates (5 bags × 16 plates)	0030601904
Microplate 384/V , wells black	
PCR clean, white, 80 plates (5 bags × 16 plates)	0030621905





Eppendorf Deepwell Plates



Precision and Accuracy!

Eppendorf Deepwell Plates 96 and 384 are high performance plates fulfilling highest requirements of all manual and automated applications. They combine innovative features, like the OptiTrack® matrix, with thoroughgoing quality for which Eppendorf consumables are globally known as a premium standard. Also available as barcoded versions.

Product features

- > OptiTrack® matrix: up to 30 % faster sample identification and fewer pipetting errors via high-contrast alphanumeric labeling
- > RecoverMax® well design: Optimized well geometry for maximum sample recovery and excellent mixing properties
- > g-Safe®: exceptional centrifugation stability up to 6,000 x g for faster protocols and improved sample quality

Ordering information

Description	Order no.
Deepwell Plate 96/500 µL , wells clear, 500 µL	
PCR clean, white, 40 plates (5 bags × 8 plates)	0030501101
PCR clean, yellow, 40 plates (5 bags × 8 plates)	0030501110
PCR clean, green, 40 plates (5 bags × 8 plates)	0030501136
PCR clean, blue, 40 plates (5 bags × 8 plates)	0030501144
PCR clean, white, 120 plates (10 bags × 12 plates)	0030505107
sterile, white, 40 plates (5 bags × 8 plates)	0030502108
sterile, yellow, 40 plates (5 bags × 8 plates)	0030502116
sterile, green, 40 plates (5 bags × 8 plates)	0030502132
sterile, blue, 40 plates (5 bags × 8 plates)	0030502140
sterile, white, 120 plates (10 bags × 12 plates)	0030506103
Deepwell Plate 96/1000 µL , wells clear, 1,000 µL	
PCR clean, white, 20 plates (5 bags × 4 plates)	0030501209
PCR clean, yellow, 20 plates (5 bags × 4 plates)	0030501217
PCR clean, green, 20 plates (5 bags × 4 plates)	0030501233
PCR clean, blue, 20 plates (5 bags × 4 plates)	0030501241
PCR clean, white, 80 plates (10 bags × 8 plates)	0030505204
sterile, white, 20 plates (5 bags × 4 plates)	0030502205
sterile, yellow, 20 plates (5 bags × 4 plates)	0030502213
sterile, green, 20 plates (5 bags × 4 plates)	0030502230
sterile, blue, 20 plates (5 bags × 4 plates)	0030502248
sterile, white, 80 plates (10 bags × 8 plates)	0030506200
Deepwell Plate 96/2000 µL , wells clear, 2,000 µL	
PCR clean, white, 20 plates (5 bags × 4 plates)	0030501306
PCR clean, yellow, 20 plates (5 bags × 4 plates)	0030501314
PCR clean, green, 20 plates (5 bags × 4 plates)	0030501330
PCR clean, blue, 20 plates (5 bags × 4 plates)	0030501349
PCR clean, white, 80 plates (10 bags × 8 plates)	0030505301
sterile, white, 20 plates (5 bags × 4 plates)	0030502302
sterile, yellow, 20 plates (5 bags × 4 plates)	0030502310
sterile, green, 20 plates (5 bags × 4 plates)	0030502337
sterile, blue, 20 plates (5 bags × 4 plates)	0030502345
sterile, white, 80 plates (10 bags × 8 plates)	0030506308
Deepwell Plate 384/200 µL , wells clear, 200 µL	
PCR clean, white, 40 plates (5 bags × 8 plates)	0030521102
sterile, white, 40 plates (5 bags × 8 plates)	0030522109
PCR clean, white, 120 plates (10 bags × 12 plates)	0030525108
sterile, white, 120 plates (10 bags × 12 plates)	0030526104



Protein LoBind® Plates

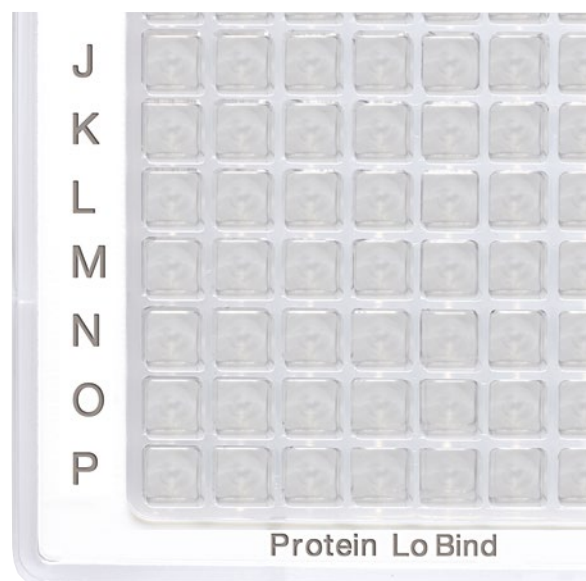

Optimized Sample Recovery!

Eppendorf Protein LoBind Plates are specifically designed for use in proteomics or other fields of protein research, where protein concentration tend to be very small and sample recovery is vital for assay results. Significantly more protein can be recovered for downstream analysis and enzymes remain active. Also available as barcoded versions.

Product features

- > Eppendorf LoBind material ensures excellent sample recovery for improved assay results
- > Free of surface coating (e.g., silicone) to minimize the risk of sample interference
- > Lot-certified PCR clean purity grade: free of human DNA, DNase, RNase and PCR inhibitors

Ordering information

Description	Order no.
Deepwell Plate 96/500 µL , Protein LoBind®, wells colorless, 500 µL	
PCR clean, white, 40 plates (5 bags × 8 plates)	0030504100
PCR clean, yellow, 40 plates (5 bags × 8 plates)	0030504119
PCR clean, white, 120 plates (10 bags × 12 plates)	0030508106
Deepwell Plate 96/1000 µL , Protein LoBind®, wells colorless, 1,000 µL	
PCR clean, white, 20 plates (5 bags × 4 plates)	0030504208
PCR clean, yellow, 20 plates (5 bags × 4 plates)	0030504216
PCR clean, white, 80 plates (10 bags × 8 plates)	0030508203
Deepwell Plate 96/2000 µL , Protein LoBind®, wells colorless, 2,000 µL	
PCR clean, white, 20 plates (5 bags × 4 plates)	0030504305
Deepwell Plate 384/200µL , Protein LoBind®, wells colorless, 200 µL	
PCR clean, white, 40 plates (5 bags × 8 plates)	0030524101
PCR clean, white, 120 plates (10 bags × 12 plates)	0030528107
Microplate 384/V-PP , Protein LoBind®, wells clear, 140 µL	
PCR clean, white, 80 plates (5 bags × 16 plates)	0030624300
PCR clean, white, 240 plates (10 bags × 24 plates)	0030628306





DNA LoBind® Plates



Improved Reproducibility!

DNA LoBind Plates maximize sample recovery of nucleic acids by significantly reducing sample-to-surface binding. The ideal solution for sample preparation and long-term storage of your precious samples! Also available as barcoded versions.

Product features

- > Eppendorf LoBind material ensures optimized sample recovery for improved assay results
- > Free of surface coating (e.g. silicone) to minimize the risk of sample interference
- > Lot-certified PCR clean purity grade: free of human DNA, DNase, RNase and PCR inhibitors



How it works



www.eppendorf.link/purity-video

Ordering information

Description	Order no.
Deepwell Plate 96/500µL , DNA LoBind®, wells clear, 500 µL, LoBind®	
PCR clean, white, 40 plates (5 bags × 8 plates)	0030503104
PCR clean, blue, 40 plates (5 bags × 8 plates)	0030503147
PCR clean, white, 120 plates (10 bags × 12 plates)	0030507100
Deepwell Plate 96/1000µL , DNA LoBind®, wells clear, 1,000 µL, LoBind®	
PCR clean, white, 20 plates (5 bags × 4 plates)	0030503201
PCR clean, blue, 20 plates (5 bags × 4 plates)	0030503244
PCR clean, white, 80 plates (10 bags × 8 plates)	0030507207
Deepwell Plate 384/200µL , DNA LoBind®, wells clear, 200 µL, LoBind®	
PCR clean, white, 40 plates (5 bags × 8 plates)	0030523105
PCR clean, white, 120 plates (10 bags × 12 plates)	0030527100
Microplate 96/V-PP , DNA LoBind®, wells clear, 350 µL, LoBind®	
PCR clean, white, 80 plates (5 bags × 16 plates)	0030603303
Microplate 384/V-PP , DNA LoBind®, wells clear, 140 µL, LoBind®	
PCR clean, white, 80 plates (5 bags × 16 plates)	0030623304
PCR clean, white, 240 plates (10 bags × 24 plates)	0030627300



Plate Accessories

Sealing options for Sample Preparation and Storage

- > Sealing Mats are reusable and can be autoclave. Sealing mats are suitable for short-term storage
- > Heat Sealing Film and Foil for continuous locking with the best evaporation protection
- > Foil products are made of aluminum, can be pierced, and protect light-sensitive samples



Ordering information

Description	Order no.
Eppendorf Storage Film , self-adhesive, PCR clean, 100 pcs. (2 bags × 50 pcs.)	0030127870
Eppendorf Storage Foil , self-adhesive, PCR clean, 100 pcs.	0030127889
Eppendorf Sealing Mat , for DWP 96/2000, PCR clean, 50 pcs. (5 bags × 10 pcs.)	0030127960
Eppendorf Sealing Mat , for DWP 96/1000 and DWP 96/500, PCR clean, 50 pcs. (5 bags × 10 pcs.)	0030127978
Eppendorf Plates® Lid , for MTP and DWP, PCR clean, 80 pcs. (5 bags × 16 pcs.)	0030131517
Eppendorf Plates® Lid , for MTP and DWP, sterile, 80 pcs. (5 bags × 16 pcs.)	0030131525
Eppendorf Heat Sealing Film , PCR clean, 100 pcs.	0030127838
Eppendorf Heat Sealing Foil , PCR clean, 100 pcs.	0030127854

Eppendorf Tube and Cuvette Racks

- > Made from high quality polypropylene (PP):
 - > Ensuring dimensional stability across a broad temperature range (-86° C to 121° C)
 - > Providing chemical resistance
- > The racks are UV-light resistant
- > Six different formats always offer the optimal choice for all common tubes and cuvettes



Ordering information

Description	Order no.
Eppendorf Tube Rack , 48 positions, for 0.5 mL tubes, polypropylene, numbered positions, autoclavable, 2 pcs.	0030119800
Eppendorf Tube Rack , 12 positions, for 5.0 mL and 15 mL tubes, polypropylene, numbered positions, autoclavable, 2 pcs.	0030119827
Eppendorf Tube Rack , 12 positions, 6 for 5.0 mL and 15 mL tubes and 6 for 25 mL and 50 mL tubes, polypropylene, numbered positions, autoclavable, 2 pcs.	0030119835
Eppendorf Cuvette Rack , 30 positions, for glass and plastic cuvettes, polypropylene, numbered positions, autoclavable, 2 pcs.	0030119851
Eppendorf Tube Rack , 36 positions, for cryogenic tubes, polypropylene, numbered positions, autoclavable, 2 pcs.	0030119843
Eppendorf Tube Rack , 36 positions, for 1.5 mL and 2.0 mL tubes, polypropylene, numbered positions, autoclavable, 2 pcs.	0030119819



Tubes and Plates

Tubes and Cuvettes Accessories

Micropestle

- > Two sides for optimal fit in 1.5 mL and 2.0 mL vessels
- > Autoclavable (121 °C, 20 min)



Ordering information

Description	Order no.
Micropestle , for resuspending pellets in 1.5/2.0 mL vessels, 10 pcs.	0030120973

Eppendorf Storage Boxes

- > Made of polypropylene (PP) for high stability in freezing applications and smooth opening and closing
- > For freezing to -86 °C
- > High-contrast permanent alphanumeric marking of each location through laser labeling enables easy sample identification and minimizes risk of sample mix-up



Ordering information

Description	Order no.
Storage Box 10 × 10 , freezer box, for 100 cryogenic tubes w. int. thread, 3 pcs., height 53 mm, 2 in, polypropylene, for freezing to -86 °C, autoclavable, with lid and alphanumeric code	0030140508
Storage Box 9 × 9 , freezer box, for 81 screw cap (cryog.) tubes 1 – 2 mL, 3 pcs., height 53 mm, 2 in, polypropylene, for freezing to -86 °C, autoclavable, with lid and alphanumeric code	0030140516
Storage Box 9 × 9 , freezer box, for 81 screw cap (cryog.) tubes 3 mL, 2 pcs., height 76 mm, 3 in, polypropylene, for freezing to -86 °C, autoclavable, with lid and alphanumeric code	0030140540
Storage Box 9 × 9 , freezer box, for 81 screw cap (cryog.) tubes 4 – 5 mL, 2 pcs., height 102 mm, 4 in, polypropylene, for freezing to -86 °C, autoclavable, with lid and alphanumeric code	0030140567
Storage Box 8 × 8 , freezer box, for 64 tubes 1 – 2 mL, 3 pcs., height 53 mm, 2 in, polypropylene, for freezing to -86 °C, autoclavable, with lid and alphanumeric code	0030140524
Storage Box 5 × 5 , freezer box, for 25 tubes 5 mL, 4 pcs., height 64 mm, 2.5 in, polypropylene, for freezing to -86 °C, autoclavable, with lid and alphanumeric code	0030140532
Storage Box 5 × 5 , freezer box, for 25 tubes 5 mL screw cap, 2 pcs., height 76 mm, 3 in, polypropylene, for freezing to -86 °C, autoclavable, with lid and alphanumeric code	0030140613
Storage Box 5 × 5 , freezer box, for 25 tubes 15 mL, 2 pcs., height 127 mm, 5 in, polypropylene, for freezing to -86 °C, autoclavable, with lid and alphanumeric code	0030140583
Storage Box 3 × 3 , freezer box, for 9 tubes 25 mL, 2 pcs., height 89 mm, 3.5 in, polypropylene, for freezing to -86 °C, autoclavable, with lid and alphanumeric code	0030140729
Storage Box 3 × 3 , freezer box, for 9 tubes 50 mL and 4 tubes 15 mL, 2 pcs., height 127 mm, 5 in, polypropylene, for freezing to -86 °C, autoclavable, with lid and alphanumeric code	0030140591

Our Portfolio – Your Choice

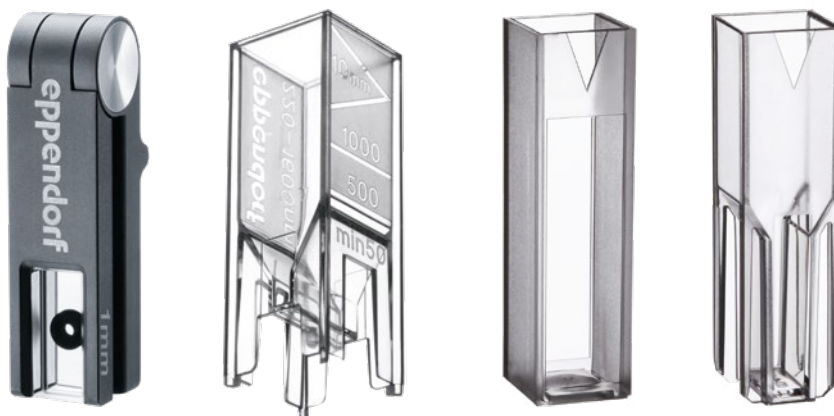

Model	Eppendorf µCuvette® G1.0	Eppendorf UVette®	Macro Vis Cuvette	Semi-micro Vis Cuvette
Page(s)	28	28	29	29
dsDNA concentration range (UV 260 nm)	25 ng/µL – 1,500 ng/µL	2.5 ng/µL – 750 ng/µL	1 pg/µL 1,000 pg/µL (Pico Green Assay)	1 pg/µL 1,000 pg/µL (Pico Green Assay)
BSA concentration range (UV 280 nm)	758 ng/µL – 45,450 ng/µL	76 ng/µL – 22,725 ng/µL	0.01 ng/µL – 0.01 µg/µL (NanoOrange Assay)	0.01 ng/µL – 0.01 µg/µL (NanoOrange Assay)
Colorimetric protein assays	yes	yes	yes	yes
OD 600 methods	no	yes	yes	yes
Fluorescence measurements	yes	yes	yes	yes
UV transparency	>180 nm	>220 nm	–	–
Light transmission	180 nm – 2,000 nm	220 nm – 1,600 nm	300 nm – 900 nm	300 nm – 900 nm
Material	quartz glass (with hydrophobic coating)	UV-transparent plastic	PMMA	PMMA
Dimensions (W × D × H)	12.5 × 12.5 × 48 mm	12.5 × 12.5 × 36 mm / 0.49 × 0.49 × 1.42 in	12.5 × 12.5 × 45 mm	12.5 × 12.5 × 45 mm
Temperature control	no	no	yes	no
Minimum filling volume				
in Eppendorf photometers	1.5 µL	50 µL	1,000 µL	400 µL
in devices of other manufacturers	–	50 µL	2,500 µL	1,500 µL
Maximum filling volume	10 µL	2,000 µL	4,500 µL	3,000 µL
Sample light path length	1 mm	2 mm and 10 mm	10 mm	10 mm
Cuvette blank	≤0.05 A at 260 nm	≤0.5 A at 260 nm	–	–
Height of light source	8.5 mm	8.5 mm ¹⁾	all common cell heights	all common cell heights
Use in Eppendorf BioPhotometer®	yes	yes	yes	yes
Use in Eppendorf BioSpectrometer®	yes	yes	yes	yes
Use in devices of other manufacturers	no	yes (adapters available)	yes	yes

¹⁾ adapters available for height adjustment

Get all information about the Eppendorf detection portfolio!
Explore the eshop and get an overview!

www.eppendorf.link/detection





Eppendorf μ Cuvette[®] G1.0

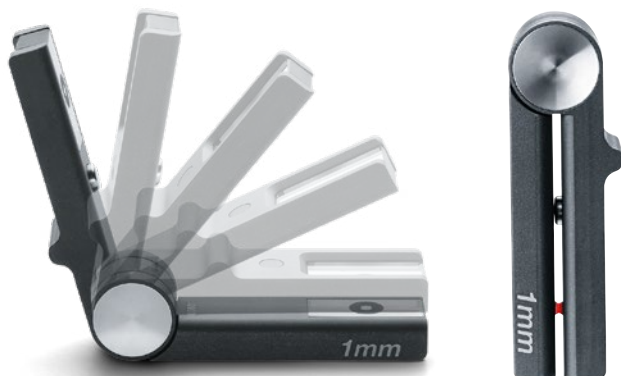

One droplet is the limit?

The μ Cuvette G1.0 is in your range: Only 1.5 μ L of a sample is needed. The optical path length of only 1 mm enables a light path that is 10x shorter than the light path on standard cuvettes: Measure high nucleic acid and protein concentrations.

Product features

- > Microvolume measuring cell for measuring 1.5 – 10 μ L sample volumes
- > Concentration determination of nucleic acids and proteins, amongst other target analytes
- > Measurement of highly concentrated samples without prior dilution

Ordering information

Description

Eppendorf μ Cuvette[®] G1.0, Microvolume measuring cell for Eppendorf BioPhotometer[®] and BioSpectrometer[®]

Order no.

[613800018](#)

Eppendorf UVette[®]



Working with very low amount of samples?

The UVette is a disposable UV/Vis cuvette with a light transmission of 220 nm to 1,600 nm for spectrophotometer and photometers. As an example of Eppendorf's expertise in the production of high quality consumables, the UVette offers superb purity, convenience and precision for photometric analysis. The unique shape of the UVette combines two optical light path lengths to offer greater flexibility.

Product features

- > Suitable for measuring small volumes ($\geq 50 \mu$ L)
- > UV and Vis measurements from 220 nm to 1,600 nm
- > UV transparent plastic, free of fluoropolymers and other halogenated hydrocarbons

Ordering information

Description

UVette[®] 220 nm – 1,600 nm, original Eppendorf plastic cuvette, individually packed, (including RNase-free, DNase-free) and protein-free, PCR clean, 50 – 2,000 μ L, 80 pcs.

Order no.

[0030106300](#)

UVette[®] starter set, 80 UVettes and 1 universal adapter for light path height 15 mm, convertible to 8.5 mm, 50 – 2,000 μ L

[4099100007](#)

UVette[®] routine pack 220 nm – 1,600 nm, reclosable box, Eppendorf Quality, 50 – 2,000 μ L, 200 pcs.

[0030106318](#)

Adapter for UVette[®], for photometer/spectrophotometer with light path height

8.5 mm

[4099001009](#)

10 mm

[4099002005](#)

15 mm

[4099003001](#)

20 mm

[4099005004](#)

Eppendorf Cuvette Rack, 30 positions, for glass and plastic cuvettes, polypropylene, numbered positions, autoclavable, 2 pcs.

[0030119851](#)



Eppendorf Vis Cuvettes



Optimal Clarity!

The Eppendorf Vis Cuvettes are disposable cuvettes made of clear plastic with a light transmission of 300 nm to 900 nm. These cuvettes are perfect for applications outside of the UV range, such as colorimetric protein assays (Bradford, Lowry, etc.), determining of the optical density of bacterial cultures (OD600 methods), and kinetic and fluorescence measurements.

Product features

- > Two different cuvette sizes (semi-micro and macro) for a wide variety of volumes and applications
- > Disposable cuvettes made of clear plastic with a light transmission of 300 nm to 900 nm

Ordering information

Description	Order no.
Eppendorf macro Vis Cuvette , plastic cuvette for measurements in the Vis range, max. filling volume 4,500 μL 1,000 cuvettes (10 boxes \times 100 cuvettes)	0030079345
Eppendorf semi-micro Vis Cuvette , plastic cuvette for measurements in the Vis range max. filling volume 3,000 μL	0030079353
Eppendorf Cuvette Rack , 30 positions, for glass and plastic cuvettes, polypropylene, numbered positions, autoclavable, 2 pcs.	0030119851



Centrifuges and Rotors



We introduced our very first centrifuge in 1964 as an integral part of the Eppendorf Microliter System, and revolutionized life science research practices worldwide. To this day, the Eppendorf name remains synonymous with creative design, innovative technology and reliable performance that stand the test of time.

The Eppendorf approach to product development is about listening to our customers' needs, understanding daily laboratory routines and anticipating future trends. The result is a comprehensive line of centrifuges that fulfill the demands for a wide range of applications. Our goal is to provide you with a product solution that not only leaves you thoroughly satisfied but that is also comfortable and easy to use. That is why Eppendorf centrifuges are designed to go beyond speed and capacity to offer you unparalleled ergonomic operation and superior temperature management. With this sound foundation and our extensive experience, Eppendorf is proud to serve you as your expert partner in centrifugation.

Our Centrifuge Portfolio – Your Centrifuge Solution

From your personal 12-place microcentrifuge to compact and super-versatile benchtop centrifuges to high-speed and ultracentrifuges, our portfolio offers comprehensive solutions for all your separation applications in the areas of molecular biology, biochemistry, cell biology and material science.

Microcentrifuges



General purpose centrifuges



Multipurpose centrifuges



Whether you wish to spin just a few tubes at a time or you require extra versatility for volumes up to four liters or high-throughput of tubes and plates, the Eppendorf benchtop centrifuge portfolio offers solutions for your daily separation tasks.

Looking to process more than four liters per run? Do you need increased speeds up to 110,000 x g? In either case, you will find our high-speed floorstanding centrifuges are your best choice. For super-speed applications requiring up to 1,050,000 x g, our range of innovative and user-friendly ultracentrifuges provide the perfect solution.

High-Speed centrifuges



Ultracentrifuges



Your challenges are multidimensional – so are our offerings

In your daily research work, you will encounter a variety of challenges. That's why we continuously work to understand your unique issues and provide you with tailored solutions to suit your needs, so you can spend more time focusing on your research. Our solutions go beyond the centrifuge itself to provide everything you need to ensure the best performance and best results every day.

CENTRIFUGES

Our high-quality devices offer innovative features to optimize your experience and your results.

SUSTAINABILITY

Sustainable production, energy-saving operation and an innovative cooling system are just some of the ways Eppendorf supports the environment.

SERVICE

Enjoy peace-of-mind and maximize your uptime with your choice of Eppendorf Services.

ROTORS & ADAPTERS

A great variety of accessories ensure application flexibility – for your separation tasks of today and tomorrow.

CONSUMABLES

Protect your valuable samples by using only the best consumables tailored to your needs in format, size and purity grades.

DIGITAL PRODUCTS

Get everything you need for a connected and paper-free lab of the future.



With Eppendorf at your side, you can be sure to have excellent equipment as well as a great team to support you. From our trusted sales representatives to our dedicated applications and technical support teams to our highly skilled service technicians – you will always find a helping hand when you need it.

Learn more about the Eppendorf centrifuge portfolio!

Explore the eshop and get an overview!

www.eppendorf.link/centrifugation



Our Portfolio – Your Choice



Model	MiniSpin®/MiniSpin® plus	5418 R	5420
Positioning	Space-saving 12-place mini-centrifuge for quick spin downs even in the smallest workstation, non-refrigerated	Compact refrigerated 18-place microcentrifuge for temperature sensitive samples	Small footprint 24-place microcentrifuge for molecular biology routine applications, non-refrigerated
Page(s)	10	11	12
Max. capacity	12 × 1.5/2.0 mL	18 × 1.5/2.0 mL	24 × 1.5/2.0 mL
Max. RCF	12,100 × g/14,100 × g	16,873 × g	21,300 × g
Max. speed	13,400 rpm/14,500 rpm	14,000 rpm	15,060 rpm
Rotors available	2	1	2
Temperature control range		0 °C to +40 °C	
Dimensions (W × D × H)	22.5 × 23.0 × 13.0 cm / 8.86 × 9.06 × 5.12 in	30 × 46 × 25 cm / 11.7 × 18.23 × 9.8 in	24 × 35 × 22 cm / 9.4 × 13.8 × 8.7 in
Weight w/o accessories	3.7 kg / 8.16 lb/4.1 kg / 9 lb	22 kg / 48.5 lb	13 kg / 28.7 lb
Max. power consumption	70 W/85 W	320 W	290 W
Noise level	< 49 dB(A)/< 52 dB(A)	< 57 dB(A)	< 56 dB(A)
Height (with open lid)	25 cm / 9.8 in	52 cm / 20 in	44 cm / 17.3 in
Display	LCD	large LCD	large, brightly lit LCD
Tube/plate/bottle capacity			
1.5/2.0 mL Eppendorf Tubes®	12	18	24
Eppendorf Tubes® 5.0 mL	–	–	–
8-place PCR strips	2	–	4
15 mL conical tubes	–	–	–
25 mL conical tubes	–	–	–
50 mL conical tubes	–	–	–
13 mm round-bottom and blood collection tubes	–	–	–
16 mm round-bottom and blood collection tubes	–	–	–
17.5 mm round-bottom and blood collection tubes	–	–	–
PCR plates/MTP	–	–	–
Deepwell plates (DWP)	–	–	–

Learn more about the Eppendorf microcentrifuge portfolio!

Explore the eshop and get an overview!

www.eppendorf.link/microcentrifuges



Centrifuges and Rotors

**5425 / 5425 R**

Whisper quiet 24-place standard microcentrifuge with outstanding feature set for broad range of applications, refrigerated for temperature-sensitive samples or non-refrigerated

13

10 × 5.0 mL

21,300 × g

15,060 rpm

6

-10 °C to +40 °C

24 × 39 × 24 cm / 9.5 × 15.4 × 9.5 in /

29 × 48 × 26 cm / 11.42 × 18.9 × 10.24 in

15.6 kg / 34.4 lb / 21.0 kg / 46.3 lb

280 W / 360 W

average of 45 dB(A) in the first 12 minutes and

< 51 dB(A) thereafter with Rotor FA-24x2 /

< 54 dB(A) for all other rotors

48 cm / 18.8 in / 50.8 cm / 20.0 in

large, brightly lit LCD

24

10

12

-

-

-

-

-

-

-

1 (divisible)

-

5427 R

High-throughput 48-place microcentrifuge, refrigerated (green cooling liquid (R290)) for temperature sensitive samples

15

48 × 1.5/2.0 mL

25,001 × g

16,220 rpm

9

-11 °C to 40 °C

31.9 × 54.0 × 25.4 cm / 12.6 × 21.3 × 10 in

30 kg / 66.1 lb

495 W

< 55 dB(A) with rotor FA-45-48-11

56 cm / 21.9 in

large, brightly lit LCD

48

12

6

-

-

-

-

-

-

-

-

5430 / 5430 R

Crossover microcentrifuge with high versatility and 12 rotor options including rotor for 15/50 mL conical tubes, 30-place high-speed rotor and swing-bucket rotor for MTPs or DWPs, refrigerated for temperature sensitive samples or non-refrigerated

17

48 × 1.5/2.0 mL, 6 × 50 mL, 2 × MTP

30,130 × g

17,500 rpm

12

-11 °C to 40 °C

34 × 42 × 25 cm / 11.2 × 16.3 × 9.8 in /

38 × 64 × 29 cm / 15 × 25.2 × 11.7 in

29 kg / 63.9 lb / 56 kg / 123.5 lb

475 W / 1,050 W

< 58 dB(A) with Rotor F-45-30-11 /

< 54 dB(A) with Rotor F-45-30-11

56 cm / 21.8 in / 63 cm / 24.8 in

large, brightly lit LCD

48

16

8

6

6

6

12

12

12

2

2

Our Portfolio – Your Choice



Model	5702 / 5702 R / 5702 RH	5804 / 5804 R
Positioning	General purpose centrifuge with medium capacity for low speed cell culture applications, refrigerated for temperature sensitive samples, active heating and cooling to improve cell viability or non-refrigerated	High speed multipurpose centrifuge with medium capacity, refrigerated for temperature sensitive samples or non-refrigerated
Page(s)	20	24
Max. capacity	4 × 100 mL	4 × 250 mL/2 × 5 MTP
Max. RCF	3,000 × g	20,913 × g
Max. speed	4,400 rpm	14,000 rpm
Temperature control range	-9 °C to 40 °C / -9 °C to 42 °C	-9 °C to 40 °C
Dimensions (W × D × H)	32 × 40 × 24 cm / 12.6 × 15.6 × 9.6 in / 38 × 58 × 27 cm / 15 × 22.9 × 10.6 in / 38 × 58 × 27 cm / 15 × 22.9 × 10.6 in	46.6 × 55.0 × 33.7 cm / 18.4 × 21.7 × 13.3 in / 63.4 × 55.0 × 34.2 cm / 25.0 × 21.7 × 13.5 in
Footprint (dimensions w/o front panel, WxD)	32 × 40 cm / 12.6 × 15.6 in / 38 × 58 cm / 15 × 22.9 in	47 × 50 cm / 18.4 × 21.7 in / 64 × 50 cm / 25 × 21.7 in
Weight w/o accessories	19 kg / 41.9 lb / 35 kg / 77.1 lb / 35 kg / 77.1 lb	55 kg / 121.3 lb / 80 kg / 176.4 lb
Max. power consumption	200 W / 380 W / 380 W	900 W / 1,650 W
Noise level	< 52 dB(A) with Rotor A-4-38 / <46 dB(A) with Rotor A-4-38 / <46 dB(A) with Rotor A-4-38	< 62 dB(A) / < 58 dB(A)
Height (with open lid)	53 cm / 20.7 in / 60 cm / 23.4 in / 60 cm / 23.4 in	74 cm / 29 in
Display	LCD	large, brightly lit LCD
Tube/plate/bottle capacity		
1.5/2.0 mL Eppendorf Tubes®	24	104
Eppendorf Tubes® 5.0 mL	4	32
8-place PCR strips	–	6
15 mL conical tubes	20	40
25 mL conical tubes	4	16
50 mL conical tubes	4	16
13 mm round-bottom and blood collection tubes	40	56
16 mm round-bottom and blood collection tubes	16	52
17.5 mm round-bottom and blood collection tubes	24	48
180 – 250 mL bottles (flat)	–	4
500 mL Corning®	–	–
750 mL bottles	–	–
1,000 mL Eppendorf bottles	–	–
1,000 mL standard bottles	–	–
PCR plates/MTP	–	10
Deepwell plates (DWP)	–	4

Learn more about the Eppendorf multipurpose centrifuge portfolio!

Explore the eshop and get an overview!

www.eppendorf.link/multipurpose-centrifuge



Centrifuges and Rotors

**5810 / 5810 R**

Compact multipurpose centrifuge with medium capacity, refrigerated for temperature sensitive samples or non-refrigerated

24

4 x 750 mL/4 x 4 MTP

20,913 x g

14,000 rpm

-9 °C to 40 °C

53.5 x 60.8 x 34.5 cm / 21.1 x 23.9 x 13.6 in /

70.0 x 60.8 x 34.5 cm / 27.6 x 23.9 x 13.6 in

54 x 54 cm / 21.1 x 21.1 in /

70 x 54 cm / 27.6 x 21.1 in

68 kg / 149.9 lb / 99 kg / 218.3 lb

900 W / 1,650 W

<70 dB(A) / <56 dB(A)

80 cm / 31.5 in

large, brightly lit LCD

200

56

6

56

32

28

100

80

80

4

4

4

-

-

16

4

5910 Ri

Super versatile multipurpose centrifuge with an intuitive touch screen user interface and high capacity for a broad range of consumables, refrigerated for temperature sensitive samples

44

68 x 15 mL/36 x 50 mL/4 x 1000 mL/ 4 x 5 MTP

22,132 x g

14,000 rpm

-11 °C to 40 °C

72 x 68 x 37 cm / 28.3 x 25.9 x 14.5 in

72 x 62 cm / 28.3 x 24.4 in

109 kg / 240.3 lb

1,650 W

<59 dB(A) with Rotor FA-6x50

85 cm / 33.5 in

VisioNize® touch interface

200

68

-

68

36

36

120

104

84

6

4

4

4

-

-

20

8

5920 R

High-throughput multipurpose centrifuge with very high capacity, refrigerated for temperature sensitive samples

44

4 x 1,000 mL/4 x 7 MTP

21,194 x g

13,700 rpm

-11 °C to 40 °C

74 x 71 x 40 cm / 29.2 x 27.8 x 15.9 in

74 x 67 cm / 29.2 x 26.4 in

139 kg / 286.6 lb

1,650 W

<55 dB(A)

94 cm / 37 in

large, brightly lit LCD

368

108

-

108

52

52

196

148

80

8

4

4

-

4

28

8

Our Portfolio – Your Choice



Model	CR22N	CR30NX
Description	High-speed floorstanding centrifuge with high capacity, ideal for harvesting of biomass in up to 6 L per run. Refrigerated for temperature sensitive samples.	2-in-1 high-speed floorstanding centrifuge with vacuum function, suitable for applications with super-speed requirements up to 110,000 x g and large volumes. Refrigerated for temperature sensitive samples.
Page(s)	76	80
Capacity¹⁾	up to 4 x 1.5 Liter	up to 4 x 1.5 Liter and continuous flow (>10 L)
Max. RCF	58,700 x g	110,000 x g
Max. speed	22,000 rpm	30,000 rpm
Temperature control range	-20 to 40°C	-20 to 40°C
Dimensions (WxDxH)	70 x 76 x 91.5 cm/ 27.5 x 30 x 36 in	70.8 x 89.2 x 86.6 cm/ 27.8 x 35.1 x 34 in
Height (with open lid)	151 cm/59.4 in	150 cm/59 in
Footprint (WxD)	70 x 76 cm/ 27.5 x 30 in	70.8 x 89.2 cm/ 27.8 x 35.1 in
Weight (w/o accessories)	260 kg/ 573.2 lbs	310 kg/ 683.4 lbs
Data export	Yes	Yes
Noise level (max.)	≤ 64 dB(A)	≤ 56 dB(A)
Display	5.7 inch color touch-sensitive LCD panel	6.5 inch color touch-sensitive LCD panel
Number of programs	33	1,000
Tracking of rotor usage	By serial number	By serial number
User management	yes	yes
Vacuum function	no	yes

¹⁾ Refers to the nominal volume. The maximum filling volume may depend on the application, rotor and speed. Please consult with your sales representative for further details.



**CP100NX/ CP90NX/ CP80NX**

Ultracentrifuge with a broad rotor portfolio. Three versions with shared functionality but different speed offerings are available to match your personal speed requirements.

84

up to 6 x 230 mL

803,000 x g/ 700,000 x g/ 615,000 x g

100,000 rpm/ 90,000 rpm/ 80,000 rpm

0 to 40°C

79 x 69 x 89 cm/ 31.1 x 27.1 x 35 in

88 cm/35 in

79 x 89 cm/ 31.1 x 35.0 in

390 kg/ 860 lbs

Yes

≤ 51 dB(A)

6.5 inch color touch-sensitive LCD panel

1,000

Rotor life management

yes

yes

**CS150FNX**

Floorstanding micro-ultracentrifuge with speeds of up to 1,050,000 x g in a very compact design.

86

up to 6 x 30 mL

1,050,000 x g

150,000 rpm

0 to 40°C

44 x 52 x 91 cm/ 17.3 x 20.5 x 35.8 in

91 cm/35.8 in

44 x 52 cm/ 17.3 x 20.5 in

105 kg/ 231 lbs

Yes

≤ 45 dB(A)

6.5 inch color touch-sensitive LCD panel

20

By serial number

yes

yes

**CS150NX**

Benchtop micro-ultracentrifuge with speeds of up to 1,050,000 x g, offering a flexible placement within the lab with standard electricity requirements and its compact design.

86

up to 6 x 30 mL

1,050,000 x g

150,000 rpm

0 to 40°C

59 x 58.2 x 40.8 cm/ 23.2 x 22.9 x 16 in

40.8 cm/16 in

59 x 58.2 cm/ 23.2 x 22.9 lbs

97 kg/ 214 lbs

Yes

≤ 45 dB(A)

6.5 inch color touch-sensitive LCD panel

20

By serial number

yes

yes



MiniSpin®/MiniSpin® plus



Description

MiniSpin® and MiniSpin® plus are entry-level mini centrifuges that are powerful, easy-to-use and small enough to allow individual workstations to be equipped with a portable centrifuge.

Product features

- > Rotor capacity: 12 × 1.5/2.0 mL vessels, 2 × 8-tube PCR strips
- > Max. speed: 14,100 × g (14,500 rpm)
- > Extremely compact footprint

Special features for MiniSpin plus

- > Automatic rpm/rcf conversion
- > Extended time to 99 min or continuous centrifugation



www.eppendorf.link/minispin



Rotor F-45-12-11

> for 12 × 1.5/2.0 mL tubes



Rotor F-55-16-5 PCR

> for 2 × PCR strips

Ordering information

Description	Order no.
Centrifuge MiniSpin®, keypad, non-refrigerated, with Rotor F-45-12-11, 230 V/50 – 60 Hz (GB)	5452000060
Centrifuge MiniSpin® plus, keypad, non-refrigerated, with Rotor F-45-12-11, 230 V/50 – 60 Hz (GB)	5453000060
Rotor F-45-12-11, angle 45°, 12 places, max. tube diameter 11 mm, incl. rotor lid and rotor nut, MiniSpin®/MiniSpin® plus	5452720008
Rotor F-55-16-5 PCR, angle 55°, 16 places, max. tube diameter 5 mm, incl. rotor lid (aluminum), MiniSpin®/MiniSpin® plus	5452727007
Adapter, for 1 PCR tube (0.2 mL, max. Ø 6 mm), for all 1.5/2.0 mL rotors, 6 pcs.	5425715005
Adapter, for 1 micro test tube (0.4 mL, max. Ø 6 mm), for all 1.5/2.0 mL rotors, 6 pcs.	5425717008
Adapter, for 1 sample tube (0.5 mL, max. Ø 8 mm) or 1 Microtainer® (0.6 mL, max. Ø 8 mm), for all 1.5/2.0 mL rotors, 6 pcs.	5425716001

✎ Ordering information for other voltage options can be found in the “Voltage Version” chapter.



Centrifuge 5418 R



Description

Centrifuge 5418 R is an 18-place microcentrifuge that is specifically designed for low to medium capacity in 1.5/2.0 mL tubes and Microtainer®. The speed of up to 16,873 × g allows for standard molecular biology applications.

Product features

- > Max. rotor capacity: 18 × 1.5/2.0 mL vessels
- > Max. speed: 16,873 × g (14,000 rpm)
- > Small footprint and low access height of 23 cm



Adapter for BD Microtainer® and 0.5 mL tubes

- > The adapter can be used with every Eppendorf rotor for 1.5/2.0 mL tubes



www.eppendorf.link/centrifuge5418R



Rotor FA-45-18-11

- > for 18 × 1.5/2.0 mL tubes, comes standard with unique Eppendorf QuickLock® aerosol-tight lid for fast and reliable locking



Adapter for 0.2 mL PCR Tubes

- > Ideal to spin down PCR Tubes after reaction setup. Adapter fits in any Eppendorf 1.5/2.0 mL rotor

Ordering information

Description	Order no.
Centrifuge 5418 R , rotary knobs, refrigerated, with Rotor FA-45-18-11 and rotor lid, 230 V/50 – 60 Hz (GB)	5401000060
Rotor FA-45-18-11 , aerosol-tight, 45° angle, 18 places, max. tube Ø 11 mm, incl. rotor lid (aluminum)	5418707005
Adapter , for 1 PCR tube (0.2 mL, max. Ø 6 mm), for all 1.5/2.0 mL rotors, 6 pcs.	5425715005
Adapter , for 1 sample tube (0.5 mL, max. Ø 8 mm) or 1 Microtainer® (0.6 mL, max. Ø 8 mm), for all 1.5/2.0 mL rotors, 6 pcs.	5425716001
Adapter , for 1 micro test tube (0.4 mL, max. Ø 6 mm), for all 1.5/2.0 mL rotors, 6 pcs.	5425717008

✎ Ordering information for other voltage options can be found in the “Voltage Version” chapter.





Centrifuge 5420



Description

Centrifuge 5420 supports your nucleic acid purification and gel-extraction workflows. This centrifuge offers 24-place capacity in an aerosol-tight rotor and speeds up to $21,300 \times g$ in a small footprint.

Product features

- > Standard rotor for up to 24 x 1.5 and 2.0 mL tubes
- > Rotor option for up to 32 x 0.2 mL PCR tubes or 4 x 8-place PCR strips
- > Adapters for 0.2, 0.4 and 0.5 mL tubes as well as 0.6 mL BD Microtainer®



www.eppendorf.link/centrifuge5420



Rotor FA-24x2

- > Max. speed: $21,300 \times g$ (15,060 rpm)
- > Max. capacity: 24 x 1.5/2.0 mL tubes
- > Aerosol-tight



Rotor F-32x0.2-PCR

- > Max. speed: $18,257 \times g$ (15,060 rpm)
- > Max capacity: 4 x PCR strips or 32 x PCR tubes (0.2 mL)

Ordering information

Description	Order no.
Centrifuge 5420, keypad, non-refrigerated, without rotor, 230 V/50 – 60 Hz (GB)	5420000369
Centrifuge 5420, keypad, non-refrigerated, with aerosol-tight Rotor FA-24x2, 230 V/50 – 60 Hz (GB)	5420000164
Rotor F-32x0.2-PCR, incl. rotor lid, for 32 x 0.2 mL PCR tubes or 4 x 8 PCR tube strips, for 5420	5495404007
Rotor FA-24x2, aerosol-tight, incl. rotor lid, aerosol-tight, for 24 x 1.5/2.0 mL tubes, for 5420	5495400001
Adapter, for 1 PCR tube (0.2 mL, max. Ø 6 mm), for all 1.5/2.0 mL rotors, 6 pcs.	5425715005
Adapter, for 1 sample tube (0.5 mL, max. Ø 8 mm) or 1 Microtainer® (0.6 mL, max. Ø 8 mm), for all 1.5/2.0 mL rotors, 6 pcs.	5425716001
Adapter, for 1 micro test tube (0.4 mL, max. Ø 6 mm), for all 1.5/2.0 mL rotors, 6 pcs.	5425717008

✎ Ordering information for other voltage options can be found in the “Voltage Version” chapter.



Centrifuge 5425/5425 R



www.eppendorf.link/centrifuge5425-5425R

Description

Eppendorf microcentrifuges 5425 and 5425 R are true laboratory standards. These whisper quiet 24-place microcentrifuges offer an outstanding set of features for a broad range of molecular and cell biology applications in Eppendorf and PCR tubes from 0.2 to 5 mL. The refrigerated Centrifuge 5425 R provides precise temperature control for processing temperature-sensitive samples with its advanced cooling system.

Product features

- > Aerosol-tight Eppendorf QuickLock® lids for simple and safe handling
- > Outstanding software features (e.g. adjustable acceleration and braking ramps, 3 program buttons (only Centrifuge 5425), short function without continuous pressing of the key)
- > Extended rotor program (e.g. 5.0 mL rotor, swing-bucket rotor for PCR strips)

Main Features



Enhanced convenience

- > One push short-spin key – no need to hold key all the while



Improved ergonomics

- > Eppendorf QuickLock® rotors for ergonomic lid locking
- > Closes with only a 1/4 turn and takes repetitive stress of your wrist



Increased versatility

- > Swing-bucket rotor for divisible plates to speed up your PCR/qPCR setup
- > 10-place 5.0 mL rotor for screw cap and snap lid tubes

Ordering information

Description	Order no.
Centrifuge 5425, keypad, non-refrigerated, without rotor, 230 V/50 – 60 Hz (GB)	5405000360
Centrifuge 5425, rotary knobs, non-refrigerated, without rotor, 230 V/50 – 60 Hz (GB)	5405000760
Centrifuge 5425, keypad, non-refrigerated, with Rotor FA-24x2, 230 V/50 – 60 Hz (GB)	5405000166
Centrifuge 5425, rotary knobs, non-refrigerated, with Rotor FA-24x2, 230 V/50 – 60 Hz (GB)	5405000565
Centrifuge 5425, rotary knobs, non-refrigerated, Molecular Biology Solution, with Rotor FA-18x2-Kit, 230 V/50 – 60 Hz (GB)	5405000182
Centrifuge 5425 R, keypad, refrigerated, without rotor, 230 V/50 – 60 Hz (GB)	5406000364
Centrifuge 5425 R, rotary knobs, refrigerated, without rotor, 230 V/50 – 60 Hz (GB)	5406000763
Centrifuge 5425 R, keypad, refrigerated, with Rotor FA-24x2, 230 V/50 – 60 Hz (GB)	5406000160
Centrifuge 5425 R, rotary knobs, refrigerated, with Rotor FA-24x2, 230 V/50 – 60 Hz (GB)	5406000569

✎ Ordering information for other voltage options can be found in the “Voltage Version” chapter.



Your local distributor: www.eppendorf.link/contact

Eppendorf UK Limited · Gateway 1000 · Whittle Way · Stevenage SG1 2FP · United Kingdom · sales@eppendorf.co.uk · www.eppendorf.com · www.eppendorf.link/eshop



Rotors for Centrifuge 5425/5425R



Rotors FA-24x2

- > Max. speed: 21,300 × g (15,060 rpm)
- > Max. capacity: 24 × 1.5/2.0 mL tubes
- > Aerosol-tight with Eppendorf QuickLock® lid



Rotor FA-24x2-PTFE

- > Max. speed: 21,300 × g (15,060 rpm)
- > Max. capacity: 24 × 1.5/2.0 mL tubes
- > Aerosol-tight with Eppendorf QuickLock® lid
- > PTFE coating for increased chemical resistance



Rotor FA-10x5

- > Max. speed: 21,300 × g (15,060 rpm)
- > Max capacity: 10 × Eppendorf Tubes® 5.0 mL
- > Aerosol-tight with Eppendorf QuickLock® lid



Rotor FA-18x2 Kit

- > Max. speed: 18,565 × g (15,060 rpm)
- > Rotor with higher edge for safe centrifugation of up to 18 spin columns
- > Aerosol-tight with Eppendorf QuickLock® lid



Rotor F-32x0.2-PCR

- > Max. speed: 18,134 × g (15,060 rpm)
- > for 4 × PCR strips or 32 × PCR tubes (0.2 mL)



Rotor 96x0.2-PCR

- > Max. speed: 3,217 × g (6,000 rpm)
- > Unique swing bucket rotor for 12 × 8 PCR strips 0.1/0.2 mL or 4 × 1/4 twin.tec® PCR plate 96, unskirted divisible or 96 × PCR tubes 0.2 mL

Ordering information

Description	Order no.
Rotor FA-24x2, aerosol-tight, incl. rotor lid, for 24 × 1.5/2.0 mL tubes	5495500006
Rotor FA-24x2-PTFE, aerosol-tight, incl. rotor lid, PTFE coated, for 24 × 1.5/2.0 mL tubes	5495503005
Rotor FA-10x5, aerosol-tight, incl. rotor lid, for 10 × 5.0 mL tubes (snap and screw cap)	5495505008
Rotor FA-18x2-Kit, aerosol-tight, incl. rotor lid, for 18 × 1.5/2.0 mL tubes or spin columns	5495508007
Rotor F-32x0.2-PCR, incl. rotor lid, for 32 × 0.2 mL PCR tubes or 4 × 8 PCR strips	5495510001
Rotor S-96x0.2-PCR, for 96 × 0.2 mL PCR tubes or 12 × 8 PCR strips, incl. buckets	5495512004
Adapter, for 1 PCR tube (0.2 mL, max. Ø 6 mm), for all 1.5/2.0 mL rotors, 6 pcs.	5425715005
Adapter, for 1 sample tube (0.5 mL, max. Ø 8 mm) or 1 Microtainer® (0.6 mL, max. Ø 8 mm), for all 1.5/2.0 mL rotors, 6 pcs.	5425716001
Adapter, for 1 vessel 1.5 – 2.0 mL, for all 5.0 mL rotors, 4 pcs.	5820768002
Adapter, for 1 cryo tube, for all 5.0 mL rotors, 4 pcs.	5820769009
Adapter, for 1 HPLC tube, for all 5.0 mL rotors, 4 pcs.	5820770007
Adapter, for 1 micro test tube (0.4 mL, max. Ø 6 mm), for all 1.5/2.0 mL rotors, 6 pcs.	5425717008



Centrifuge 5427 R

New



Description

Eppendorf Centrifuge 5427 R is a high-speed, refrigerated microcentrifuge for high-throughput research. It doubles your tube capacity compared to a standard 24-place microcentrifuge thanks to its 48-place double-row rotor, while contributing to a more sustainable lab environment with its natural refrigerant.

Product features

- > Cooled with natural refrigerant (R290) to protect your samples - and the planet
- > Rotor capacity: 48 × 1.5/2.0 mL, 12 × 5.0 mL; Eppendorf QuickLock® rotor allows for fast and ergonomic lid locking
- > Max. speed: 25,001 × g (16,220 rpm)



www.eppendorf.link/centrifuge5427R

Ordering information

Description

Centrifuge 5427 R, rotary knobs, refrigerated, without rotor, 230 V/50 – 60 Hz (GB)

Centrifuge 5427 R, rotary knobs, refrigerated, with Rotor FA-45-30-11 (30x tubes), 230 V/50 – 60 Hz (GB)

Centrifuge 5427 R, rotary knobs, refrigerated, with Rotor FA-45-48-11 (48x tubes), 230 V/50 – 60 Hz (GB)

Order no.

[5429000060](#)

[5429000360](#)

[5429000260](#)

✎ Ordering information for other voltage options can be found in the “Voltage Version” chapter.



Rotor S-24-11-AT

- > Max. speed: 16,049 × g (12,700 rpm)
- > Swing-bucket rotor for 24 × 1.5/2.0 mL tubes
- > Aerosol-tight with Eppendorf QuickLock® lid



Rotor FA-45-12-17

- > Max. speed: 20,598 × g (14,000 rpm)
- > Max capacity: 12 × Eppendorf Tubes® 5.0 mL
- > Aerosol-tight with Eppendorf QuickLock® lid



Rotor F-45-48-5-PCR

- > Max. speed: 11,710 × g (10,500 rpm)
- > PCR strip rotor for up to 48 × 0.2 mL PCR tubes

Rotor options continued on next page.





Rotors for Centrifuge 5427 R



Rotor F-45-48-11

- > Max. speed: 18,213 × g (12,700 rpm)
- > Max. capacity: 48 × 1.5/2.0 mL tubes



Rotor FA-45-48-11

- > Max. speed: 18,213 × g (12,700 rpm)
- > Max. capacity: 48 × 1.5/2.0 mL tubes
- > Aerosol-tight with Eppendorf QuickLock® lid



Rotor FA-45-30-11

- > Max. speed: 20,817 × g (14,000 rpm)
- > Max. capacity: 30 × 1.5/2.0 mL tubes
- > Aerosol-tight with Eppendorf QuickLock® lid



Rotor F-45-30-11

- > Max. speed: 20,817 × g (14,000 rpm)
- > Max. capacity: 30 × 1.5/2.0 mL tubes



Rotor FA-45-24-11

- > Max. speed: 25,001 × g (16,220 rpm)
- > Max. capacity: 24 × 1.5/2.0 mL tubes
- > Aerosol-tight with Eppendorf QuickLock® lid



Rotor FA-45-24-11-Kit

- > Max. speed: 19,090 × g (13,200 rpm)
- > Rotor with higher rim for safe centrifugation of up to 24 spin columns
- > Aerosol-tight with Eppendorf QuickLock® lid

Ordering information

Description	Order no.
Rotor FA-45-48-11, aerosol-tight, incl. rotor lid, for 5427R	5409710001
Rotor F-45-48-11, incl. rotor lid, aluminum	5409712004
Rotor FA-45-30-11, aerosol-tight, incl. rotor lid, aluminum	5409706004
Rotor F-45-30-11, incl. rotor lid, aluminum	5409708007
Rotor FA-45-24-11, aerosol-tight, incl. rotor lid, aluminum	5409702009
Rotor FA-45-24-11-Kit, aerosol-tight, incl. rotor lid, aluminum	5409704001
Rotor S-24-11-AT, aerosol-tight, stainless steel	5409715003
Rotor F-45-48-5-PCR, aluminum	5409714007
Rotor FA-45-12-17, aerosol-tight, incl. rotor lid, aluminum	5409700006
Adapter, for 1 PCR tube (0.2 mL, max. Ø 6 mm), for all 1.5/2.0 mL rotors, 6 pcs.	5425715005
Adapter, for 1 sample tube (0.5 mL, max. Ø 8 mm) or 1 Microtainer® (0.6 mL, max. Ø 8 mm), for all 1.5/2.0 mL rotors, 6 pcs.	5425716001
Adapter, for 1 vessel 1.5 – 2.0 mL, for all 5.0 mL rotors, 4 pcs.	5820768002
Adapter, for 1 cryo tube, for all 5.0 mL rotors, 4 pcs.	5820769009
Adapter, for 1 HPLC tube, for all 5.0 mL rotors, 4 pcs.	5820770007
Adapter, for 1 micro test tube (0.4 mL, max. Ø 6 mm), for all 1.5/2.0 mL rotors, 6 pcs.	5425717008



Centrifuge 5430/5430 R



Description

Combine the best of both worlds with Centrifuge 5430 and 5430 R. These high-speed centrifuges have the small footprint of a microcentrifuge and the versatility of a multipurpose centrifuge.

Product features

- > Max. rotor capacity: 48 × 1.5/2.0 mL, 6 × 50 mL, 2 × MTP
- > Max. speed: 30,130 × g (17,500 rpm)
- > Remarkable versatility with 12 different rotors



www.eppendorf.link/centrifuge5430

Ordering information

Description	Order no.
Centrifuge 5430, keypad, non-refrigerated, without rotor, 230 V/50 – 60 Hz (GB)	5427000060
Centrifuge 5430, rotary knobs, non-refrigerated, without rotor, 230 V/50 – 60 Hz (GB)	5427000660
Centrifuge 5430, keypad, non-refrigerated, with Rotor FA-45-30-11 incl. rotor lid, 230 V/50 – 60 Hz (GB)	5427000260
Centrifuge 5430, rotary knobs, non-refrigerated, with Rotor FA-45-30-11 incl. rotor lid, 230 V/50 – 60 Hz (GB)	5427000465
Centrifuge 5430, rotary knobs, non-refrigerated, Low-Throughput Plate Solution, with Rotor A-2-MTP, 230 V/50 – 60 Hz (GB)	5427000186
Centrifuge 5430 R, keypad, refrigerated, without rotor, 230 V/50 – 60 Hz (GB)	5428000255
Centrifuge 5430 R, rotary knobs, refrigerated, without rotor, 230 V/50 – 60 Hz (GB)	5428000655
Centrifuge 5430 R, keypad, refrigerated, with Rotor FA-45-30-11 incl. rotor lid, 230 V/50 – 60 Hz (GB)	5428000060
Centrifuge 5430 R, rotary knobs, refrigerated, with Rotor FA-45-30-11 incl. rotor lid, 230 V/50 – 60 Hz (GB)	5428000460

✎ Ordering information for other voltage options can be found in the “Voltage Version” chapter.

Rotors for Centrifuge 5430/5430 R



Rotor FA-45-48-11

- > Max. speed: 18,210 × g (12,700 rpm)
- > Max. capacity: 48 × 1.5/2.0 mL tubes
- > Aerosol-tight for safe centrifugation of hazardous samples



Rotor F-45-48-11

- > Max. speed: 18,210 × g (12,700 rpm)
- > Max. capacity: 48 × 1.5/2.0 mL tubes



Rotor S-24-11-AT

- > Max. speed: 16,049 × g (12,700 rpm)
- > Swing-bucket rotor for 24 × 1.5/2.0 mL tubes
- > Aerosol-tight with Eppendorf QuickLock® lid





Rotors for Centrifuge 5430/5430 R



Rotor FA-45-16-17

- > Max. speed: 21,191 × g (14,200 rpm)
- > Max. capacity: 16 × Eppendorf Tubes® 5.0 mL¹⁾
- > Aerosol-tight for safe centrifugation of hazardous samples

¹⁾ Snap cap - reduced capacity for 5 mL screw cap tubes



Rotor FA-45-30-11

- > Max. speed: 25,000 × g (15,350 rpm)
- > Max. capacity: 30 × 1.5/2.0 mL tubes
- > Aerosol-tight for safe centrifugation of hazardous samples



Rotor FA-45-24-11-Kit

- > Max. speed: 19,090 × g (13,200 rpm)
- > Rotor with higher rim for safe centrifugation of up to 24 spin columns
- > Aerosol-tight for safe centrifugation of hazardous samples



Rotor F-45-30-11

- > Max. speed: 20,817 × g (14,000 rpm)
- > Max. capacity: 30 × 1.5/2.0 mL tubes
- > PTFE coating for increased chemical resistance



Rotor FA-45-24-11-HS

- > Max. speed: 30,130 × g (17,500 rpm)
- > Max. capacity: 24 × 1.5/2.0 mL tubes
- > Extremely fast separation results
- > Aerosol-tight for safe centrifugation of hazardous samples
- > PTFE coating for increased chemical resistance



Rotor F-35-6-30

- > Max. speed: 7,745 × g (7,830 rpm)
- > Rotor for 6 × 15/50 mL conical or 12 × Vacutainer® tubes



Rotor A-2-MTP

- > Max. speed: 2,204 × g (4,680 rpm)
- > 2-place swing-bucket rotor for MTP, PCR and Deepwell Plates (max. 0.5 mL)
- > Windshield design for quiet operation



Rotor F-45-64-5-PCR

- > Max. speed: 13,543 × g (11,800 rpm)
- > PCR strip rotor for up to 64 × 0.2 mL PCR tubes



Rotor F-45-18-17-Cryo

- > Max. speed: 8,324 × g (8,900 rpm)
- > 18-place rotor for Cryo tubes



Ordering information

Description	Order no.
Rotor FA-45-16-17 , aerosol-tight, incl. rotor lid, for 16 × Eppendorf Tubes® 5.0 mL	5427750002
Adapter , for 1 PCR tube (0.2 mL, max. Ø 6 mm), for all 1.5/2.0 mL rotors, 6 pcs.	5425715005
Adapter , for 1 sample tube (0.5 mL, max. Ø 8 mm) or 1 Microtainer® (0.6 mL, max. Ø 8 mm), for all 1.5/2.0 mL rotors, 6 pcs.	5425716001
Rotor FA-45-48-11 , aerosol-tight, incl. rotor lid, for 5430/5430R	5427754008
Rotor F-45-48-11 , incl. rotor lid	5427755004
Rotor S-24-11-AT , aerosol-tight, incl. rotor lid, stainless steel	5427757007
Rotor FA-45-30-11 , aerosol-tight, incl. rotor lid, for 5430/5430R	5427753001
Rotor FA-45-24-11-Kit , aerosol-tight, incl. rotor lid	5427752005
Rotor F-45-30-11 , incl. rotor lid, PTFE coated	5427712003
Rotor FA-45-24-11-HS , aerosol-tight, incl. rotor lid, PTFE coated	5427710000
Rotor F-35-6-30 , incl. rotor lid, with 6 adapters each for 15 mL/50 mL conical tubes	5427716009
Rotor A-2-MTP , incl. wind shield and rotor lid, with 2 buckets	5427700005
Rotor F-45-64-5-PCR , incl. rotor lid and adapters	5427714006
Rotor F-45-18-17-Cryo , incl. rotor lid and cryovial adapters	5427705007
Adapter , for 1 cryo tubes (max. Ø 13 mm) or sealable centrifugation tubes (Ø 12.2 mm), max. length 50 mm, for Rotor F-45-18-17-Cryo, 6 pcs.	5702752002
Adapter , for 1 vessel 1.5 – 2.0 mL, for all 5.0 mL rotors, 4 pcs.	5820768002
Adapter , for 1 cryo tube, for all 5.0 mL rotors, 4 pcs.	5820769009
Adapter , for 1 HPLC tube, for all 5.0 mL rotors, 4 pcs.	5820770007
Adapter , for 1 micro test tube (0.4 mL, max. Ø 6 mm), for all 1.5/2.0 mL rotors, 6 pcs.	5425717008
Adapter , for 1 HPLC vessel 1.5 mL, for Rotor F-45-18-17-Cryo, 18 pcs.	5427708006

Adapter options for Rotor F-35-6-30

Adapter	Rotor capacity ³⁾	Max. tube dimensions Ø x L	Max. RCF	For bore hole	Order no. ⁴⁾
13 mm round	12	13 × 65 – 89 mm	6,443 × g	small	5427740007
			6,100 × g	large	5427742000
13 mm round	12	13 × 90 – 110 mm	7,471 × g	small	5427741003
			7,129 × g	large	5427743006
16 mm round	12	16 × 75 – 105 mm	7,005 × g	small	5427732004
			7,005 × g	large	5427734007
17 mm round	12	17 × 90 – 125 mm	7,745 × g	small	5427735003
			7,403 × g	large	5427738002
Eppendorf Tubes® 5.0 mL	12	17.5 × 80 mm	6,237 × g	small	5427746005
			7,129 × g	large	5427747001
15 mL conical	6	17.5 × 100 – 125 mm	7,540 × g	small	5427726004
30 mL round	6	26 × 92 – 112 mm	7,087 × g	large	5427736000
50 mL round	6	29 × 95 – 125 mm	7,581 × g	large	5427737006
50 mL conical	6 ^{1) 2)}	29.5 × 100 – 125 mm	7,197 × g	large	5427727000
Centriprep®	6	29.5 × 100 – 125 mm	7,567 × g	large	5427723005

¹⁾ Three sets of 2 included with Rotor F-35-6-30. ²⁾ Adapter accommodates skirted 50 mL conical tubes. ³⁾ Please perform a manual test to determine the actual loading capacity. ⁴⁾ Set of 2





Centrifuge 5702/5702 R/5702 RH









www.eppendorf.link/centrifuge5702

Ordering information

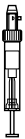
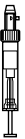
Description	Order no.
Centrifuge 5702 , rotary knobs, non-refrigerated, without rotor, 230 V/50 – 60 Hz (GB)	5702000065
Centrifuge 5702 , rotary knobs, non-refrigerated, with Rotor A-4-38 incl. adapters for 15/50 mL conical tubes, 2 sets of 2 adapters, 230 V/50 – 60 Hz (GB)	5702000365
Centrifuge 5702 R , rotary knobs, refrigerated, without rotor, 230 V/50 – 60 Hz (GB)	5703000060
Centrifuge 5702 R , rotary knobs, refrigerated, with Rotor A-4-38 incl. adapters for 13/16 mm blood collection tubes, 2 sets of 2 adapters, 230 V/50 – 60 Hz (GB)	5703000360
Centrifuge 5702 R , rotary knobs, refrigerated, with Rotor A-4-38 incl. adapters for 15/50 mL conical tubes, 2 sets of 2 adapters, 230 V/50 – 60 Hz (GB)	5703000460
Centrifuge 5702 RH , rotary knobs, refrigerated/heated, without rotor, 230 V/50 – 60 Hz (GB)	5704000060
Centrifuge 5702 , rotary knobs, non-refrigerated, with Rotor A-4-38 incl. adapters for round-bottom tubes 4 – 10 mL and adapters for round-bottom tubes 2.6 – 7 mL, 2 sets of 2 adapters, 230 V/50 – 60 Hz (EU)	5702000515

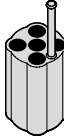
✎ Ordering information for other voltage options can be found in the “Voltage Version” chapter.

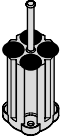
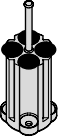
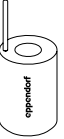
						
Adapters for Rotor A-4-38 with round buckets						
Tube Volume	1.5 – 2.0 mL	1 – 1.4 mL	2 – 7 mL	2.6 – 7 mL	4 – 10 mL	Eppendorf Tubes® 5.0 mL
Max. tube diameter	11 mm	8.5 mm	12.5 mm	13.5 mm	16 mm	17 mm
Max. vessel height	43 mm	100 mm	100 mm	100 mm	100 mm	60 mm
Max. vessel height for use with cap/lid¹⁾	43 mm	100 mm	100 mm	100 mm	100 mm	60 mm
Adapter						
Number of vessels per adapter/rotor	4/16	5/20	5/20	4/16	4/16	1/4
Bottom shape	round	flat	flat	flat	flat	flat
Centrifugation radius	134 mm	132 mm	132 mm	132 mm	132 mm	136 mm
Max. RCF	2,900 × g	2,850 × g	2,850 × g	2,850 × g	2,850 × g	2,943 × g
Packing	2 pcs.	2 pcs.	2 pcs.	2 pcs.	2 pcs.	2 pcs.
Order no.	5702745006	5702736007	5702737003	5702719005	5702735000	5702733008

¹⁾ Exceeding the maximum tube length may reduce the loading capacity of the rotor. Please perform a manual swing-out test before starting the centrifuge run to make sure the tubes do not hit the rotor yoke.

²⁾ Please order adapter for 25 mL conical tubes screw cap 5820734000. ³⁾ Please order adapter for 25 mL conical tubes snap cap 5820733004.



Description

Are you looking to improve your work environment? The 5702 family of low-speed centrifuges are quiet in operation, compact in design and provide six different rotor options to accommodate any type of tube and requirement for low to mid-throughput applications in immunology research and cell culture.



Rotor A-4-38 with round buckets

- > Maximum speed: 3,000 × g (4,400 rpm)
- > Standard rotor for centrifugation of blood collection tubes or 15/50 mL conical tubes
- > Round buckets for vessels with 1.5 – 100 mL

Ordering information

Description	Order no.
Rotor A-4-38 with round buckets , 8 positions, max. Ø 38 mm, incl. 4 round buckets 100 mL	5702720003
16 x 125 mm bucket , for 16 x 125 mm round bottom tubes, non aerosol-tight, for rotor A-4-38, 4 pcs.	5702764000
Rotor A-4-38 , 8 positions, max. Ø 38 mm, without buckets	5702740004
Round bucket 100 mL , for Rotor A-4-38, 4 pcs.	5702722006
Caps for 100 mL round buckets , aerosol-tight, 2 pcs.	5702721000

9 – 15 mL	15 mL conical	15 mL conical	25 mL	25 mL screw cap ²⁾	25 mL snap cap ³⁾	50 mL screw cap	85/100 mL
17.5 mm	17.2 mm	17.2 mm	39 mm	30 mm	30 mm	30 mm	38 mm
100 mm	121 mm	121 mm		78.5 mm	83 mm	115 mm	106 mm
100 mm	120 mm	–		78.5 mm	83 mm	115 mm	106 mm
4/16	1/4	2/8	1/4	1/4	1/4	1/4	1/4
round	conical	conical	conical		conical		round
130 mm	137 mm	137 mm		97 mm	107 mm	135 mm	135 mm
2,800 × g	3,000 × g	3,000 × g		2,100 × g	2,316 × g	2,900 × g	2,900 × g
2 pcs.	2 pcs.	2 pcs.	2 pcs.		2 pcs.		2 pcs.
5702724009	5702732001	5702723002	5702717002		5702734004		5702718009

















Rotors for Centrifuge 5702/5702 R/5702 RH

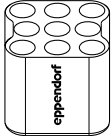

Rotor A-4-38 with rectangular buckets

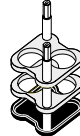
- > Maximum speed: 2,750 × g (4,400 rpm)
- > Rectangular buckets for vessels with 5 – 25 mL
- > Autoclavable rotor-cross and buckets

						
Adapters for Rotor A-4-38 with rectangular buckets						
Tube Volume	round-bottom tubes	5 – 7 mL	9 mL	15 mL	25 mL	20 mL
Max. tube diameter	12 mm	13 mm	14.5 mm	17.5 mm	25 mm	22 mm
Max. vessel height	75 mm	100 mm	100 mm	100 mm	100 mm	100 mm
Adapter						
Number of vessels per adapter/rotor	9/36	10/40	8/32	6/24	2/8	4/16
Bottom shape	round	flat	flat	flat	flat	flat
Centrifugation radius	119 mm	127 mm	127 mm	127 mm	127 mm	127 mm
Max. RCF	2,577 × g	2,750 × g	2,750 × g	2,750 × g	2,750 × g	2,750 × g
Packing	2 pcs.	2 pcs.	2 pcs.	2 pcs.	2 pcs.	2 pcs.
Order no.	5702763004	5702710008	5702711004	5702712000	5702716006	5702713007

Ordering information

Description	Order no.
Rotor A-4-38, 8 positions, max. Ø 38 mm, without buckets	5702740004
Rectangular bucket 90 mL, for Rotor A-4-38, 4 pcs.	5702709000

**Rotor A-8-17**

- > Maximum speed: $2,800 \times g$ (4,400 rpm)
- > Low capacity rotor for centrifugation of 15 mL conical tubes or 15 mL glass tubes¹⁾
- > Adapters for 15 mL conical tubes and rubber mat inserts for glass tubes optionally available

¹⁾ Max. vessel height: 120 mm

**Rotor F-35-30-17**

- > Maximum speed: $2,750 \times g$ (4,400 rpm)
- > High capacity rotor for 20 × 15 mL conical tubes or 30 × 15 mL glass tubes
- > Inserts for 15 mL conical tubes and rubber mats for use with glass tubes are included

**Rotor F-45-24-11**

- > Maximum speed: $1,770 \times g$ (4,400 rpm)
- > Fixed-angle rotor for 24 × 1.5/2.0 mL tubes
- > Quiet centrifugation even without rotor lid
- > Adapters optionally available for:
 - 0.2 mL PCR tubes (5425715005)
 - 0.4 mL centrifuge tubes (5425717008)
 - 0.5 mL micro test tubes and BD Microtainer® tubes (5425716001)
- > Rotor and adapters are autoclavable (121 °C, 20 min)

**Rotor F-45-18-17-Cryo**

- > Maximum speed: $1,970 \times g$ (4,400 rpm)
- > Quiet centrifugation even without rotor lid
- > Centrifugation of 1 – 2 mL cryo container (max. 13 mm Ø, use with adapter) and tubes with screw cap (max. 17 mm Ø, no adapter required)
- > Rotor and adapters are autoclavable (121 °C, 20 min)

Ordering information

Description	Order no.
Rotor A-8-17 , 8 × 15 mL, without adapter, without rubber mats	5702700002
Rotor F-35-30-17 , incl. 30 steel sleeves for 15 mL vessels, with 20 adapters for conical tubes and 30 rubber mats	5702704008
Rotor F-35-30-17 , incl. 10 steel sleeves for 15 mL vessels, with 10 adapters for conical tubes and 10 rubber mats	5702705004
Rotor F-45-24-11 , 45° angle, 24 places, max. Ø 11 mm, without lid	5702746002
Rotor F-45-18-17-Cryo , without rotor lid, without adapters	5702747009
Adapter , for 1 PCR tube (0.2 mL, max. Ø 6 mm), for all 1.5/2.0 mL rotors, 6 pcs.	5425715005
Adapter , for 1 sample tube (0.5 mL, max. Ø 8 mm) or 1 Microtainer® (0.6 mL, max. Ø 8 mm), for all 1.5/2.0 mL rotors, 6 pcs.	5425716001
Adapter , for 1 cryo tubes (max. Ø 13 mm) or sealable centrifugation tubes (Ø 12.2 mm), max. length 50 mm, for Rotor F-45-18-17-Cryo, 6 pcs.	5702752002
Adapter , for 1 micro test tube (0.4 mL, max. Ø 6 mm), for all 1.5/2.0 mL rotors, 6 pcs.	5425717008
Adapter , for 1 HPLC vessel 1.5 mL, for Rotor F-45-18-17-Cryo, 18 pcs.	5427708006





Centrifuge 5804/5804 R and 5810/5810 R



Centrifuge Packages 58xx Family



[www.eppendorf.com/
centrifuge5810](http://www.eppendorf.com/centrifuge5810)



Description

Whether you need a refrigerated or non-refrigerated centrifuge for low or medium throughput applications, one of these packages will definitely suit your requirements.

Cell Culture Centrifuge packages include

- > Centrifuge 5702/5702 R, 5804/5804 R or 5810/5810 R
- > Swing-bucket rotor incl. buckets
- > Four adapters for 15 mL conical tubes (two sets of 2)
- > Four adapters for 50 mL conical tubes (two sets of 2)

Centrifuge packages for round-bottom tubes include

- > Centrifuge 5810/ 5810 R
- > Swing-bucket rotor S-4-104 incl. buckets
- > Four adapters for 13 mm (5/7 mL) round bottom tubes (two sets of 2)
- > Four adapters for 16 mm (10 mL) round bottom tubes (two sets of 2)

Eppendorf Conical Tubes 15 mL, 25 mL and 50 mL

The Eppendorf Conical Tubes are the optimal solution for sample preparation protocols in microbiology and molecular biology laboratories. Safe design and easy handling ensure best sample processing.

Premium raw material ensures

- > Highest sample integrity
- > High g-Safe® centrifugation stability
- > Optimal sample and pellet visibility

[For more information go to chapter "tubes and plates".](#)



Ordering information

Description	Order no.
Centrifuge 5804 , keypad, non-refrigerated, without rotor, 230 V/50 – 60 Hz (GB)	5804000060
Centrifuge 5804 R , keypad, refrigerated, without rotor, 230 V/50 – 60 Hz (GB)	5805000060
Centrifuge 5810 , keypad, non-refrigerated, without rotor, 230 V/50 – 60 Hz (GB)	5810000060
Centrifuge 5810 R , keypad, refrigerated, without rotor, 230 V/50 – 60 Hz (GB)	5811000065

✎ Ordering information for other voltage options can be found in the “Voltage Version” chapter.

Number of vessels per adapter/rotor

Centrifuge Packages 58xx Family	15 mL conical	50 mL conical
5702/5702 R	2/8	1/4
5804/5804 R + Rotor A-4-44	4/16	1/4
5804/5804 R + Rotor S-4-72	8/32	4/16
5810/5810 R + Rotor A-4-62	9/36	4/16
5810/5810 R + Rotor A-4-81	12/48	5/20
5810/5810 R + Rotor S-4-104	14/56	7/28
	13 mm	16 mm
5810/5810 R + S-4-104	23/92	20/80

Ordering information

Description	Conical tubes	Order no.
Centrifuge 5804 , keypad, non-refrigerated, with Rotor A-4-44 incl. adapters for 15/50 mL conical tubes, 230 V/50 – 60 Hz (GB)	16 × 15 mL/4 × 50 mL	5804000360
Centrifuge 5804 R , keypad, refrigerated, with Rotor A-4-44 incl. adapters for 15/50 mL conical tubes, 230 V/50 – 60 Hz (GB)	16 × 15 mL/4 × 50 mL	5805000365
Centrifuge 5804 , keypad, non-refrigerated, with Rotor S-4-72 incl. adapters for 15/50 mL conical tubes, 230 V/50 – 60 Hz (GB)	32 × 15 mL/16 × 50 mL	5804000565
Centrifuge 5804 R , keypad, refrigerated, with Rotor S-4-72 incl. adapters for 15/50 mL conical tubes, 230 V/50 – 60 Hz (GB)	32 × 15 mL/16 × 50 mL	5805000665
Centrifuge 5810 , keypad, non-refrigerated, with Rotor A-4-62 incl. adapters for 15/50 mL conical tubes, 230 V/50 – 60 Hz (GB)	36 × 15 mL/16 × 50 mL	5810000365
Centrifuge 5810 R , keypad, refrigerated, with Rotor A-4-62 incl. adapters for 15/50 mL conical tubes, 230 V/50 – 60 Hz (GB)	36 × 15 mL/16 × 50 mL	5811000360
Centrifuge 5810 , keypad, non-refrigerated, with Rotor A-4-81 incl. adapters for 15/50 mL conical tubes, 230 V/50 – 60 Hz (GB)	48 × 15 mL/20 × 50 mL	5810000460
Centrifuge 5810 R , keypad, refrigerated, with Rotor A-4-81 incl. adapters for 15/50 mL conical tubes, 230 V/50 – 60 Hz (GB)	48 × 15 mL/20 × 50 mL	5811000465
Centrifuge 5810 , keypad, non-refrigerated, Classic Cell Culture Solution, with Rotor S-4-104 including 4 adapters for 5/15 mL tubes and 4 adapters for 50 mL conical tubes, 230 V/50 – 60 Hz (GB)	56 × 15 mL/28 × 50 mL	5810000560
Centrifuge 5810 R , keypad, refrigerated, with Rotor S-4-104 incl. adapters for 15/50 mL conical tubes, 230 V/50 – 60 Hz (GB)	56 × 15 mL/28 × 50 mL	5811000660
Centrifuge 5810 , keypad, non-refrigerated, with Rotor S-4-104 incl. adapters for 13/16 mm round-bottom tubes, 230 V/50 – 60 Hz (GB)	56 × 15 mL/28 × 50 mL 92 × 13 mm/80 × 16 mm	5810000665
Centrifuge 5810 R , keypad, refrigerated, with Rotor S-4-104 incl. adapters for 13/16 mm round-bottom tubes, 230 V/50 – 60 Hz (GB)	56 × 15 mL/28 × 50 mL 92 × 13 mm/80 × 16 mm	5811000865

✎ Ordering information for other voltage options can be found in the “Voltage Version” chapter.





Overview of Swing-Bucket Rotors Centrifuge 58xx Family



Model	Rotor S-4-104	Rotor A-4-81	Rotor A-4-62
Max. capacity 5804/5804 R	4 × 750 mL	4 × 500 mL	4 × 250 mL
5810/5810 R	■	■	■
Description	Medium capacity swing-bucket rotor for blood, bacteria, cell culture and plate centrifugation	Medium capacity swing-bucket rotor for blood, bacteria, cell culture and plate centrifugation	Economic swing-bucket rotor for blood, bacteria, cell culture and plate centrifugation
Aerosol-tightness tubes/plates	yes/yes	yes/no	yes/no
Max. RCF	3,214 × g	3,220 × g	3,220 × g
Max. speed	3,900 rpm	4,000 rpm	4,000 rpm
Eppendorf Tubes® 5.0 mL and 15 mL conical	56	48	36
25 mL snap cap tubes	24	20	12
25 mL screw cap tubes	28	20	12
50 mL conical tubes	28	20/28 ¹⁾	16
13 mm round-bottom and blood collection tubes	92	100	60
16 mm round-bottom and blood collection tubes	80	64	48
1.5/2.0 mL micro tube	200	80	64
PCR plates/MTP	16	16	16
Deepwell plates (DWP)	4	4	4

¹⁾ Maximum capacity with dedicated bucket/adaptor. ²⁾ Maximum capacity with dedicated 50 mL bucket.

Overview of Fixed-Angle Rotors Centrifuge 58xx Family



Model	Rotor F-34-6-38	Rotor FA-45-6-30
Max. capacity 5804/5804 R	6 × 85 mL	6 × 50 mL
5810/5810 R	■	■
Description	High-speed rotor suitable for molecular applications in tubes up to 85 mL	Aerosol-tight high-speed rotor for safe centrifugation of hazardous samples
Aerosol-tightness	no	yes
Max. RCF	18,514 × g	20,133 × g
Max. speed	12,000 rpm	12,100 rpm
1.5/2.0 mL micro tube	24	–
Eppendorf Tubes® 5.0 mL and 15 mL conical	6	6
50 mL conical tubes	6	6
25 mL conical tubes	6 ¹⁾²⁾	6 ²⁾³⁾
85 mL Oakridge tubes	6	–

¹⁾ Screw cap tubes only. ²⁾ Please order adapter for 25 mL conical tubes screw cap 5820734000. ³⁾ Please order adapter for 25 mL conical tubes snap cap 5820733004.

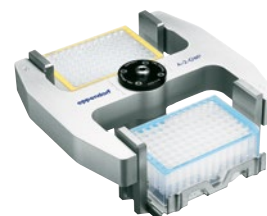

Rotor S-4-72	Rotor A-4-44	Rotor A-2-DWP-AT	Rotor A-2-DWP
4 × 250 mL	4 × 100 mL	2 × 4 MTP, 2 × 1 DWP	2 × 4 MTP, 2 × 2 DWP
■	■	■	■
Economic swing-bucket rotor for blood, bacteria, cell culture centrifugation	High-speed swing-bucket rotor for platelet poor plasma, blood, bacteria and cell culture	Aerosol-tight deepwell plate rotor for safe centrifugation of hazardous samples.	Economic deepwell plate rotor
no/-	yes/-	-/yes	-/no
3,234 × g	4,500 × g	3,486 × g	2,250 × g
4,200 rpm	5,000 rpm	4,500 rpm	3,700 rpm
32	16	-	-
16	4	-	-
16	4	-	-
16	4/8 ²⁾	-	-
56	36	-	-
52	28	-	-
104	48	48	48
-	-	8	8
-	-	2	4



Rotor FA-45-20-17	Rotor FA-45-48-11	Rotor F-45-30-11/Rotor FA-45-30-11
20 × 5.0 mL	48 × 1.5/2.0 mL	30 × 1.5/2.0 mL
■	■	■
Aerosol-tight applications in Eppendorf Tubes® 5.0 mL	Aerosol-tight microcentrifuge tube rotor for safe centrifugation of hazardous samples	Microcentrifuge tube rotor
yes	yes	no/yes
20,913 × g	19,083 × g	20,817 × g
13,100 rpm	13,000 rpm	14,000 rpm
20	48	30
20/-	-	-
-	-	-
-	-	-
-	-	-





Rotors for Centrifuge 58xx Family



Model	Rotor F-35-48-17 ¹⁾	Rotor T-60-11	Rotor F-45-48-PCR
Max. capacity		60 × 1.5/2.0 mL	6 × 5/8 PCR strips (48 × 0.2 mL)
5804/5804 R	■		■
5810/5810 R	■	■	■
Aerosol-tightness	no	no	no
Max. RCF	5,005 × g	16,435 × g	15,294 × g
Max. speed	5,500 rpm	14,000 rpm	12,000 rpm
1.5/2.0 mL micro tube	–	60	–
Eppendorf Tubes® 5.0 mL and 15 mL conical	-/40	–	–

¹⁾ Please note that a software upgrade will be necessary for older centrifuges when using this rotor. Please contact your local Eppendorf organization or dealer for further information.

Ordering information

Description	Order no.
Rotor FA-45-20-17, incl. rotor lid, for 20 Eppendorf Tubes® 5.0 mL	5820765003
Adapter, for 1 vessel 1.5 – 2.0 mL, for all 5.0 mL rotors, 4 pcs.	5820768002
Adapter, for 1 cryo tube, for all 5.0 mL rotors, 4 pcs.	5820769009
Adapter, for 1 HPLC tube, for all 5.0 mL rotors, 4 pcs.	5820770007
Rotor FA-45-48-11, aerosol-tight, incl. rotor lid, for 48 × 1.5/2.0 mL tubes	5820760001
Rotor F-45-30-11, incl. rotor lid, for 30 × 1.5/2.0 mL reaction vessels	5804715004
Rotor FA-45-30-11, aerosol-tight, incl. rotor lid, for 30 × 1.5/2.0 mL reaction vessels	5804726006

Ordering information

Description	Order no.
Rotor F-35-48-17, for 24 × 15 mL conical tubes, incl. 24 steel sleeves and adapters	5820771003
Rotor F-35-48-17, for 40 × 15 mL conical tubes, incl. 48 steel sleeves and adapters	5820772000
Rotor T-60-11, incl. rotor lid, for 1.5/2.0 mL tubes, without adapter	5804730003
Adapter, for 10 reaction vessels 1.5/2.0 mL, for Rotor T-60-11, 6 pcs.	5804731000
Adapter, for 20 reaction vessels 0.4 mL, for Rotor T-60-11, 6 pcs.	5804732006
Rotor F-45-48-PCR, for 6 × 8, 6 × 5 PCR tube strips, 48 × 0.2 mL individual PCR tubes	5804735005

**Rotor A-2-DWP**

- > For use in Centrifuge 5804/5804 R and 5810/5810 R
- > Max. speed: 2,250 × g (3,700 rpm)
- > Rotor can handle up to
 - 2 × 4 MTP
 - 2 × 4 Cell culture plates
 - 2 × 2 DWP
 - 2 × 1 Filtration plate kits

**Rotor A-2-DWP-AT**

- > For use in Centrifuge 5810/5810 R only¹⁾
- > Max. speed: 3,486 × g (4,500 rpm)
- > Rotor can handle up to
 - 2 × 4 MTP
 - 2 × 1 DWP
 - 2 × 1 Filtration plate kits
 - 2 × 2 Cell culture plates

¹⁾ Please note that a software upgrade may be necessary for older centrifuges when using Rotor A-2-DWP-AT. Please contact your local Eppendorf organization or dealer for further information.

Ordering information

Description	Order no.
Rotor A-2-DWP , for Deepwell plates, incl. 2 buckets	5804740009
Rotor A-2-DWP-AT , incl. 2 buckets, 2 aerosol-tight caps and 2 plate carriers	5820710004

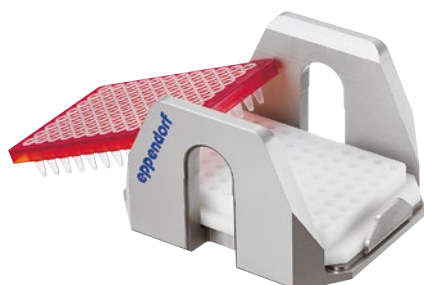
**PCR plate adapter**

- > Adapter is designed to support thin-walled PCR plate wells during centrifugation
- > Available for 96-well and 384-well PCR plates
- > Can be used in all Eppendorf plate rotors

**Cell culture flask adapter**

- > Adapter to spin down cell cultures directly in a cell culture flask
- > Suitable for 25 cm² and selective 75 cm² flasks (please ask for details)
- > Can be used in Eppendorf plate rotor A-4-81-MTP/Flex

**IsoRack adapter**

- > IsoRack adapters to support 1.5/2.0 mL IsoRacks during centrifugation
- > Can be used in Eppendorf plate rotors A-2-DWP and A-4-81-MTP/Flex

Ordering information

Description	Order no.
Adapter , for 1 cell culture flask, for Rotors A-4-81-MTP/Flex	5825719000
Adapter , for 1 PCR plate (96 wells), for 96-well PCR plates, used in A-4-81-MTP/Flex, A-4-62-MTP, A-2-DWP-AT and A-2-DWP, 2 pcs.	5825711009
Adapter , for 1 PCR plate (384 wells), for 384-well PCR plates, used in A-4-81-MTP/Flex, A-4-62-MTP, A-2-DWP-AT and A-2-DWP, 2 pcs.	5825713001
IsoRack adapter , for 24 vessels in the IsoRack 1.5/2.0 mL, for Rotor A-4-81 (MTP), for Rotor A-2-DWP-AT, for 24 × 1.5/2.0 mL tubes in the IsoRack, 2 pcs.	5825709004
CombiSlide Adapter , for 12 slides Combi Slide, for Rotors A-2-MTP and A-4-81 (MTP), 2 pcs.	5825706005





Rotors for Centrifuge 5810 and 5810 R



Rotor S-4-104

- > Medium capacity swing-bucket rotor with max. speed $3,214 \times g$ ($3,900 \text{ rpm}$)¹⁾
- > Broad range of adapters enables high versatility for tubes and bottles from 0.2 mL to 750 mL and plates
- > Aerodynamic round bucket design for up to 36 % energy savings compared to Rotor A-4-81

¹⁾Please note that a software upgrade may be necessary for older centrifuges when using this rotor. Please contact your local Eppendorf organization or dealer for further information.

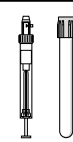
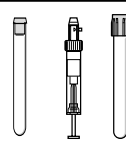
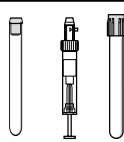

Adapters for Rotor S-4-104









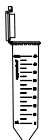

Tube Volume	1.5/2.0 mL	12 x 75 mm, 5 mL FACS	2.6 – 8 mL	5.5 – 12 mL	9 mL	14 mL	Eppendorf Tubes® 5.0 mL and 15 mL conical
Max. tube diameter	11 mm	12 mm	13 mm	16 mm	17.5 mm	17.5 mm	17 mm
Max. vessel height	39 mm	115 mm	115 mm	119 mm	111 mm	117 mm	125 mm
Max. vessel height for use with cap/lid ¹⁾	39 mm	108 mm	108 mm	114 mm	106 mm	112 mm	121 mm
Adapter							
Number of vessels per adapter/rotor	50/200	27/108	23/92	20/80	20/80	14/56	14/56
Bottom shape	flat	round	round	round	round	round	conical
Centrifugation radius	188 mm	183 mm	179 mm	180 mm	179 mm	185 mm	188 mm
Max. RCF	$3,197 \times g$	$3,112 \times g$	$3,044 \times g$	$3,061 \times g$	$3,044 \times g$	$3,146 \times g$	$3,197 \times g$
Packing	2 pcs.	2 pcs.	2 pcs.	2 pcs.	2 pcs.	2 pcs.	2 pcs.
Order no.	5825740009	5825747003	5825738004	5825736001	5825743008	5825748000	5825734009

¹⁾ Exceeding the maximum tube length may reduce the loading capacity of the rotor. Please perform a manual swing-out test before starting the centrifuge run to make sure the tubes do not hit the rotor yoke. ²⁾ Please order adapter for 25 mL conical tubes snap cap 5820733004. ³⁾ Please order adapter for 25 mL conical tubes screw cap 5820734000. ⁴⁾ Please note that these conical bottles need to be used together with a conical form insert provided by the manufacturer. ⁵⁾ 225 mL conical bottles from BD®/Corning® and 250 mL conical bottles from Nunc® for Rotor S-4-104 and S-4x750.

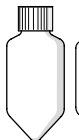

Ordering information

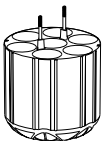
Description	Order no.
Rotor S-4-104	
incl. 4 x 750 mL round buckets	5820740000
aerosol-tight capable, incl. 4 plate buckets	5820754001
without buckets	5820755008
Inlay for microfluidic card , for Rotor S-4-104, 4 pcs.	5820751002
Plate carrier , Rotoren S-4-104, S-4x750, 2 pcs.	5820756004
Plate bucket , for Rotor S-4-104, aerosol-tight capable, incl. plate carrier, 2 pcs.	5820744006
Plate bucket , for Rotor S-4-104, aerosol-tight capable, incl. plate carrier, 4 pcs.	5820743000
Plate bucket (open) , for Rotor S-4-104, incl. plate carrier, 4 pcs.	5820757000
Round bucket 750 mL , for Rotor S-4-104, 2 pcs.	5820742003
Round bucket 750 mL , for Rotor S-4-104, aerosol-tight capable, 4 pcs.	5820741007
Caps , rotors S-4-104, S-4x750, plate bucket, aerosol-tight, 2 pcs.	5820748001
Caps for 750 mL/1000 mL , for rotors S-4-104, S-4x750, S-4x1000, aerosol-tight, 2 pcs.	5820747005
Wide-neck bottle 750 mL , for Rotors S-4-104, S-4x750, S-4x1000, 2 pcs.	5820708000

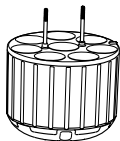
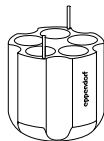
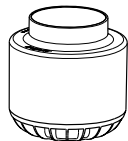
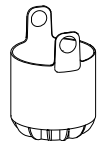
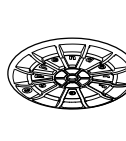
								
25 mL snap cap ²⁾	25 mL screw cap ³⁾	50 mL screw cap	45 mL snap cap	30 mL	50 mL conical, skirted	250 mL flat, 175 – 225/250 mL conical ⁴⁾⁽⁵⁾	500 mL Corning®	750 mL
30 mm	30 mm	30 mm	30 mm	25 mm	30 mm	62 mm	96 mm	102 mm
83 mm	78.5 mm	122 mm	122 mm		120 mm	145 mm	147 mm	140 mm
83 mm	78.5 mm	116 mm	116 mm		116 mm	125 mm	–	–
								
6/24	7/28	7/28	6/24	8/32	5/20	1/4	1/4	1/4
	conical			flat	conical, skirted	flat	conical	flat
161 mm	151 mm	187 mm	187 mm		178 mm	183 mm	187 mm	185 mm
2,737 x g	2,567 x g	3,180 x g	3,180 x g		3,027 x g	3,112 x g	3,180 x g	3,146 x g
	2 pcs.			2 pcs.	2 pcs.	2 pcs.	2 pcs.	2 pcs.
	5825733002			5825755006	5825732006	5825741005	5825745000	5825744004

















Rotors for Centrifuge 5810 and 5810 R

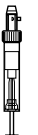

Rotor A-4-81

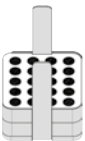
- > Swing-bucket rotor with max. speed $3,220 \times g$ (4,000 rpm)
- > Rotor A-4-81 accommodates tubes and bottles from 0.2 mL to 500 mL as well as plates
- > Aerosol-tight caps¹⁾ for safe centrifugation of hazardous samples optionally available

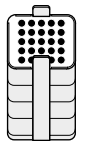
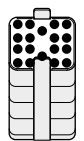
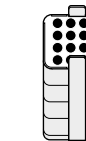
¹⁾ Aerosol-tightness tested by Public Health England, Porton Down, UK.

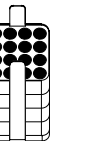
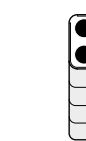
									
Adapters for Rotor A-4-81									
Tube Volume	1.5/2.0 mL	1.2 – 5 mL	2.6 – 5 mL	2.6 – 7 mL	3 – 15 mL	7 – 17 mL	Eppendorf Tubes® 5.0 mL and 15 mL conical tubes	25 mL snap cap	25 mL screw cap
Max. tube diameter	11 mm	11 mm	13 mm	13 mm	16 mm	17.5 mm	17 mm	30 mm	30 mm
Max. vessel height	43 mm	108 mm	108 mm	108 mm	108 mm	118 mm	121 mm	83 mm	78.5 mm
Max. vessel height for use with cap/lid¹⁾	43 mm	108 mm	107 mm	108 mm	108 mm	118 mm	121 mm	116 mm	78.5 mm
Adapter									
Number of vessels per adapter/rotor	20/80	20/80	25/100	18/72	16/64	16/64	12/48	5/20	5/20
Bottom shape	flat	flat	flat with rubber mat	flat with rubber mat	flat with rubber mat	flat with rubber mat	conical	conical	
Centrifugation radius	165 mm	168 mm	168 mm	168 mm	168 mm	168 mm	173 mm	158 mm	148 mm
Max. RCF	$2,950 \times g$	$3,000 \times g$	$3,000 \times g$	$3,000 \times g$	$3,000 \times g$	$3,000 \times g$	$3,100 \times g$	$2,826 \times g$	$2,647 \times g$
Packing	2 pcs.	2 pcs.	2 pcs.	2 pcs.	2 pcs.	2 pcs.	2 pcs.	2 pcs.	
Order no.	5810745004	5810746000	5810720001	5810747007	5810748003	5810721008	5810722004	5810723000	

















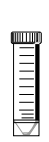

¹⁾ Exceeding the maximum tube length may reduce the loading capacity of the rotor. Please perform a manual swing-out test before starting the centrifuge run to make sure the tubes do not hit the rotor yoke.

²⁾ Please order adapter for 25 mL conical tubes snap cap 5820733004. ³⁾ Please order adapter for 25 mL conical tubes screw cap 5820734000. ⁴⁾ Please order adapter for 50 mL conical tubes skirted 5804737008 or 022654373 for U.S. and Canada. ⁵⁾ Please note that these conical bottles need to be used together with a conical form insert provided by the manufacturer.

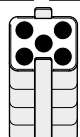
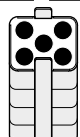

Ordering information

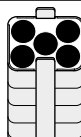
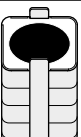
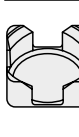
Description	Order no.
Rotor A-4-81 , for 500 mL rectangular buckets or MTP/Flex buckets, incl. 4 x 500 mL rectangular buckets	5810718007
Rotor A-4-81 , without buckets	5810743001
Rotor A-4-81-MTP/Flex , Swing-bucket rotor, incl. 4 MTP/Flex buckets	5810725003
Bucket for 7 x 50 mL conical tubes , for Rotor A-4-81, 4 pcs.	5825730003
Rectangular bucket 500 mL , for Rotor A-4-81, 4 pcs.	5810730007
Cap , aerosol-tight, for 500 mL rectangular bucket, 2 pcs.	5810724007
Wide-neck bottle 500 mL , for Rotors A-4-81, S-4x500, rectangular, 2 pcs.	5820707003
Wide-neck bottle 400 mL , for Rotors A-4-81, S-4x500, 400 mL, lid blue, 2 pcs.	5810729009
MTP/Flex buckets , for Rotors A-4-81, S-4x500, for use with IsoRack and cell culture flask adapters as well as MTP and DWP, 2 pcs.	5810742005
MTP/Flex buckets , for Rotors A-4-81, S-4x500, for use with IsoRack and cell culture flask adapters as well as MTP and DWP, 4 pcs.	5810741009

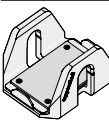
											
50 mL screw cap	45 mL snap cap	25 mL snap cap ²⁾	25 mL screw cap ³⁾	50 mL screw cap	45 mL snap cap	30 – 50 mL round- bottom/50 mL conical, skirted ⁴⁾	180 – 250 mL flat/ 175 – 225 mL conical ⁵⁾	400 mL	500 mL	MTP, DWP, PCR plates	
30 mm	30 mm	30 mm	30 mm	30 mm	30 mm	30 mm	62 mm	133 mm	83 mm	–	
122 mm	122 mm	83 mm	78.5 mm	122 mm	122 mm	121 mm	133 mm	133 mm	134 mm	60 mm	
116 mm	116 mm	–	–	–	–	–	–	–	134 mm	–	
											
5/20	5/20	7/28	7/28	7/28	7/28	5/20	1/4	1/4	–/4	4/16 (MTP) 1/4 (DWP)	
conical	conical	conical	conical	conical	conical	flat with rubber mat	flat with rubber mat	flat, rubber	flat	flat with rubber mat	
173 mm	173 mm	155 mm	145 mm	180 mm	180 mm	173 mm	173 mm	180 mm	180 mm	163 mm	
3,100 x g	3,100 x g	2,772 x g	2,593 x g	3,220 x g	3,220 x g	3,100 x g	3,100 x g	3,220 x g	3,220 x g	2,900 x g	
2 pcs.	2 pcs.	4 pcs.	4 pcs.	4 pcs.	4 pcs.	2 pcs.	2 pcs.	2 pcs.	–	2 pcs.	
5810723000	5810723000	5825730003	5825730003	5825730003	5825730003	5810739004	5825722000	5810728002	–	5810742005	







Rotors for Centrifuge 5810 and 5810 R



Rotor A-4-62

- > Swing-bucket rotor with max. speed $3,220 \times g$ (4,000 rpm)
- > Rotor A-4-62 accommodates tubes and bottles from 0.2 mL to 250 mL as well as plates
- > Aerosol-tight caps¹⁾ for safe centrifugation of hazardous samples optionally available

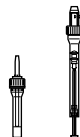
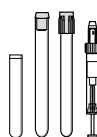
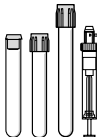
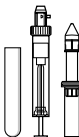
¹⁾ Aerosol-tightness tested by Public Health England, Porton Down, UK.

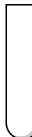
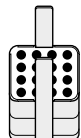
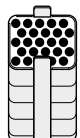
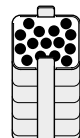
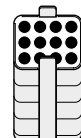
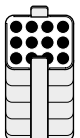
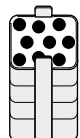
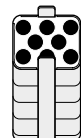
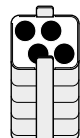
								
Adapters for Rotor A-4-62								
Tube Volume	1.5 – 2.0 mL	1.2 – 5 mL	2.6 – 7 mL	3 – 15 mL	7 – 17 mL	Eppendorf Tubes® 5.0 mL and 15 mL conical	7 – 18 mL	18 – 25 mL
Max. tube diameter	11 mm	11 mm	13 mm	16 mm	17.5 mm	17 mm	20 mm	26 mm
Max. vessel height	43 mm	123 mm	121 mm	121 mm	118 mm	127 mm	126 mm	119 mm
Max. vessel height for use with cap/lid¹⁾	43 mm	115 mm	118 mm	116 mm	114 mm	121 mm	119 mm	116 mm
Adapter								
Number of vessels per adapter/rotor	16/64	25/100	15/60	12/48	12/48	9/36	8/32	4/16
Bottom shape	flat	flat with rubber mat	flat with rubber mat	flat with rubber mat	flat with rubber mat	conical	flat with rubber mat	flat with rubber mat
Centrifugation radius	171 mm	173 mm	173 mm	173 mm	173 mm	178 mm	173 mm	173 mm
Max. RCF	$3,000 \times g$	$3,050 \times g$	$3,050 \times g$	$3,050 \times g$	$3,050 \times g$	$3,150 \times g$	$3,050 \times g$	$3,050 \times g$
Packing	2 pcs.	2 pcs.	2 pcs.	2 pcs.	2 pcs.	2 pcs.	2 pcs.	2 pcs.
Order no.	5810751004	5810750008	5810752000	5810753007	5810754003	5810755000	5810756006	5810757002











¹⁾ Exceeding the maximum tube length may reduce the loading capacity of the rotor. Please perform a manual swing-out test before starting the centrifuge run to make sure the tubes do not hit the rotor yoke.

²⁾ Please order adapter for 50 mL conical tubes skirted 5804 737008.

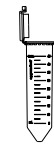
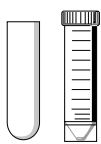

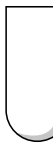
Ordering information

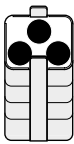
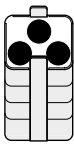
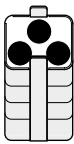
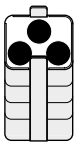
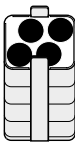
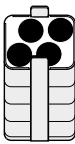
Description	Order no.
Rotor A-4-62 , incl. 4 × 250 mL rectangular buckets	5810709008
Rotor A-4-62-MTP , with 4 MTP buckets	5810711002
MTP bucket for Rotor A-4-62 , for 4 MTP or 1 DWP, 4 pcs.	5810702003
Caps , for rectangular bucket 250 mL, aerosol-tight, 2 pcs.	5810710006
Rectangular bucket 250 mL , for Rotor A-4-62, 4 pieces	5810716004

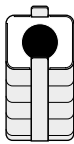
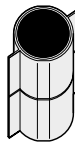
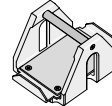
										
25 mL snap cap	25 mL screw cap	50 mL screw cap	45 mL snap cap	50 mL screw cap	45 mL snap cap	30 – 50 mL round-bottom/ 50 mL conical, skirted ²⁾	50 – 75 mL	80 – 120 mL	200 – 250 mL flat/ 175 – 225 mL conical	MTP, DWP, PCR plates
30 mm	30 mm	30 mm	30 mm	30 mm	30 mm	30 mm	35 mm	45 mm	62 mm	–
83 mm	78.5 mm	122 mm	119 mm	122 mm	122 mm	115 mm	122 mm	138 mm	136 mm	53 mm
83 mm	78.5 mm	116 mm	116 mm	–	–	–	118 mm	125 mm	127 mm	–
										
3/12	3/12	3/12	3/12	4/16	4/16	4/16	2/8	1/4	1/4	4/16 (MTP) 1/4 (DWP)
conical				flat with conical inlay		flat with rubber mat	flat with rubber mat	flat with rubber mat	flat with rubber mat	flat with rubber mat
151 mm	141 mm	178 mm	173 mm	173 mm	173 mm	173 mm	173 mm	173 mm	180 mm	154 mm
2,701 × g	2,522 × g	3,150 × g	3,050 × g	3,050 × g	3,050 × g	3,050 × g	3,050 × g	3,050 × g	3,220 × g	2,750 × g
2 pcs.				2 pcs.		2 pcs.	2 pcs.	2 pcs.	2 pcs.	4 pcs.
5810758009				5810763002		5810759005	5810760003	5810761000	5810770009	5810702003









Rotors for Centrifuge 58xx Family



Rotor S-4-72

- > Medium capacity swing-bucket rotor with speeds up to $3,234 \times g$ ($4,200 \text{ rpm}$)¹⁾
- > Broad range of adapters available to handle all common tube formats from 0.2 mL to 250 mL
- > Aerodynamic round bucket design for up to 48 % energy savings compared to Rotor A-4-62

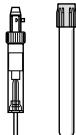
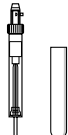
¹⁾ Please note that a software upgrade may be necessary for older centrifuges when using this rotor. Please contact your local Eppendorf organization or dealer for further information.

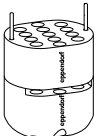
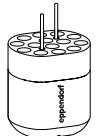
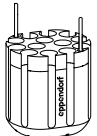
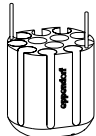
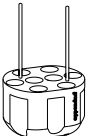







					
Adapters for Rotor S-4-72					
Tube Volume	1.5/2.0 mL	2.6 – 8 mL	5.5 – 12 mL	9 mL	Eppendorf Tubes® 5.0 mL
Max. tube diameter	11 mm	13 mm	16 mm	17.5 mm	17 mm
Max. vessel height	43 mm	115 mm	112 mm	113 mm	60 mm
Adapter					
Number of vessels per adapter/rotor	26/104	14/56	13/52	12/48	8/32 ¹⁾
Bottom shape	flat	round	round	round	conical
Centrifugation radius	159 mm	159 mm	157 mm	158 mm	163 mm
Max. RCF	$3,136 \times g$	$3,136 \times g$	$3,096 \times g$	$3,116 \times g$	$3,215 \times g$
Packing	2 pcs.	2 pcs.	2 pcs.	2 pcs.	2 pcs.
Order no.	5804794001	5804789008	5804791002	5804792009	5804793005

¹⁾ For Eppendorf Tubes® 5.0 mL with screw cap the capacity is limited to 6 tubes per adapter.²⁾ Please order adapter for 25 mL conical tubes snap cap 5820733004.³⁾ Please order adapter for 25 mL conical tubes screw cap 5820734000.⁴⁾ Please note that these conical bottles need to be used together with a conical form insert provided by the manufacturer.

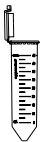

Ordering information

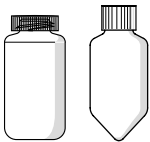
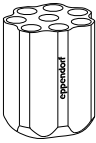
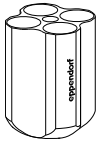
Description	Order no.
Rotor S-4-72, incl. 4 × 250 mL round buckets	5804746007

						
15 mL conical	25 mL snap cap ²⁾	25 mL screw cap ³⁾	50 mL screw cap	45 mL snap cap	50 mL conical, skirted	250 mL flat/ 175 mL Falcon ^{®4)}
17 mm	30 mm	30 mm	30 mm	30 mm	30 mm	62 mm
120 mm	83 mm	78.5 mm	120 mm	83 mm	120 mm	130 mm
						
8/32	4/16	4/16	4/16	4/16	2/8	1/4
conical			conical		conical	flat
164 mm	137 mm	128 mm	164 mm	137 mm	153 mm	160 mm
3,234 × g	2,701 × g	2,524 × g	3,234 × g	2,701 × g	2,602 × g	3,155 × g
2 pcs.			2 pcs.		2 pcs.	2 pcs.
5804783000			5804784006		5804785002	5804787005











Rotors for Centrifuge 58xx Family

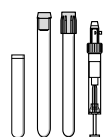
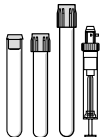
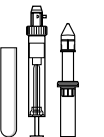
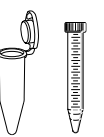

Rotor A-4-44

- > High-speed swing-bucket rotor for applications up to 4,500 × g (5,000 rpm)
- > Rotor A-4-44 accommodates tubes from 0.2 mL to 100 mL
- > Aerosol-tight caps¹⁾ for safe centrifugation of hazardous samples optionally available

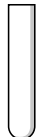
¹⁾ Aerosol-tightness tested by Public Health England, Porton Down, UK.

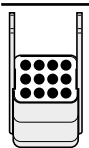
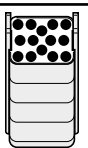
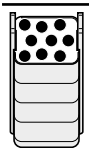
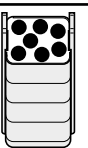
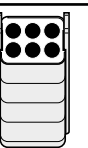
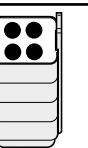
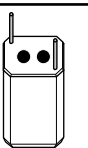
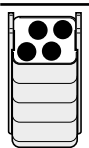
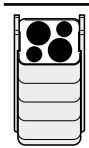
									
Adapters for Rotor A-4-44									
Tube Volume	1.5 – 2.0 mL	1.2 – 5 mL	2.6 – 7 mL	3 – 15 mL	7 – 17 mL	Eppendorf Tubes® 5.0 mL and 15 mL conical	15 mL conical	7 – 18 mL	18 – 30 mL
Max. tube diameter	11 mm	11 mm	13 mm	16 mm	17.5 mm	17 mm	17 mm	20 mm	26 mm
Max. vessel height	43 mm	105 mm	108 mm	108 mm	110 mm	121 mm	121 mm	107 mm	110 mm
Max. vessel height for use with cap/lid¹⁾	43 mm	102 mm	106 mm	106 mm	106 mm	–	121 mm	104 mm	100 mm
Adapter									
Number of vessels per adapter/rotor	12/48	14/56	9/36	7/28	6/24	4/16	2/8	4/16	2/8
Bottom shape	flat	flat with rubber mat	flat with rubber mat	flat with rubber mat	flat with rubber mat	conical	conical	flat with rubber mat	flat with rubber mat
Centrifugation radius	148 mm	150 mm	150 mm	150 mm	150 mm	155 mm	157 mm	150 mm	150 mm
Max. RCF	4,100 × g	4,200 × g	4,200 × g	4,200 × g	4,200 × g	4,332 × g	4,388 × g	4,200 × g	4,200 × g
Packaging	2 pcs.	2 pcs.	2 pcs.	2 pcs.	2 pcs.	2 pcs.	2 pcs.	2 pcs.	2 pcs.
Order no.	5804751000	5804750004	5804752007	5804753003	5804754000	5804755006	5804717007	5804756002	5804757009

¹⁾ Exceeding the maximum tube length may reduce the loading capacity of the rotor. Please perform a manual swing-out test before starting the centrifuge run to make sure the tubes do not hit the rotor yoke.

²⁾ Please order adapter for 25 mL conical tubes snap cap 5820733004.³⁾ Please order adapter for 25 mL conical tubes screw cap 5820734000.



Ordering information

Description	Order no.
Rotor A-4-44 , incl. 4 × 100 mL rectangular buckets	5804709004
Bucket for 2 × 50 mL conical tubes , for Rotor A-4-44, 4 pcs.	5804706005
Rotor A-4-44 , incl. 4 buckets for 2 × 50 mL conical tubes	5804719000
Rectangular bucket 100 mL , for Rotor A-4-44, 4 pcs.	5804741005
Caps , for 100 mL rectangular bucket, aerosol-tight, 2 pcs.	5804712005
Adapter Insert , insert for 50 mL conical tubes with skirted bottom, 8 pcs.	5804737008

25 mL snap cap	25 mL screw cap	50 mL screw cap	45 mL snap cap	25 mL snap cap ²⁾	25 mL screw cap ³⁾	50 mL screw cap	45 mL snap cap	30 – 50 mL round- bottom/ 50 mL conical, skirted	50 mL screw cap	45 mL snap cap	50 – 75 mL	80 – 100 mL	
30 mm	30 mm	30 mm	30 mm	30 mm	30 mm	30 mm	30 mm	30 mm	–	–	35 mm	45 mm	
83 mm	78.5 mm	122 mm	122 mm	83 mm	78.5 mm	122 mm	122 mm	122 mm	120 mm	120 mm	119 mm	114 mm	
83 mm	78.5 mm	–	–	83 mm	78.5 mm	119 mm	119 mm	108 mm	–	–	108 mm	100 mm	
1/4	1/4	1/4	1/4	1/4	1/4	1/4	1/4	1/4	–/8	–/8	1/4	1/4	
conical				conical				flat with rubber mat	flat with conical inlay		flat with rubber mat	flat with rubber mat	
124 mm	114 mm	155 mm	155 mm	126 mm	116 mm	157 mm	157 mm	150 mm	161 mm	161 mm	150 mm	150 mm	
3,465 × g	3,186 × g	4,332 × g	4,332 × g	3,521 × g	3,242 × g	4,388 × g	4,388 × g	4,200 × g	4,500 × g	4,500 × g	4,200 × g	4,200 × g	
2 pcs.				2 pcs.				2 pcs.	4 pcs.		2 pcs.	2 pcs.	
5804758005				5804718003				5804759001	5804706005		5804760000	5804761006	













Rotors for Centrifuge 58xx Family



Rotor F-34-6-38

- > For molecular applications in tubes from 0.2 mL to 85 mL
- > Max. speed: 18,514 × g (12,000 rpm) in Centrifuge 5810 R or 15,557 × g (11,000 rpm) in Centrifuge 5804/5804 R/5810¹⁾
- > Low rotor weight (3.2 kg) for easy handling

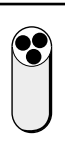
¹⁾ Rotors F-34-6-38 and FA-45-6-30 maintain 4 °C at 11,000 rpm

					
Adapters for Rotor F-34-6-38					
Tube Volume	1.5 – 2.0 mL	2 – 5 mL (13x75 mm)	4 – 7 mL (13x100 mm)	7 – 15 mL	Eppendorf Tubes® 5.0 mL
Max. tube diameter	11 mm	13 mm	13 mm	16 mm	17 mm
Max. vessel height for use with cap/lid	43 mm	80 mm	107 mm	112 mm	–
Adapter					
Number of vessels per adapter/rotor	4/24	3/18	3/18	2/12	1/6
Bottom shape	round	flat	flat	round	conical
Centrifugation radius	113 mm	106 mm	114 mm	112 mm	105 mm
Max. RCF at 12.100 rpm (5810 R)	18,200 × g	17,065 × g	18,353 × g	18,000 × g	17,187 × g
Max. RCF at 11.000 rpm (5804, 5804 R, 5810)	15,300 × g	14,339 × g	15,422 × g	15,150 × g	14,204 × g
Packing	2 pcs.	2 pcs.	2 pcs.	2 pcs.	2 pcs.
Order no.	5804770005	5804738004	5804739000	5804771001	5804777000

















¹⁾ Please order adapter for 25 mL conical tubes screw cap 5820734000.

i For more information go to www.eppendorf.com/centrifugation



Ordering information

Description	Order no.
Rotor F-34-6-38 , for 6 × 85 mL tubes, incl. rotor lid	5804727002
Rotor lid , for F-34-6-38, for Centrifuge 58xx	5804727509

							
15 mL conical	15 – 18 mL	30 mL	25 mL screw cap ¹⁾	50 mL screw cap	45 mL snap cap	50 mL	85 mL
17 mm	18 mm	26 mm	30 mm	30 mm	30 mm	29 mm	38 mm
123 mm	123 mm	123 mm	78.5 mm	117 mm	–	123 mm	121 mm
							
1/6	1/6	1/6	1/4	1/6	1/4	1/6	–/6
conical	round	round		conical		round	round
107 mm	109 mm	110 mm	87 mm	108 mm	108 mm	112 mm	115 mm
17,200 × g	17,550 × g	17,700 × g	14,241 × g	17,400 × g	17,400 × g	18,014 × g	18,500 × g
14,450 × g	14,750 × g	14,900 × g	14,070 × g	14,600 × g	14,600 × g	15,157 × g	15,550 × g
2 pcs.	2 pcs.	2 pcs.		2 pcs.		2 pcs.	
5804776003	5804772008	5804773004		5804775007		5804774000	–





Rotors for Centrifuge 58xx Family



Rotor FA-45-6-30

- > High-speed rotor for applications in tubes from 5 – 50 mL¹⁾
- > Max. speed 20,133 × g (12,100 rpm) in Centrifuge 5810 R or 16,639 × g (11,000 rpm) in Centrifuge 5804/5804 R/5810²⁾
- > Eppendorf QuickLock® rotor lid for fast lid locking

¹⁾ Please note that a software upgrade may be necessary for older centrifuges when using this rotor. Please contact your local Eppendorf organization or dealer for further information.

²⁾ Rotors F-34-6-38 and FA-45-6-30 maintain 4 °C at 11,000 rpm

Ordering information

Description	Order no.
Rotor FA-45-6-30, aerosol-tight, incl. rotor lid, for 6 × 15/50 mL conical tubes	5820715006

Adapters for Rotor FA-45-6-30					
Tube Volume	2.6 – 5 mL	4 – 8 mL	5.5 – 10 mL	7.5 – 12 mL	Eppendorf Tubes® 5.0 mL
Max. tube diameter	13 mm	13 mm	16 mm	16 mm	17 mm
Max. vessel height for use with cap/lid	–	119 mm	–	119 mm	–
Adapter					
Number of vessels per adapter/rotor	1/6	1/6	1/6	1/6	1/6 ¹⁾
Bottom shape	round	round	round	round	conical
Centrifugation radius	120 mm	120 mm	120 mm	120 mm	121 mm
Max. RCF at 12.100 rpm (5810 R)	19,642 × g	19,642 × g	19,642 × g	19,642 × g	19,806 × g
Max. RCF at 11.000 rpm (5804, 5804 R, 5810)	16,233 × g	16,233 × g	16,233 × g	16,233 × g	16,369 × g
Packing	2 pcs.	2 pcs.	2 pcs.	2 pcs.	2 pcs.
Order no.	5820726008	5820725001	5820728000	5820727004	5820730005

¹⁾ Eppendorf Tubes® 5.0 mL with screw cap will not fit in this adapter.



Eppendorf Conical Tubes

Whether you use them for centrifugation, mixing, or other applications – the Eppendorf Conical Tubes 15 mL, 25 mL and 50 mL will perfectly fit into your workflows. They represent the next step in Eppendorf's comprehensive system solutions in liquid, sample and cell handling.

More information: www.eppendorf.link/conicals



7 – 17 mL	15 mL	16 mL	30 mL	25 mL snap cap	25 mL screw cap	50 mL screw cap	45 mL snap cap
17.5 mm	17 mm	18 mm	26 mm	30 mm	30 mm	30 mm	30 mm
112 mm	121 mm	107 mm	104 mm	83 mm	78.5 mm	127 mm	127 mm
1/6	1/6	1/6	1/6	1/6	1/6	-/6	-/6
round	conical	round	round	conical	conical	conical	conical
120 mm	120 mm	120 mm	105 mm	104 mm	97 mm	123 mm	123 mm
19,642 × g	19,642 × g	19,642 × g	17,187 × g	17,023 × g	15,616 × g	19,500 × g	20,133 × g
16,233 × g	16,223 × g	16,223 × g	14,204 × g	14,069 × g	13,122 × g	16,639 × g	16,639 × g
2 pcs.	2 pcs.	2 pcs.	2 pcs.	6 pcs.	6 pcs.	-	-
5820729007	5820717009	5820720000	5820721006	5820733004	5820734000	-	-





Centrifuge 5910 Ri



Description

The refrigerated Centrifuge 5910 Ri combines high capacity and performance in a compact and ergonomic footprint. It comes with an intuitive touchscreen user interface and an advanced temperature management system.

Product features

- > Large 7-inch VisioNize® touch interface for super-fast parameter settings via unique favorites function
- > User management with multiple authorization levels and documentation features supporting GLP/GxP requirements
- > Swing-bucket rotors and adapters for tubes and bottles from 0.2 mL to 1,000 mL as well as all types of MTP, PCR or Deepwell Plates

Ordering information

Description

Centrifuge 5910 Ri, touch interface, refrigerated, without rotor, 230 V/50 – 60 Hz (GB)

Order no.

5943000061

✎ Ordering information for other voltage options can be found in the “Voltage Version” chapter.



www.eppendorf.link/centrifuge5910Ri

Centrifuge 5920 R



Description

Centrifuge 5920 R is a large benchtop refrigerated centrifuge with exceptional performance and high capacity, making it a superior choice for high-throughput applications.

Product features

- > Swing-bucket rotors and adapters accommodate tubes and bottles from 0.2 mL to 1,000 mL
- > Plate rotor options for centrifugation of all types of MTP, PCR or Deepwell Plates
- > Fixed-angle rotors for high-speed molecular biology applications in tubes from 0.2 mL to 50 mL

Ordering information

Description

Centrifuge 5920 R, keypad, refrigerated, without rotor, 230 V/50 – 60 Hz (GB)

Order no.

5948000060

✎ Ordering information for other voltage options can be found in the “Voltage Version” chapter.



www.eppendorf.link/centrifuge5920R



	Centrifuge 5910 Ri	Centrifuge 5920 R
1,000 mL Eppendorf bottles	4	–
1,000 mL standard bottles	–	4
750 mL bottles	4	4
180 – 250 mL bottles (flat)	6	8
50 mL conical tubes	36	52
25 mL conical tubes	36	52
5 mL and 15 mL conical tubes	68	108
1.5/2.0 mL Eppendorf Tubes®	200	368
BD Vacutainer® CPT™ (16 mm × 125 mm/8 mL)	28	80
16 mm round-bottom and blood collection tubes	104	148
13 mm round-bottom and blood collection tubes	120	196
PCR plates/MTP	20	28
Universal adapters for conical tubes, plates and bottles	■	■
Dual use of plates and tubes in one rotor bucket	■	■
Plate rotor options for MTP, PCR or DWP	■	■
Fixed-angle rotors for high-speed applications	■	■

Centrifuge Packages 5910 Ri

Ordering information

Description	Order no.
Centrifuge 5910 Ri , touch interface, refrigerated, High Speed Solution, with Rotor FA-6x50, 230 V/50 – 60 Hz (GB)	5943000157
Centrifuge 5910 Ri , touch interface, refrigerated, with Rotor S-4x750, incl. round buckets and adapters for 5 mL/15 mL/50 mL conical tubes, 230 V/50 – 60 Hz (GB)	5943000561
Centrifuge 5910 Ri , touch interface, refrigerated, with Rotor S-4xUniversal, incl. universal buckets and adapters for 5 mL/15 mL/50 mL conical tubes and plates, 230 V/50 – 60 Hz (GB)	5943000361
Centrifuge 5910 Ri , touch interface, refrigerated, Big Volume Harvesting Solution, with Rotor S-4xUniversal, incl. universal buckets and 1 L adapters (4x), Eppendorf 1 L bottles (4x), 230 V/50 – 60 Hz (GB)	5943000181
Centrifuge 5910 Ri , touch interface, refrigerated, Versatility Solution, with Rotor S-4xUniversal, incl. universal buckets and adapters for 5 mL/15 mL/50 mL conical tubes, 175 – 250 mL bottles and plates, 230 V/50 – 60 Hz (GB)	5943000266
Centrifuge 5910 Ri , touch interface, refrigerated, with Rotor S-4xUniversal, incl. universal buckets, adapters for 5 mL/15 mL/50 mL conical tubes, 175 – 250 mL bottles and plates, adapters for 1000 mL bottles incl. 4 x 1000 mL bottles, 230 V/50 – 60 Hz (GB)	5943000912

✎ Ordering information for other voltage options can be found in the “Voltage Version” chapter.

Centrifuge Packages 5920 R

Ordering information

Description	Order no.
Centrifuge 5920 R , keypad, refrigerated, with Rotor S-4xUniversal-Large, incl. universal buckets and adapters for 5 mL/15 mL/25 mL/50 mL conical tubes and plates, 230 V/50 – 60 Hz (GB)	5948000961
Centrifuge 5920 R , keypad, refrigerated, with Rotor S-4xUniversal-Large, incl. universal buckets and adapters for round-bottom tubes with diameter 13/16 mm, 230 V/50 – 60 Hz (GB)	5948000860
Centrifuge 5920 R , keypad, refrigerated, with Rotor S-4x1000, incl. high-capacity buckets and adapters for 15 mL/50 mL conical tubes, 230 V/50 – 60 Hz (GB)	5948000260
Centrifuge 5920 R , keypad, refrigerated, with Rotor S-4x1000, incl. plate/tube buckets and adapters for 15 mL/50 mL conical tubes, 230 V/50 – 60 Hz (GB)	5948000460
Centrifuge 5920 R , keypad, refrigerated, High-Throughput Screening Solution, with Rotor S-4x1000, incl. plate/tube bucket and plate carrier, 230 V/50 – 60 Hz (GB)	5948000182
Centrifuge 5920 R , keypad, refrigerated, with Rotor S-4x1000, incl. round buckets and adapters for 15 mL/50 mL conical tubes, 230 V/50 – 60 Hz (GB)	5948000365

✎ Ordering information for other voltage options can be found in the “Voltage Version” chapter.





Overview of Swing-Bucket Rotors Centrifuge 59xx Family



Model	Rotor S-4xUniversal-Large	Rotor S-4x1000 high-capacity buckets	Rotor S-4x1000 plate/tube buckets	Rotor S-4x1000 round buckets
Description	Extra high capacity	Extra high capacity	High capacity	Medium capacity, compatible with standard 1 Liter bottle
5910 Ri				
5920 R	■	■	■	■
Universal bucket	yes	no	no	no
Aerosol-tightness	yes	no	yes	yes
Max. capacity	4 × 750 mL	8 × 250 mL	40 × 50 mL	4 × 1,000 mL
Max. RCF	4,402 × g	3,153 × g	3,076 × g	3,428 × g
Max. speed	4,250 rpm	3,700 rpm	3,700 rpm	3,700 rpm
1.5/2.0 mL micro tube	368			200
Eppendorf Tubes® 5.0 mL and 15 mL conical	96	108	88	56
50 mL conical tubes	40	52	40	28
25 mL snap cap tubes	40	48	36	24
25 mL screw cap tubes	40	52	40	28
13 mm round-bottom and blood collection tubes	196	196	140	92
16 mm round-bottom and blood collection tubes	148	144	132	80
750 mL bottles	4			4
1,000 mL Eppendorf bottles				
1,000 mL standard bottles				4
PCR plates/MTP	20	24	28	
Deepwell plates (DWP)	8	8	8	



400 mL



500 mL



750 mL



400 mL



1,000 mL

Eppendorf bottles for Centrifuge 5910 Ri and Centrifuge 5920 R

Bottle Manufacturer	Volume	Order no.	Size Diameter x Height	Bottom shape	Material	S-4x Universal-Large	AT ¹⁾	S-4x1000 Round Bucket	AT ¹⁾
Eppendorf	400 mL	5810729009	80 x 133 mm	flat	PP				
Eppendorf	500 mL	5820707003	83 x 134 mm	flat	PP				
Eppendorf	750 mL	5820708000	102 x 133 mm	flat	PP	■	■	■	■
Eppendorf	400 mL	5910707002	81 x 117 mm	flat	PP				
Eppendorf	1,000 mL	5910770006	118 x 133.1 mm	flat	PP				

¹⁾ Aerosol tight cap possible.



Rotor S-4xUniversal	Rotor S-4x750 with round buckets	Rotor S-4x500	Rotor S-4x400
High capacity and versatility, compatible with Eppendorf 1 Liter bottle	Medium capacity, high speed	Medium capacity	Low capacity, high speed
■	■	■	■
yes	no	no	no
yes	yes	yes	yes
4 x 1,000 mL	4 x 750 mL	4 x 500 mL	4 x 400 mL
4,347 x g	4,800 x g	3,220 x g	5,263 x g
4,500 rpm	4,700 rpm	4,000 rpm	5,100 rpm
68	200	96	104
36	56	48	28
36	28	20	16
36	24	20	16
36	28	20	16
120	92	100	60
104	80	64	44
4	4		
4			
20	16	16	
4	4	4	

Eppendorf bottles for Centrifuge 5910 Ri and Centrifuge 5920 R

S-4x750	AT ¹⁾	S-4xUniversal	AT ¹⁾	S-4x500	AT ¹⁾	S-4x400	AT ¹⁾
				■			
				■	■		
■	■	■				■	■
		■	■				





Rotors for Centrifuge 5910 Ri



Rotor S-4xUniversal

- > High capacity swing-bucket rotor with max. speed $4,347 \times g$ (4,500 rpm)
- > Broad range of adapters enables high versatility for tubes and flasks from 4 mL to 1,000 mL and plates
- > Universal bucket design accommodates both plates and tubes

Ordering information

Description	Order no.
Rotor S-4xUniversal , incl. universal buckets	5895200001
Universal buckets , for Rotor S-4xUniversal, 2 pcs.	5895202004
Universal buckets , for Rotor S-4xUniversal, 4 pcs.	5895203000
Caps , for Rotor S-4xUniversal, aerosol-tight, 2 pcs.	5910750005
Wide-neck bottle 1,000 mL , for Rotor S-4xUniversal, 2 pcs.	5910770006
Wide-neck bottle 750 mL , for Rotors S-4-104, S-4x750, S-4x1000, 2 pcs.	5820708000

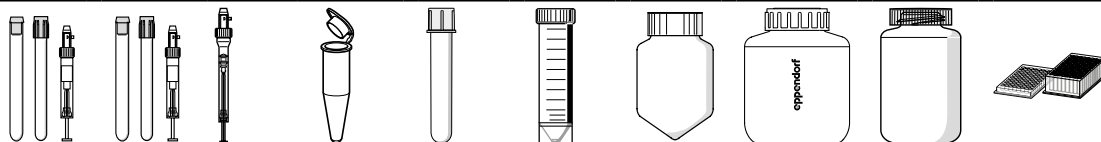

Adapters for Rotor S-4xUniversal

Tube Volume	4 mL – 8 mL	7.5 mL – 12 mL	9 mL	1.5 - 2 mL	12 x 75 mm, 5 mL FACS	50 mL conical, skirted	500 mL Corning®	750 mL	1,000 mL	MTP, DWP, PCR plates
Max. tube diameter	13 mm	16 mm	17.5 mm	11 mm	12 mm	31 mm	96 mm	102 mm	118 mm	–
Max. vessel height	119 mm	120 mm	120 mm	–	112 mm	124 mm	148 mm	139 mm	133 mm	80 mm
Max. vessel height for use with cap/lid¹⁾	117 mm	118 mm	118 mm	43 mm	107 mm	121 mm	–	135 mm	133 mm	66 mm
Adapter										
Number of vessels per adapter/rotor	30/120	26/104	21/84	46/184	46/184	7/28	1/4	1/4	1/4	5/20
Bottom shape	round	round	round	flat	round	flat	conical	flat	flat	flat
Centrifugation radius	190 mm	195 mm	188 mm	187 mm	189 mm	185 mm	187 mm	188 mm	188 mm	170 mm
Max. RCF	$4,302 \times g$	$4,415 \times g$	$4,256 \times g$	$4,233 \times g$	$4,279 \times g$	$4,188 \times g$	$4,234 \times g$	$4,256 \times g$	$4,256 \times g$	$3,849 \times g$
Order no.	5910755007	5910754000	5910762003	5910763000	5910758006	5910764006	5910760000	5910757000	5910756003	5910753004

¹⁾ Please perform a manual test to determine the actual loading capacity.²⁾ Aerosol-tight caps compatible with MTP, DWP 96500 µl, DWP 384200 µl. Aerosol-tight caps not compatible with DWP 961,000 µl and 2,000 µl.³⁾ Please order adapter for 25 mL conical tubes snap cap 5820733004.⁴⁾ When used with aerosol-tight caps the max. capacity is reduced to 20 x 50 mL (5 x 50 mL per adapter).⁵⁾ Please order adapter for 25 mL conical tubes screw cap 5820734000.⁶⁾ Please note that these conical bottles need to be used together with a conical form insert provided by the manufacturer.



Universal Adapters for Rotor S-4xUniversal

Rotor S-4xUniversal brings outstanding versatility to those customers who need to spin a variety of vessels and plates. Three innovative universal adapters accommodate a selection of tubes, plates and bottles:

- > Adapter 1: 5.0 mL and 15 mL conical tubes, MTP/DWP
- > Adapter 2: 25 mL and 50 mL conical tubes, MTP
- > Adapter 3: 25 mL and 50 mL conical tubes, 250 mL bottles, MTP

For customers who need either stacking capability, higher speed or aerosol-tight centrifugation of certain plate formats, a separate plate carrier is available.

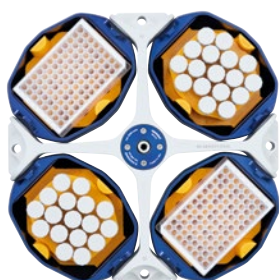

Universal adapter 1
Setup for deepwell plates and
Eppendorf Tubes® 5.0/15 mL.



Universal adapter 2
Setup for microplates and 25/50 mL conical
tubes.

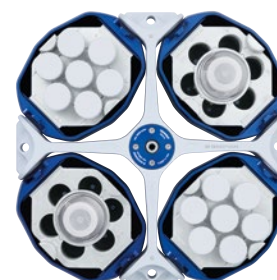

Universal adapter 3
Setup for 25/50 mL conical tubes, 250 mL
bottles and microplates.

Eppendorf Tubes® 5.0 mL	15 mL conical	MTP, DWP	25 mL snap cap ³⁾	25 mL screw cap ⁵⁾	50 mL screw cap	50 mL screw cap	25 mL snap cap ³⁾	25 mL screw cap ⁵⁾	50 mL screw cap	45 mL snap cap	Microplate 96/384 wells	250 mL flat, 175 - 225 mL conical ⁶⁾
17 mm	17 mm	–	30 mm	30 mm	30 mm	–	30 mm	30 mm	30 mm	30 mm	–	62 mm
124 mm	124 mm	64 mm	83 mm	78.5 mm	116 ⁴⁾ mm	16 mm	83 mm	78.5 mm	124 mm	133 mm	16 mm	146 mm
122 mm	122 mm	²⁾	83 ⁴⁾ mm	78.5 ⁴⁾ mm	116 ⁴⁾ mm	–	83 mm	78.5 mm	121 mm	133 mm	–	139 mm
17/68	17/68	1/4	9/36	9/36	9/36	1/4	7/28	7/28	7/28	7/28	1/4	1/4
conical	conical	flat	conical	conical	conical	flat	conical	conical	conical	conical	flat	flat
191 mm	191 mm	143 mm	107 mm	156 mm	192 mm	115 mm	107 mm	155 mm	191 mm	188 mm	115 mm	187 mm
4,324 × g	4,324 × g	3,237 × g	3,758 × g	3,531 × g	4,347 × g	2,604 × g	3,735 × g	3,509 × g	4,324 × g	4,256 × g	2,604 × g	4,234 × g
5910752008			5910769008				5910751001					





Rotors for Centrifuge 5910 Ri





Rotor S-4x500

- > Medium capacity swing-bucket rotor with max. speed 3,220 × g (4,000 rpm)
- > Rotor S-4x500 accommodates tubes and bottles from 0.2 mL to 500 mL as well as plates
- > Aerosol-tight caps for safe centrifugation of hazardous samples optionally available¹⁾

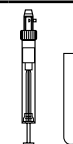
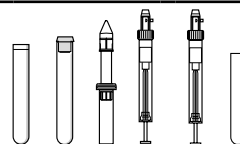
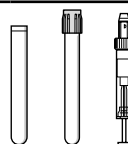
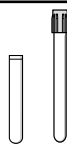
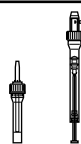
¹⁾ Aerosol-tightness tested by Public Health England, Porton Down, UK.

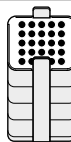
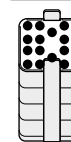
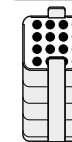
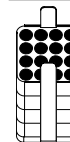
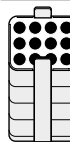

Adapters for Rotor S-4x500

Tube Volume	1.5/2.0 mL	1.2 – 5 mL	2.6 – 5 mL	2.6 – 7 mL	3 – 15 mL	7 – 17 mL	Eppendorf Tubes® 5.0 mL and 15 mL conical tubes
Max. tube diameter	11 mm	11 mm	13 mm	13 mm	16 mm	17.5 mm	17 mm
Max. vessel height	43 mm	108 mm	108 mm	108 mm	108 mm	118 mm	121 mm
Max. vessel height for use with cap/lid ¹⁾	43 mm	108 mm	107 mm	108 mm	108 mm	118 mm	121 mm
Adapter							
Number of vessels per adapter/rotor	20/80	20/80	25/100	18/72	16/64	16/64	12/48
Bottom shape	flat	flat	flat with rubber mat	flat with rubber mat	flat with rubber mat	flat with rubber mat	conical
Centrifugation radius	165 mm	168 mm	168 mm	168 mm	168 mm	168 mm	173 mm
Max. RCF	2,950 × g	3,000 × g	3,000 × g	3,000 × g	3,000 × g	3,000 × g	3,100 × g
Packing	2 pcs.	2 pcs.	2 pcs.	2 pcs.	2 pcs.	2 pcs.	2 pcs.
Order no.	5810745004	5810746000	5810720001	5810747007	5810748003	5810721008	5810722004

¹⁾ Please perform a manual test to determine the actual loading capacity.²⁾ Please order adapter for 50 mL conical tubes skirted 5804737008 or 022654373 for U.S. and Canada.³⁾ Please note that these conical bottles need to be used together with a conical form insert provided by the manufacturer.



Guide

**Ordering information**

Description	Order no.
Rotor S-4x500 , for 500 mL rectangular buckets or MTP/Flex buckets	
incl. 4 x 500 mL rectangular buckets	5895170005
without buckets	5895171001
Rectangular bucket 500 mL , for Rotor A-4-81, 4 pcs.	5810730007
Cap , aerosol-tight, for 500 mL rectangular bucket, 2 pcs.	5810724007
Wide-neck bottle 500 mL , for Rotors A-4-81, S-4x500, rectangular, 2 pcs.	5820707003
Wide-neck bottle 400 mL , for Rotors A-4-81, S-4x500, 400 mL, lid blue, 2 pcs.	5810729009
MTP/Flex buckets , for Rotors A-4-81, S-4x500, for use with IsoRack and cell culture flask adapters as well as MTP and DWP, 2 pcs.	5810742005
MTP/Flex buckets , for Rotors A-4-81, S-4x500, for use with IsoRack and cell culture flask adapters as well as MTP and DWP, 4 pcs.	5810741009

25 mL snap cap	25 mL screw cap	50 mL screw cap	45 mL snap cap	30 – 50 mL round-bottom/ 50 mL conical, skirted ²⁾	180 – 250 mL flat/ 175 – 225 mL conical ³⁾	400 mL	500 mL	MTP, DWP, PCR plates
30 mm	30 mm	30 mm	30 mm	30 mm	62 mm	133 mm	83 mm	–
83 mm	78.5 mm	122 mm	122 mm	121 mm	133 mm	–	134 mm	60 mm
83 mm	78.5 mm	116 mm	116 mm	–	–	–	134	–
5/20	5/20	5/20	5/20	5/20	1/4	1/4	–/4	4/16 (MTP) 1/4 (DWP)
	conical			flat with rubber mat	flat with rubber mat	flat, rubber	flat	flat with rubber mat
158 mm	148 mm	173 mm	173 mm	173 mm	173 mm	180 mm	180 mm	163 mm
2,826 × g	2,647 × g	3,100 × g	3,100 × g	3,100 × g	3,100 × g	3,220 × g	3,220 × g	2 900 × g
	2 pcs.			2 pcs.	2 pcs.	2 pcs.	–	2 pcs.
	5810723000			5810739004	5825722000	5810728002	–	5810742005

Your local distributor: www.eppendorf.link/contactEppendorf UK Limited · Gateway 1000 · Whittle Way · Stevenage SG1 2FP · United Kingdom · sales@eppendorf.co.uk · www.eppendorf.com · www.eppendorf.link/eshop



Rotors for Centrifuge 5910 Ri



Rotor S-4x400

- > High-speed medium capacity swing-bucket rotor with max. speed $5,263 \times g$ (5,100 rpm)
- > Broad range of adapters enables high versatility for tubes and bottles from 0.2 mL to 400 mL
- > Aerosol-tight QuickLock caps for safe centrifugation of hazardous samples optionally available¹⁾

¹⁾ Aerosol-tightness tested by Public Health England, Porton Down, UK.

Adapters for Rotor S-4x400						
Tube Volume	1.5 mL/2.0 mL	12 mm x 75 mm	4 mL – 8 mL	7.5 mL – 12 mL	9 mL	Eppendorf Tubes® 5.0 mL and 15 mL conical
Max. tube diameter	11 mm	12 mm	13 mm	16 mm	17.5 mm	17 mm
Max. vessel height	39 mm	118 mm	119 mm	122 mm	122 mm	133 mm
Max. vessel height for use with cap/lid¹⁾	–	112 mm	105 mm	115 mm	115 mm	126 mm
Adapter						
Number of vessels per adapter/rotor	26/104	17/68	15/60	11/44	8/32	7/28
Bottom shape	open	round	round	round	round	conical
Centrifugation radius	177 mm	172 mm	171 mm	173 mm	173 mm	180 mm
Max. RCF	$5,147 \times g$	$5,002 \times g$	$4,818 \times g$	$4,874 \times g$	$4,874 \times g$	$5,071 \times g$
Packing	2 pcs.	2 pcs.	2 pcs.	2 pcs.	2 pcs.	2 pcs.
Order no.	5910708009	5910711000	5910703007	5910704003	5910709005	5910702000

¹⁾ Please perform a manual test to determine the actual loading capacity.²⁾ Please order adapter for 25 mL conical tubes snap cap 5820733004.³⁾ Please order adapter for 25 mL conical tubes screw cap 5820734000.

⁴⁾ Please note that these conical bottles need to be used together with a conical form insert provided by the manufacturer.



Ordering information

Description	Order no.
Rotor S-4x400 , incl. 400 mL round bucket	5895180000
Caps , for Rotor S-4x400, aerosol-tight, 2 pcs.	5910700008
Wide-neck bottle 400 mL , for Rotor S-4x400, 2 pcs.	5910707002

25 mL snap cap ²⁾	25 mL screw cap ³⁾	50 mL screw cap	45 mL snap cap	50 mL skirted, Centriprep and Oak Ridge 30 mL	175 mL conical (Becton Dickinson®, Nalgene® ⁴⁾), 250 mL flat	175 – 225 mL conical	400 mL
30 mm	30 mm	30 mm	30 mm	30 mm	62 mm	62 mm	81 mm
83 mm	78.5 mm	125 mm	125 mm	122 mm	138 mm	143 mm	117 mm
83 mm	78.5 mm	117 mm	117 mm	121 mm	129 mm	137 mm	117 mm
4/16	4/16	4/16	4/16	3/12	1/4	1/4	1/4
		conical		skirted	flat	conical	flat
152 mm	142 mm	179 mm	179 mm	170 mm	174 mm	181 mm	173 mm
4,420 × g	4,129 × g	5,043 × g	5,043 × g	4,943 × g	5,060 × g	5,263 × g	5,030 × g
		2 pcs.		2 pcs.	2 pcs.	2 pcs.	2 pcs.
		5910701004		5910712006	5910705000	5910714009	5910706006





Rotors for Centrifuge 5910 Ri/5920 R



Rotor S-4x750 with round buckets

- > Medium capacity swing-bucket rotor with max. speed 4,800 × g (4,700 rpm)¹⁾
- > Broad range of adapters enables high versatility for tubes and flasks from 0.2 mL to 750 mL and plates
- > Mixed loading with 2 plate buckets and 2 round tube buckets allows for increased versatility

¹⁾ For 100 V device, max. speed 4,031 × g /4,300 rpm

Adapters for Rotor S-4x750							
Tube Volume	1.5/2.0 mL	12 × 75 mm, 5 mL FACS	2.6 – 8 mL	5.5 – 12 mL	9 mL	14 mL	Eppendorf Tubes® 5.0 mL and 15 mL conical
Max. tube diameter	11 mm	12 mm	13 mm	16 mm	17.5 mm	17.5 mm	17 mm
Max. vessel height	39 mm	120 mm	121 mm	125 mm	117 mm	106 mm	125 mm
Max. vessel height for use with cap/lid¹⁾	39 mm	113 mm	113 mm	120 mm	112 mm	106 mm	120 mm
Adapter							
Number of vessels per adapter/rotor	50/200	27/108	23/92	20/80	20/80	14/56	14/56
Bottom shape	flat	round	round	round	round	round	conical
Centrifugation radius	194 mm	186 mm	185 mm	186 mm	185 mm	185 mm	188 mm
Max. RCF	4,791 × g	4,594 × g	4,569 × g	4,594 × g	4,569 × g	4,569 × g	4,643 × g
Packing	2 pcs.	2 pcs.	2 pcs.	2 pcs.	2 pcs.	2 pcs.	2 pcs.
Order no.	5825740009	5825747003	5825738004	5825736001	5825743008	5825748000	5825734009











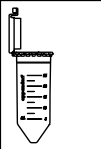

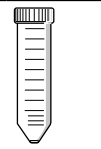
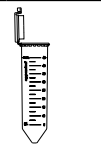
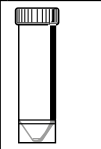
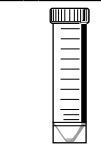
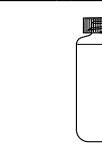
¹⁾ Exceeding the maximum tube length may reduce the loading capacity of the rotor. Please perform a manual swing-out test before starting the centrifuge run to make sure the tubes do not hit the rotor yoke.

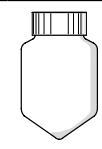
²⁾ Please order adapter for 25 mL conical tubes snap cap 5820733004. ³⁾ Please order adapter for 25 mL conical tubes screw cap 5820734000. ⁴⁾ Please note that these conical bottles need to be used together with a conical form insert provided by the manufacturer. ⁵⁾ 225 mL conical bottles from BD[®]/Corning[®] and 250 mL conical bottles from Nunc[®] for Rotor S-4-104 and S-4x750.

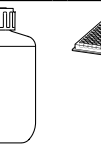

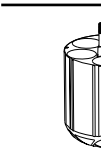
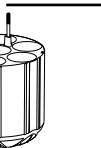
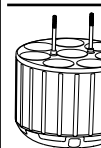
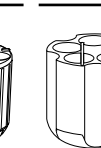
Ordering information

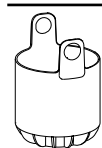
Description	Order no.
Rotor S-4x750 , aerosol-tight, without buckets	5895121004
Rotor S-4x750 , aerosol-tight, incl. round buckets	5895120008
Plate bucket , for Rotor S-4x750, aerosol-tight capable, incl. plate carrier, 2 pcs.	5895125000
Round bucket , for Rotor S-4x750, 2 pcs.	5895123007
Round bucket , for Rotor S-4x750, 4 pcs.	5895122000
Plate bucket , for Rotor S-4x750, aerosol-tight capable, incl. plate carrier, 4 pcs.	5895124003
Caps , rotors S-4-104, S-4x750, plate bucket, aerosol-tight, 2 pcs.	5820748001
Caps for 750 mL/1000 mL , for rotors S-4-104, S-4x750, S-4x1000, aerosol-tight, 2 pcs.	5820747005
Wide-neck bottle 750 mL , for Rotors S-4-104, S-4x750, S-4x1000, 2 pcs.	5820708000

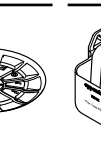
										
25 mL snap cap ²⁾	25 mL screw cap ³⁾	50 mL screw cap	45 mL snap cap	30 mL	50 mL conical, skirted	250 mL flat, 175 – 225/ 250 mL conical ⁴⁾⁵⁾	500 mL Corning®	750 mL	MTP, DWP, PCR plates	
30 mm	30 mm	30 mm	30 mm	25 mm	30 mm	62 mm	96 mm	102 mm	–	
83 mm	78.5 mm	122 mm	122 mm	119 mm	122 mm	145 mm	147 mm	150 mm	64 mm	
83 mm	78.5 mm	116 mm	116 mm	114 mm	116 mm	125 mm	–	150 mm	47 mm	
										
6/24	7/28	7/28	6/24	8/32	5/20	1/4	1/4	1/4	4/16 (MTP) 1/4 (DWP)	
	conical			flat	conical, skirted	flat	conical	flat	–	
167 mm	157 mm	187 mm	187 mm	181 mm	177 mm	183 mm	186 mm	185 mm	161 mm	
4,124 x g	3,877 x g	4,618 x g	4,618 x g	4,470 x g	4,371 x g	4,519 x g	4,594 x g	4,569 x g	3,976 x g	
	2 pcs.			2 pcs.	2 pcs.	2 pcs.	2 pcs.	2 pcs.	2 pcs.	
	5825733002			5825755006	5825732006	5825741005	5825745000	5825744004	5895125000	





Rotors for Centrifuge 5920 R



Rotor S-4xUniversal-Large

- > Extra high capacity swing-bucket rotor with max. speed 4,402 × g (4,250 rpm)
- > Broad range of adapters enables high versatility for tubes and flasks from 0.2 mL to 750 mL and plates
- > Universal bucket design accommodates both plates and tubes

Adapters for Rotor S-4xUniversal-Large										
Tube Volume	Eppendorf Tubes® 5.0 mL	15 mL conical	MTP, DWP	1.5/2.0 mL	5 mL FACS	25 mL snap cap ¹⁾	25 mL screw cap ²⁾	50 mL screw cap	45 mL snap cap	Microplate 96/384 wells
Max. tube diameter	17 mm	17 mm	-	11 mm	12 mm	30 mm	30 mm	30 mm	30 mm	-
Max. vessel height	131 mm	131 mm	45 mm	39 mm	113 mm	131 mm	131 mm	131 mm	131 mm	45 mm
Max. vessel height for use with cap/lid	123 mm	123 mm	45 mm	39 mm	82 mm	125 mm	125 mm	125 mm	125 mm	45 mm
Adapter										
Number of vessels per adapter/rotor	24/96	24/96	2 MTP, 1 DWP	92/368	51/204	10/40	10/40	10/40	10/40	2 MTP, 1 DWP
Bottom shape	conical	conical	skirted	flat	round	conical	conical	conical	conical	skirted
Centrifugation radius	218 mm	218 mm	160 mm	205 mm	205 mm	189 mm	179 mm	213 mm	213 mm	153 mm
Max. RCF	4,402 × g	4,402 × g	3,231 × g	4,140 × g	4,140 × g	3,816 × g	3,614 × g	4,301 × g		3,090 × g
Packing	2 pcs.	2 pcs.	2 pcs.	2 pcs.	2 pcs.	2 pcs.				
Order no.	5920757008			5920747002	5920742000	5920756001				

¹⁾ Please order adapter for 25 mL conical tubes snap cap 5820733004. ²⁾ Please order adapter for 25 mL conical tubes screw cap 5820734000. ³⁾ Please note that these conical bottles need to be used together with a conical form insert provided by the manufacturer.







25 mL snap cap ¹⁾	25 mL screw cap ²⁾	50 mL screw cap	45 mL snap cap	Microplate 96/384 Wells	250 mL flat, 175-225 mL conical ³⁾	2.6 – 8 mL	5.5 – 12 mL	9 mL	14 mL
30 mm	30 mm	30 mm	30 mm	-	62 mm	13 mm	16 mm	17.5 mm	17.5 mm
131 mm	131 mm	131 mm	131 mm	18 mm	133 mm	110 mm	110 mm	136 mm	123 mm
125 mm	125 mm	125 mm	125 mm	-	126 mm	107 mm	106 mm	130 mm	120 mm
10/40	10/40	10/40	10/40	1 MTP	1/4	49/196	37/148	28/112	24/96
conical	conical	conical	conical	skirted	flat	round	round	round	round
107 mm	155 mm	213 mm	213 mm	134 mm	207 mm	205 mm	204 mm	209 mm	210 mm
3,735 × g	3,509 × g	4,301 × g		2,706 × g	4,180 × g	4,140 × g	4,120 × g	4,221 × g	4,240 × g
		2 pcs.				2 pcs.	2 pcs.	2 pcs.	2 pcs.
		5920755005				5920739000	5920738003	5920746006	5920751000





Rotors for Centrifuge 5920 R



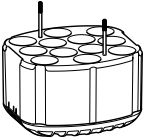
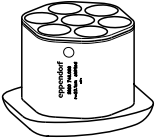
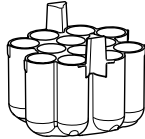
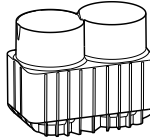
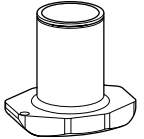



					
Adapters for Rotor S-4xUniversal-Large					
Tube Volume	30 mL	50 mL conical, skirted	50 mL Nalgene® Oak Ridge	250 mL flat, 175 – 225 mL conical ⁴⁾	250 mL conical (Corning®, Nunc®)
Max. tube diameter	25 mm	30 mm	29 mm	62 mm	62 mm
Max. vessel height	117 mm	141 mm	132 mm	133 mm	171 mm
Max. vessel height for use with cap/lid	108 mm	121 mm	121 mm	126 mm	144 mm
Adapter					
Number of vessels per adapter/rotor	12/48	7/28	12/48	2/8	1/4
Bottom shape	flat	conical, skirted	round	flat	conical
Centrifugation radius	194 mm	197 mm	206 mm	203 mm	208 mm
Max. RCF	3,918 × g	3,978 × g	4,160 × g	4,099 × g	4,200 × g
Packing	2 pcs.	2 pcs.	2 pcs.	2 pcs.	2 pcs.
Order no.	5920743007	5920748009	5920753002	5920740008	5920750003

⁴⁾ Please note that these conical bottles need to be used together with a conical form insert provided by the manufacturer.

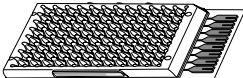
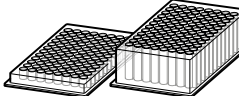
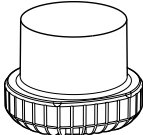
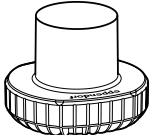
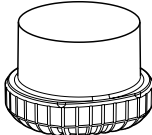

Ordering information

Description	Order no.
Rotor S-4xUniversal-Large , incl. universal buckets	589519006
Buckets , for Rotor S-4xUniversal-Large, 4 pcs.	589519209
Caps , Rotor S-4xUniversal-Large, universal buckets, aerosol-tight, 2 pcs.	592075206

				
500 mL conical Corning®	500 mL flat Nalgene®	750 mL	Micro Fluidic Cards	MTP, DWP, PCR plates
96 mm	69.5 mm	102 mm	–	–
160 mm	168 mm	166 mm	153 mm	116 mm
148 mm	143 mm	143 mm	–	110 mm
				
1/4	1/4	1/4	3/12	5/20 (MTP) 2/8 (DWP)
conical	flat	flat	flat	flat
208 mm	206 mm	202 mm	200 mm	196 mm
4,200 × g	4,160 × g	4,079 × g	4,039 × g	3,938 × g
2 pcs.	2 pcs.	2 pcs.	2 pcs.	2 pcs.
5920744003	5920745000	5920741004	5920749005	5920737007







Rotors for Centrifuge 5920 R

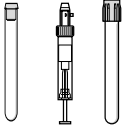
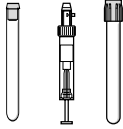

Rotor S-4x1000 high-capacity buckets

- > Extra high capacity swing-bucket rotor with max. speed 3,153 × g (3,700 rpm)
- > Bucket accommodates both plates and tubes
- > Buckets and adapters are autoclavable

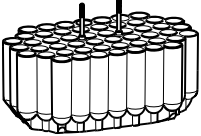
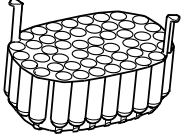
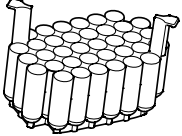
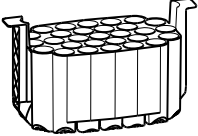
				
Adapters for Rotor S-4x1000 high-capacity buckets				
Tube Volume	5 mL FACS	2.6 – 8 mL	5.5 – 12 mL	9 mL
Max. tube diameter	12 mm	13 mm	16 mm	17.5 mm
Max. vessel height	108 mm	107 mm	107 mm	129 mm
Adapter				
Number of vessels per adapter/rotor	52/208	49/196	36/144	29/116
Bottom shape	round	round	round	round
Centrifugation radius	204 mm	204 mm	199 mm	204 mm
Max. RCF	3,122 × g	3,122 × g	3,046 × g	3,122 × g
Packing	2 pcs.	2 pcs.	2 pcs.	2 pcs.
Order no.	5920724002	5920718002	5920720007	5920722000

¹⁾ Please order adapter for 25 mL conical tubes snap cap 5820733004.²⁾ Please order adapter for 25 mL conical tubes screw cap 5820734000.³⁾ Please note that these conical bottles need to be used together with a conical form insert provided by the manufacturer.



Ordering information

Description	Order no.
Rotor S-4x1000 , incl. high-capacity buckets	5895118003
High-Capacity bucket , Rotor S-4x1000, 2 pcs.	5895107001
High-Capacity bucket , for Rotor S-4x1000, 4 pcs.	5895106005

Eppendorf Tubes® 5.0 mL and 15 mL conical	25 mL snap cap ¹⁾	25 mL screw cap ²⁾	50 mL screw cap	250 mL flat, 175 – 225 mL conical ³⁾ and Nunc® 250 mL conical	MTP, DWP, PCR plates
17 mm	30 mm	30 mm	30 mm	62 mm	–
121 mm	83 mm	78.5 mm	116 mm	148 mm	88 mm
27/108	12/48	13/52	13/52	2/8	6/24 (MTP) 2/8 (DWP)
conical		conical		flat	flat
205 mm	179 mm	169 mm	206 mm	200 mm	185 mm
3,138 × g	2,739 × g	2,586 × g	3,153 × g	3,061 × g	2,832 × g
2 pcs.		2 pcs.		2 pcs.	2 pcs.
5920716000		5920715003		5920717006	5920729004





Rotors for Centrifuge 5920 R



Rotor S-4x1000 plate/tube buckets

- > High capacity swing-bucket rotor with max. speed $3,076 \times g$ (3,700 rpm)
- > Bucket accommodates both plates and tubes
- > Aerosol-tight QuickLock caps for safe centrifugation of hazardous samples optionally available¹⁾

¹⁾ Aerosol-tightness tested by Public Health England, Porton Down, UK.

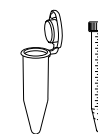
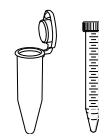
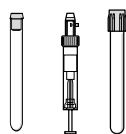
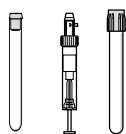

Adapters for Rotor S-4x1000 plate/tube buckets

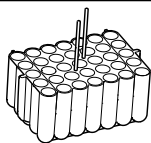
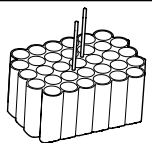
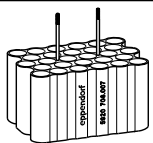
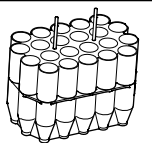
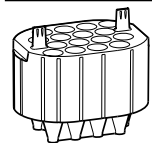
Tube Volume	2.6 – 8 mL	5.5 – 12 mL	9 mL	Eppendorf Tubes® 5.0 mL and 15 mL conical	Eppendorf Tubes® 5.0 mL and 15 mL conical
Max. tube diameter	13 mm	16 mm	17.5 mm	17 mm	17 mm
Max. vessel height	109 mm	109 mm	109 mm	121 mm	123 mm
Max. vessel height for use with cap/lid ¹⁾	108 mm	108 mm	109 mm	–	121 mm
Adapter					
Number of vessels per adapter/rotor	35/140	33/132	28/112	22/88	16/64
Bottom shape	round	round	round	conical	conical
Centrifugation radius	201 mm	200 mm	200 mm	201 mm	201 mm
Max. RCF	$3,076 \times g$	$3,061 \times g$	$3,061 \times g$	$3,076 \times g$	$3,076 \times g$
Packing	2 pcs.	2 pcs.	2 pcs.	2 pcs.	2 pcs.
Order no.	5920706004	5920707000	5920708007	5920710001	5920712004

¹⁾ Please perform a manual test to determine the actual loading capacity.²⁾ Please order adapter for 25 mL conical tubes screw cap 5820734000.³⁾ Please order adapter for 25 mL conical tubes snap cap 5820733004.



Ordering information

Description

Rotor S-4x1000, aerosol-tight, incl. plate/tube buckets

Order no.

[5895117007](#)

Caps, Rotor S-4x1000: plate/tube bucket; Rotor S-4x750: plate bucket, aerosol-tight, 2 pcs.

[5895111009](#)

Plate carrier, for Rotor S-4x1000 with plate/tube buckets, 2 pcs.

[5920705008](#)

Plate/tube bucket, for Rotor S-4x1000, 4 pcs.

[5895104002](#)

Plate/tube bucket, for Rotor S-4x1000, 2 pcs.

[5895105009](#)

25 ml screw cap ²⁾	25 ml snap cap ³⁾	50 mL screw cap	45 mL snap cap	25 mL screw cap ²⁾	25 mL snap cap ³⁾	45 mL snap cap	50 mL screw cap	MTP, DWP, PCR plates
30 mm	30 mm	30 mm	30 mm	30 mm	30 mm	30 mm	30 mm	-
78.5 mm	83 mm	121 mm		78.5 mm	83 mm	121 mm	121 mm	104 mm
-	-	-		78.5 mm	83 mm	121 mm	121 mm	91 mm
10/40	9/36	10/40	9/36	7/28	6/24	6/24	7/28	7/28(MTP) 2/8(DWP)
	conical				conical			flat
165 mm	175 mm	201 mm		166 mm	107 mm	201 mm	201 mm	198 mm
2,525 x g	2,678 x g	3,076 x g		2,540 x g	2,693 x g	3,076 x g	3,076 x g	3,030 x g
	2 pcs.				2 pcs.			2 pcs.
	5920709003				5920711008			5920705008









Rotors for Centrifuge 5920 R

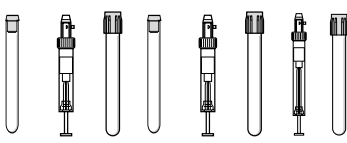
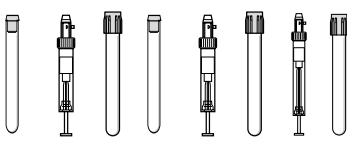
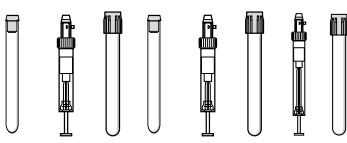
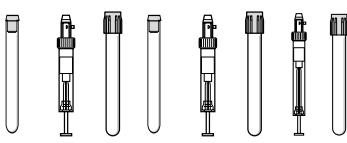

Rotor S-4x1000 round buckets

- > Medium capacity swing-bucket rotor with max. speed 3,428 × g (3,700 rpm)
- > Broad range of adapters enables high versatility for tubes and flasks from 0.2 mL to 1,000 mL
- > Mixed loading with 2 plate buckets and 2 round tube buckets allows for increased versatility

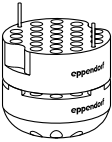
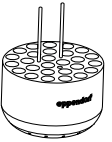
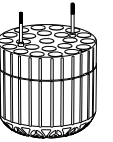
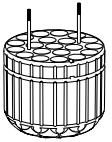
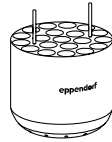
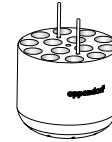
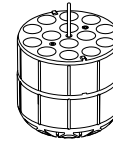
								
Adapters for Rotor S-4x1000 round buckets								
Tube Volume	1.5/2.0 mL	12 × 75 mm, 5 mL FACS	2.6 – 8 mL	5.5 – 12 mL	9 mL	14 mL	Eppendorf Tubes® 5.0 mL and 15 mL conical	25 mL snap cap ²⁾
Max. tube diameter	11 mm	12 mm	13 mm	16 mm	17.5 mm	17.5 mm	17 mm	30 mm
Max. vessel height	39 mm	115 mm	121 mm	140 mm	117 mm	117 mm	161 mm	83 mm
Max. vessel height for use with cap/lid¹⁾	39 mm	108 mm	113 mm	140 mm	112 mm	112 mm	150 mm	83 mm
Adapter								
Number of vessels per adapter/rotor	50/200	27/108	23/92	20/80	20/80	14/56	14/56	6/24
Bottom shape	flat	round	round	round	round	round	conical	conical
Centrifugation radius	219 mm	211 mm	210 mm	211 mm	210 mm	210 mm	224 mm	107 mm
Max. RCF	3,352 × g	3,229 × g	3,214 × g	3,229 × g	3,214 × g	3,214 × g	3,428 × g	2,005 × g
Packing	2 pcs.	2 pcs.	2 pcs.	2 pcs.	2 pcs.	2 pcs.	2 pcs.	2 pcs.
Order no.	5825740009	5825747003	5825738004	5825736001	5825743008	5825748000	5825734009	

¹⁾ Exceeding the maximum tube length may reduce the loading capacity of the rotor. Please perform a manual swing-out test before starting the centrifuge run to make sure the tubes do not hit the rotor yoke. ²⁾ Please order adapter for 25 mL conical tubes snap cap 5820733004. ³⁾ Please order adapter for 25 mL conical tubes screw cap 5820734000. ⁴⁾ Please note that these conical bottles need to be used together with a conical form insert provided by the manufacturer. ⁵⁾ 225 mL conical bottles from BD®/Corning® and 250 mL conical bottles from Nunc® for Rotor S-4-104 and S-4x750.



Ordering information

Description	Order no.
Round bucket, for Rotor S-4x1000, 2 pcs.	5895103006
Round bucket, for Rotor S-4x1000, 4 pcs.	5895102000
Rotor S-4x1000 round buckets, aerosol-tight, incl. 4 × 1,000 mL round buckets	5895100007
Caps for 750 mL/1000 mL, for rotors S-4-104, S-4x750, S-4x1000, aerosol-tight, 2 pcs.	5820747005
Wide-neck bottle 750 mL, for Rotors S-4-104, S-4x750, S-4x1000, 2 pcs.	5820708000

25 mL screw cap ³⁾	50 mL screw cap	45 mL snap cap	30 mL	50 mL conical, skirted	250 mL flat, 175 – 225/250 mL conical ⁴⁾⁵⁾	500 mL Corning®	500 mL Nalgene®	600 mL TPP	750 mL	1 Liter Nalgene®	MTP, DWP, PCR plates
30 mm	30 mm	30 mm	25 mm	30 mm	62 mm	96 mm	69.5 mm	98 mm	102 mm	98 mm	–
78.5 mm	156 mm	156 mm	144 mm	151 mm	176 mm	167 mm	183 mm	181 mm	150 mm	196 mm	104 mm
78.5 mm	150 mm	150 mm	139 mm	147 mm	156 mm	167 mm	183 mm	181 mm	150 mm	–	91 mm
7/28	7/28	6/24	8/32	5/20	1/4	1/4	1/4	1/4	1/4	1/4	7/28 (MTP) 2/8 (DWP)
conical	conical	conical	flat	conical, skirted	flat	conical	flat	conical	flat	flat	flat
121 mm	223 mm	223 mm	212 mm	209 mm	214 mm	218 mm	221 mm	224 mm	216 mm	218 mm	198 mm
1,852 × g	3,413 × g	3,413 × g	3,245 × g	3,199 × g	3,275 × g	3,336 × g	3,382 × g	3,428 × g	3,306 × g	3,336 × g	3,030 × g
2 pcs.	2 pcs.	2 pcs.	2 pcs.	2 pcs.	2 pcs.	2 pcs.	2 pcs.	2 pcs.	2 pcs.	2 pcs.	2 pcs.
5825733002			5825755006	5825732006	5825741005	5825745000	5920703005	5920701002	5825744004	5920700006	5895105009





Overview of Fixed-Angle Rotors Centrifuge 59xx Family



Model	Rotor FA-6x250	Rotor FA-6x50	Rotor FA-20x5
Description	Processing of cells in higher volumes at high speed	Molecular biology applications in tubes up to 50 mL	Applications in Eppendorf Tubes® 5.0 mL
5910 Ri	■	■	■
5920 R	■	■	■
Aerosol-tightness	yes	yes	yes
Max. capacity	6 × 250 mL	6 × 50 mL	20 × 5 mL
Max. RCF	15,054 × g	20,130 × g	20,913 × g
Max. speed	10,100 rpm	12,100 rpm	13,100 rpm
1.5/2.0 mL micro tube		6	20
Eppendorf Tubes® 5.0 mL and 15 mL conical	24	6	20/0
25 mL conical tubes	6 ¹⁾²⁾	6 ³⁾⁴⁾	
50 mL conical tubes	6	6	
85 mL Oakridge tubes	6		
250 mL conical tubes	6		

¹⁾ Screw cap tubes only. ²⁾ Please order adapter for 25 mL conical tubes screw cap 5820734000. ³⁾ Please order adapter for 25 mL conical tubes screw cap 5820734000. ⁴⁾ Please order adapter for 25 mL conical tubes snap cap 5820733004.

Advanced Rotor Design



Cross section of Rotor FA-6x50 (6 × 50 mL conical) showing the light-weight design. All metal not needed for safety or performance is hollowed out to reduce weight and improve handling.

Low rotor weight

Eppendorf's fixed-angle rotors are among the lightest in the industry to improve handling and operational safety. Light-weight rotors cause less wear and tear on the motor and allow for faster acceleration and braking times.

**Rotor FA-48x2**

Aerosol-tight microcentrifuge tube rotor

■
■
yes
48 x 2 mL
21,194 x g (5920 R) / 22,132 x g (5910 Ri)
13,700 rpm (5920 R) / 14,000 rpm (5910 Ri)
48

**Rotor FA-30x2**

Aerosol-tight microcentrifuge tube rotor for safe centrifugation of hazardous samples

■
-
yes
30 x 2 mL
20,984 x g
13,700 rpm
30

**Rotor F-48x15**

High-capacity fixed-angle rotor for 15 mL conical and glass tubes

■
-
40 x 15 mL
5,005 x g
5,500 rpm
0/40

Eppendorf QuickLock® lids for ergonomic lid locking

Our aerosol-tight QuickLock rotors close with only ¼ of a turn. This not only saves you time during every day use, it also takes repetitive stress off your wrist.

Superior temperature control

Aluminum, with its high heat conductivity, allows fast pre-cooling and accurate temperature control in refrigerated centrifuges.

**Perfect fit with Eppendorf Conical Tubes 15 mL and 50 mL**

The Eppendorf Conical Tubes are characterized by an outstanding centrifugation stability of up to 19,500 x g¹⁾. This makes them suited for a broad range of applications.

¹⁾ Test conditions: Rotor FA-45-6-30 in Eppendorf Centrifuge 5810 R (using a suitable centrifuge adapter for 15 mL tube), sample: Saline solution (density: 1.0 g/mL), controlled centrifugation temp.: 25 °C, centrifugation time: 90 min (SnapTec® tube: 17,000 x g max.)





Rotors for Centrifuge 5910 Ri/5920 R



Rotor FA-6x250

- > Fixed-angle rotor for up to 6 x 250 mL bottles¹⁾
- > Ideal for the pelleting of microorganisms and mammalian cells
- > 12 different adapters for broad range of additional applications

¹⁾ To run this rotor, a software update is required for earlier centrifuges (5910 R & 5920 R). Please contact your local Eppendorf organization or dealer for further information.





Ordering information

Description

Rotor FA-6x250, aerosol-tight, for 6 x 250 mL bottles, incl. Eppendorf QuickLock® rotor lid

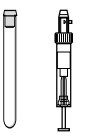
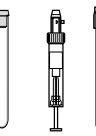
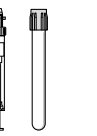
Order no.

[5895175007](#)

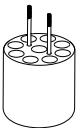
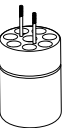
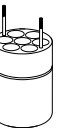
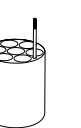
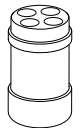
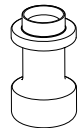
								
Adapters for Rotor FA-6x250								
Tube Volume	5 mL	2.6 – 8.0 mL	5.5 – 12.0 mL	9 mL	Eppendorf Tubes® 5.0 mL and 15 mL	25 mL screw cap ²⁾	50 mL screw cap	45 mL snap cap
Max. tube diameter	12 mm	13 mm	16 mm	17.5 mm	17 mm	30 mm	30 mm	30 mm
Max. vessel height for use with cap/lid¹⁾	114 mm	114 mm	115 mm	112 mm	122 mm	78.5 mm	125 mm	125 mm
Adapter								
Number of vessels per adapter/rotor	9/54	8/48	7/42	7/42	4/24	1/6	1/6	1/6
Bottom shape	round	round	round	round	conical	conical		
Centrifugation radius	126 mm	125 mm	125 mm	126 mm	120 mm	95 mm	110 mm	110 mm
Max. RCF	14,370 × g	14,256 × g	14,256 × g	14,370 × g	13,686 × g	10,834 × g	12,545 × g	12,545 × g
Packing	2 pcs.	2 pcs.	2 pcs.	2 pcs.	2 pcs.	2 pcs.		
Order no.	5920765000	5920763008	5920762001	5920764004	5920761005	5920760009		

¹⁾ Please perform a manual test to determine the actual loading capacity. ²⁾ Please order adapter for 25 mL conical tubes screw cap 5820734000. ³⁾ 175 mL conical bottles from BD/Corning® (352076). Please note that these conical bottles need to be used together with a conical form insert provided by the bottle manufacturer. ⁴⁾ 250 mL flat bottom bottles from Nalgene® (3127-0250, 3122-0250, 3120-0250) and Corning® (431841, 431842). When used with wide lid 250 mL flat bottom bottle from Nalgene® (3140-0250) max. capacity is reduced to 4 x 250 mL.



50 mL	10 mL	16 mL	30 mL	50 mL	85 mL	175 mL ³⁾	250 mL ⁴⁾
30 mm	17 mm	18 mm	26 mm	29 mm	38 mm	62 mm	62 mm
125 mm	115 mm	115 mm	116 mm	125 mm	118 mm	118 mm	135 mm
1/6	7/42	7/42	3/18	1/6	1/6	1/6	1/6
conical, skirted	round	round	round	round	round	conical	flat
108 mm	126 mm	126 mm	125 mm	111 mm	113 mm	132 mm	132 mm
12,317 × g	14,370 × g	14,370 × g	14,256 × g	12,659 × g	12,887 × g	15,054 × g	15,054 × g
2 pcs.	2 pcs.	2 pcs.	2 pcs.	2 pcs.	2 pcs.	-	-
5920766007	5920769006	5920770004	5920767003	5920771000	5920768000	Conical form insert required ³⁾	No adapter required ⁴⁾





Rotors for Centrifuge 5910 Ri/5920 R



Rotor FA-6x50

- > High-speed rotor for applications in tubes from 5 – 50 mL
- > Max. speed 20,130 × g (12,100 rpm)
- > Eppendorf QuickLock® rotor lid for fast lid locking

Ordering information

Description

Rotor FA-6x50, aerosol-tight, incl. rotor lid, 6 × 50 mL conical tubes

Order no.

[5895150004](#)

Adapters for Rotor FA-6x50						
Tube Volume	2.6 – 5 mL	4 – 8 mL	5.5 – 10 mL	7.5 – 12 mL	Eppendorf Tubes® 5.0 mL	7 – 17 mL
Max. tube diameter	13 mm	13 mm	16 mm	16 mm	17 mm	17.5 mm
Max. vessel height for use with cap/lid	119 mm	119 mm	119 mm	119 mm	121 mm	112 mm
Adapter						
Number of vessels per adapter/rotor	1/6	1/6	1/6	1/6	1/6 ¹⁾	1/6
Bottom shape	round	round	round	round	conical	round
Centrifugation radius	120 mm	120 mm	120 mm	120 mm	121 mm	120 mm
Max. RCF	19,642 × g	19,642 × g	19,642 × g	19,642 × g	19,806 × g	19,642 × g
Packing	2 pcs.	2 pcs.	2 pcs.	2 pcs.	2 pcs.	2 pcs.
Order no.	5820726008	5820725001	5820728000	5820727004	5820730005	5820729007

¹⁾ Eppendorf Tubes® 5.0 mL with screw cap will not fit in this adapter.



Eppendorf Tubes® BioBased

- > Tubes are made from 90 % renewable-based feedstock plus 10 % fossil-based feedstock
- > ACT labeled – Environmental Impact Factor Certification
- > “Certified ISCC PLUS Manufacturer” (International Sustainability & Carbon Certification)
- > General Quality Certificates / Compliance with Standards, lot-specific certificates available
- > Eppendorf Tubes® in 5.0 mL, 15 mL, 25 mL and 50 mL in Sterile (sterile, pyrogen-free, DNase- / RNase-free, DNA (human and bacterial) free)

[For more information go to chapter “tubes and plates”.](#)



15 mL	16 mL	30 mL	25 mL snap cap	25 mL screw cap	35 mL	50 mL screw cap	45 mL snap cap
17 mm	18 mm	26 mm	30 mm	30 mm	29 mm	30 mm	30 mm
121 mm	107 mm	104 mm	83 mm	78.5 mm	113 mm	116 mm	118 mm
1/6	1/6	1/6	1/6	1/6	1/6	-/6	-/6
conical	round	round	conical	conical	conical	conical	conical
120 mm	120 mm	105 mm	104 mm	97 mm	112 mm	123 mm	123 mm
19,642 × g	19,642 × g	17,187 × g	17,023 × g	15,877 × g	18,333 × g	20,133 × g	20,133 × g
2 pcs.	2 pcs.	2 pcs.	6 pcs.	6 pcs.	2 pcs.	-	-
5820717009	5820720000	5820721006	5820733004	5820734000	5820722002	-	-





Rotors for Centrifuge 5910 Ri/5920 R



Rotor FA-20x5

- > 20 places for Eppendorf Tubes® 5.0 mL¹⁾
- > Max. speed: 20,913 × g (13,100 rpm)
- > Aerosol-tight²⁾ Eppendorf QuickLock® rotor lid

¹⁾ For Eppendorf Tubes® 5.0 mL with screw cap the capacity is limited to 10 tubes.

²⁾ Aerosol-tightness tested by Public Health England, Porton Down, UK.

Ordering information

Description	Order no.
Rotor FA-20x5 , aerosol-tight, for 20 Eppendorf Tubes® 5.0 mL, incl. Eppendorf QuickLock® rotor lid	5895130003
Adapter , for 1 vessel 1.5 – 2.0 mL, for all 5.0 mL rotors, 4 pcs.	5820768002
Adapter , for 1 cryo tube, for all 5.0 mL rotors, 4 pcs.	5820769009
Adapter , for 1 HPLC tube, for all 5.0 mL rotors, 4 pcs.	5820770007



Rotor FA-48x2

- > 48 places for 1.5/2.0 mL tubes
- > Max. speed: 21,194 × g/13,700 rpm (5920 R) / 22,132 × g / 14,000 rpm (5910 Ri)
- > Eppendorf QuickLock® rotor lid for fast lid locking

Ordering information

Description	Order no.
Adapter , for 1 PCR tube (0.2 mL, max. Ø 6 mm), for all 1.5/2.0 mL rotors, 6 pcs.	5425715005
Adapter , for 1 sample tube (0.5 mL, max. Ø 8 mm) or 1 Microtainer® (0.6 mL, max. Ø 8 mm), for all 1.5/2.0 mL rotors, 6 pcs.	5425716001
Rotor FA-48x2 , 48 × 1.5/2 mL tubes, incl. aerosol-tight Eppendorf QuickLock® rotor lid	5895135005
Adapter , for 1 micro test tube (0.4 mL, max. Ø 6 mm), for all 1.5/2.0 mL rotors, 6 pcs.	5425717008



Rotor F-48x15

- > High-capacity fixed-angle rotor for 15 mL conical and glass tubes
- > Maximum speed: 5,005 × g (5,500 rpm)
- > Form inserts for 15 mL conical tubes

Ordering information

Description	Order no.
Rotor F-48x15 , for 40 × 15 mL conical tubes, incl. 48 steel sleeves and adapters	5895160000



Rotors for Centrifuge 5910 Ri



Rotor FA-30x2

- > 30 places for 1.5/2.0 mL tubes
- > Max. speed: 20,984 × g (max. 13,700 rpm)
- > Eppendorf QuickLock® rotor lid for fast lid locking

Ordering information

Description

Rotor FA-30x2, incl. aerosol-tight Eppendorf QuickLock® rotor lid

Order no.

[5895155006](#)

Mobile Tables



Description

Is space a limited resource in your lab or are you looking for an ergonomic location for your Eppendorf tabletop centrifuge? The new Eppendorf Mobile Tables save precious benchtop space and provide the freedom and flexibility to use your Centrifuge 5804/5804 R, 5810/5810 R, 5910 Ri or 5920 R wherever you need it.

Product features

- > Designed for Centrifuge 5804/5804 R, 5810/5810 R, 5910 R/5910 Ri, 5920 R
- > Save precious benchtop space
- > Sturdy design for safe centrifugation

Ordering information

Description

Mobile table for under bench storage (low design), fits under standard 90 cm lab bench with centrifuge lid closed

for Centrifuge 5804/5804 R, 5810/5810 R, 5910 R, 5910 Ri and 5920 R

Order no.

[5921000010](#)

Mobile table for ergonomic loading and unloading (high design), fits in any empty floor space

for Centrifuge 5804/5804 R, 5810/5810 R, 5910 R, 5910 Ri and 5920 R

[5921000012](#)





Concentrator plus



Description

With its advanced heating technology, the Eppendorf Concentrator plus facilitates fast and efficient, gentle vacuum concentration of DNA, RNA, nucleotides, proteins and other liquid or wet samples. Its new coated lid provides superior chemical resistance against many acids and organic solvents.

Product features

- > Comes in 3 system configurations
- > Extremely quiet operation <50 dB(A)
- > Chemical-resistant, maintenance-free PTFE diaphragm pump eliminates the need for changing pump oil

Technical specifications

Model	Concentrator plus basic	Concentrator plus system	Concentrator plus system w/port
Vacuum		20 hPa (20 mbar)	20 hPa (20 mbar)
Sample capacity	max. 144 vessels/2 microplates	max. 144 vessels/2 microplates	max. 144 vessels/2 microplates
Fixed speed	1,400 rpm	1,400 rpm	1,400 rpm
Tube volume	0.2 – 50 mL	0.2 – 50 mL	0.2 – 50 mL
Port to connect external devices to vacuum pump	no	no	yes
Power supply	230 V, 50 – 60 Hz	230 V, 50 – 60 Hz	230 V, 50 – 60 Hz
Max. power consumption	150 W	350 W	350 W
Dimensions (W x D x H)	33 x 37 x 23 cm / 12.6 x 14.5 x 9.1 in	33 x 58 x 29 cm / 12.6 x 20.9 x 11.7 in	33 x 58 x 29 cm / 12.6 x 20.9 x 11.7 in
Weight w/o accessories	16.5 kg / 37.5 lb	31.5 kg / 68.3 lb	31.5 kg / 68.3 lb

Ordering information

Description	Order no.
Concentrator plus basic device, w/o pump, with Rotor F-45-48-11 230 V/50 – 60 Hz (GB)	5305000169
Concentrator plus complete system, with integrated diaphragm vacuum pump with Rotor F-45-48-11, 230 V/50 – 60 Hz (GB)	5305000363
without rotor, 230 V/50 – 60 Hz (GB)	5305000568
Concentrator plus complete system, with integrated diaphragm vacuum pump, with connection, e.g., for a gel dryer without rotor, 230 V/50 – 60 Hz (GB)	5305000762
Adapter, for 1 PCR tube (0.2 mL, max. Ø 6 mm), for all 1.5/2.0 mL rotors, 6 pcs.	5425715005
Adapter, for 1 sample tube (0.5 mL, max. Ø 8 mm) or 1 Microtainer® (0.6 mL, max. Ø 8 mm), for all 1.5/2.0 mL rotors, 6 pcs.	5425716001
CombiSlide Adapter, for 12 slides Combi Slide, for Rotors A-2-MTP and A-4-81 (MTP), 2 pcs.	5825706005
Adapter, for 1 PCR tube 0.2 mL, for Rotor F-45-72-8, 6 pcs.	5425723008
Spacer for simultaneous operation of two rotors, for rotors F-45-72-8 and F-45-48-11	5301316005
Adapter, for 1 micro test tube (0.4 mL, max. Ø 6 mm), for all 1.5/2.0 mL rotors, 6 pcs.	5425717008

✎ Ordering information for other voltage options can be found in the “Voltage Version” chapter.



Rotors for Concentrator plus



Rotor F-45-48-11

- > Rotor for 48 × 1.5/2.0 mL microcentrifuge tubes
- > A spacer enables additional stacking (double capacity)



Rotor F-35-6-30

- > Rotor for 6 × 50 mL conical tubes
- > Rotor for 6 × 15 mL conical tubes
- > Also accommodates for 6 × 25 mL conical tubes



Rotor A-2-VC

- > For use with MTP, PCR and Deepwell Plates up to 27 mm high
- > A work tray with frame is available for PCR test plates and microplates without frames
- > Rotor can be autoclaved for 20 min. at 121°C



Rotor F-45-22-17

- > Max. load: 22 × 5.0 mL
- > Tube Options: Snap caps and screw caps
- > Tube diameter: 17 mm

Ordering information

	Description	Max. tube dimensions Ø x L	Sample capacity	Order no.
	Rotor F-45-72-8	8 × 31 mm ¹⁾	72 × 0.5 mL	5490034007
	Rotor F-45-70-11	11 × 41/47 mm	70 × 1.5 mL, 70 × 2.0 mL	5490032004
	Rotor F-45-48-11	11 × 41/47 mm ¹⁾	48 × 1.5 mL/2.0 mL	5490030001
	Rotor F-45-22-17	17 × 59.4-67.4 mm	22 × 5.0 mL	5490048008
	Rotor F-40-36-12	12 × 32 mm	36 × 1.5 mL	5490040007
	Rotor F-45-36-15	15 × 45 – 48 mm ²⁾	36 × 3.0/5.0 mL	5490035003
	Rotor F-45-16-20	20 × 42 – 55 mm ²⁾	16 × 6.5/10 mL	5490043006
	Rotor F-40-18-19	19 × 66 mm	18 × 10 mL	5490037006
	Rotor F-45-12-31	31 × 55 mm	12 × 20 mL	5490044002
	Rotor F-35-8-24	24 × 86 – 105 mm ²⁾	8 × 25 mL	5490039009
	Rotor F-45-24-12	12 × 67 – 100 mm ^{2) 3)}	24 × 5 – 7 mL	5490036000
	Rotor F-50-8-16	16 × 105 – 120 mm ²⁾	8 × 8 – 12 mL	5490041003
	Rotor F-50-8-18	18 × 105 – 128 mm ²⁾	8 × 10 – 18 mL	5490042000
	Rotor F-45-8-17	17 × 116 – 123 mm ²⁾	8 × 15 mL conical tubes	5490038002
	Rotor F-35-6-30	17 × 116 – 123 mm or 30 × 116 – 123 mm ²⁾	6 × 15 mL conical tubes or 6 × 50 mL conical tubes	5490047001
		Rotor A-2-VC	128 × 86 × 27 mm	2 × MTP or skirted PCR plates 2 × Deepwell plates (DWP) (max. height = 27 mm)

¹⁾ Rotor is stackable for double capacity using spacer 5301316.005. ²⁾ Min./max. tube length. ³⁾ Tube length = 75 mm: max capacity 24 tubes, tube length > 75 mm: max capacity 12 tubes.





High-Speed Centrifuge CR22N



Whether your work requires harvesting of biomass in volumes of up to 6 L per run, pelleting of cells, subcellular organelles or larger viruses, or extraction, precipitation, concentration and purification of nucleic acids in up to 50 mL tubes, the Centrifuge CR22N is the optimal solution to support your everyday centrifugation tasks.

- > Speeds of up to 58,700 x g (fixed-angle) or 11,500 x g (swing-bucket) support applications in genomics, cell biology and proteomics
- > Unique 1.5 L triangular bottle for easy and time efficient harvesting of cells, yeast and bacterial cultures (up to 15,100 x g)
- > Large touchscreen interface for fast and easy operation
- > User management and documentation function supports labs working in a GxP environment
- > Self-locking rotor system for increased safety and convenience

Ordering information

Description	Order no.
High-Speed Centrifuge CR22N, refrigerated, 230 V/50/60 Hz (no plug), 30 A	5721220012
CR22N Harvesting Bundle (4 x 1.5 L), refrigerated, High-Speed Centrifuge CR22N incl. rotor R9A2 and 4 x 1.5 L triangular bottles, 230 V/50/60 Hz (no plug), 30 A	5721261412

✎ Ordering information for other voltage options can be found in the “Voltage Version” chapter.

Inquire with our service experts to install your fitting plug



Unique 1.5 L Triangular Bottle – Spinning Made Easy



Gain great flexibility and save precious time with our innovative triangular bottles:

- > No minimum filling level. Spin samples between 0 – 1.5 L without worrying about bottle stability
- > Reduces handling steps during the separation process such as balancing, supernatant harvesting, pellet recovery and cleaning of bottles after the run

Ordering information

Description	Order no.
Rotor R9A2 , fixed-angle rotor, incl. 4 x 1500PP bottle (WM), for Centrifuge CR22N	5721221014
Rotor R9A2 , fixed-angle rotor, incl. 4 x 1500PP bottle (WM), for Centrifuge CR30NX	5721302115

Learn more about the benefits of our unique 1.5 L triangular bottle



www.eppendorf.link/triangular-bottle





Rotors for Centrifuge CR22N

Product Name	Max. capacity	Max. speed	Max. RCF
fixed-angle rotor			
Rotor R9A2	4 x 1,500 mL	8,500 rpm	15,100 × g
Rotor R9A	4 x 1,000 mL	9,000 rpm	15,300 × g
Rotor R10A3	6 x 500 mL	10,000 rpm	18,800 × g
Rotor R10A5	6 x 500 mL	10,000 rpm	18,900 × g
Rotor R12A3	6 x 250 mL	12,000 rpm	23,800 × g
Rotor R12A4	72 x 2 mL	12,000 rpm	23,800 × g
Rotor R12A6	4 x 500 mL	12,000 rpm	22,500 × g
Rotor R13A	6 x 250 mL	13,000 rpm	26,400 × g
Rotor R14A	4 x 250 mL	14,000 rpm	30,240 × g
Rotor R14A3	10 x 100 mL	14,000 rpm	29,100 × g
Rotor R15A	10 x 50 mL	15,000 rpm	32,300 × g
Rotor R18A	8 x 50 mL	18,000 rpm	42,200 × g
Rotor R19A	6 x 80 mL	19,000 rpm	45,600 × g
Rotor R20A2	8 x 50 mL	20,000 rpm	48,000 × g
Rotor R21A	16 x 11 mL	21,000 rpm	53,250 × g
Rotor R21A2	6 x 30 mL	21,000 rpm	50,000 × g
Rotor R22A	18 x 7 mL	22,000 rpm	54,700 × g
Rotor R22A4	30 x 2 mL	22,000 rpm	55,200 × g
Rotor R22A6	12 x 10 mL	22,000 rpm	55,100 × g
Rotor R27A	8 x 50 mL	22,000 rpm	58,700 × g
special seal type fixed-angle rotor			
Rotor R8AY	6 x 500 mL	8,000 rpm	12,000 × g
Rotor R12AY	4 x 250 mL	12,000 rpm	22,200 × g
Rotor R16AY	6 x 80 mL	16,000 rpm	32,300 × g
Rotor R18AY	8 x 50 mL	18,000 rpm	38,800 × g
swing-bucket rotor			
Rotor R3S	4 x 500 mL	3,000 rpm	1,940 × g
Rotor R4SS	40 x 15 mL	4,000 rpm	2,900 × g
Rotor R5S4	NA	4,700 rpm	3,100 × g
Rotor R6S		5,700 rpm	5,010 × g
Rotor R8S	4 x 50 mL	8,000 rpm	11,500 × g
Rotor R10S	4 x 50 mL	10,000 rpm	16,470 × g
Rotor R15S3	4 x 12 mL	15,000 rpm	28,700 × g
horizontal rotor			
Rotor R10H	NA	10,000 rpm	13,000 × g
soil dehydration rotor			
Rotor R11D2	4 x 110 mL	11,000 rpm	15,800 × g

The maximum capacity refers to the nominal volume. The maximum filling volume may depend on the application, rotor and speed. Please consult with your sales representative for further details.



Separation example	Included tube/ bottle	Order no.
For harvesting of bacteria, cells or yeast for e.g. recombinant protein or antibody purification in easy to handle bottles with 4 x 1.5 L.	4 x 1500PP bottle (WM)	5721221014
For harvesting of bacteria, cells or yeast for e.g. recombinant protein or antibody purification in bottles with 4 x 1 L.	4 x 1000PP bottle (WM)	5721221015
For harvesting of bacteria, cells or yeast for e.g. recombinant protein purification or cell compartment purification in 6 x 500 mL bottles.	6 x 500PP bottle	5721221013
For harvesting of bacteria, cells or yeast for e.g. recombinant protein purification or cell compartment purification in 6 x 500 mL Nalgene® bottles.		5721221012
For harvesting of bacteria, cells or yeast for e.g. recombinant protein or cell compartment purification in 6 x 250 mL bottles.	6 x 250PP bottle	5721221011
		5721221106
For harvesting of bacteria, cells or yeast for e.g. recombinant protein purification or cell compartment purification in 4 x 500 mL Nalgene® bottles.	4 x 500PP bottle	5721221010
Lighter Rotor for harvesting of bacteria, cells or yeast and removing cellular debris for e.g. recombinant protein or cell compartment purification in 6 x 250 mL bottles.	6 x 250PP bottle	5721221009
For harvesting of bacteria, cells or yeast and removing cellular debris for e.g. recombinant protein or cell compartment purification in 4 x 250 mL bottles.	4 x 250PP bottle	5721221008
	80PP bottle	5721221105
For removing cellular debris or differential pelleting of subcellular organelles/compartments in conical tubes with 10 x 50 mL.	100 x 50TC tube and 100 x 15TC tube	5721221007
For fast removal of cellular debris or differential pelleting of subcellular organelles/compartments in conical tubes with 8 x 50 mL.	100 x 50TC tube	5721221006
Ideal for differential pelleting of cells and subcellular organelles, as well as the extraction, precipitation, concentration and purification of nucleic acids	6 x 80PP bottle	5721221103
For differential pelleting of subcellular organelles/compartments in tubes with 8 x 50 mL.	8 x 50PP tube	5721302106
	16 x 11PP thick-walled tube	5721221102
For differential pelleting of subcellular organelles/compartments or larger virus particles in tubes with 6 x 30 mL.	6 x 30PP bottle	5721221004
	7PP tube	5721221101
		5721221003
For pelleting of subcellular organelles/compartments or larger virus particles. For high throughput of small volumes with 30 x 2 mL tubes.		
For pelleting of subcellular organelles/compartments or larger virus particles in tubes with 12 x 10 mL.	12 x 10PP bottle	5721221002
For pelleting of subcellular organelles/compartments or larger virus particles in tubes with 8 x 50 mL.	8 x 50PP bottle	5721202101
	6 x 500PP bottle	5721221113
	4 x 250PP bottle	5721221112
	6 x 80PP bottle	5721221111
	8 x 50PP bottle	5721221110
For serum isolation or harvesting of bacteria or cells. For mid volumes with up to 4 x 500 mL tubes.		5721224003
For serum isolation, protein concentration in columns or harvesting of bacteria or cells in round bottom tubes with 40 x 15 mL.		5721264002
For plate centrifugation for e.g. ELISA or PCR in up to 12 x 96 plates.		5721224001
		5721224104
For strong pelleting of bacteria, yeast or cells for e.g. recombinant protein purification in conical tubes with 4 x 50 mL.		5721202400
	4 x 50PP tube	5721224102
	4 x 11PP thick-walled tube	5721224101
For plate centrifugation for e.g. PCR or cell-free protein synthesis with up to 12 x 96 plates.		5721227000
For liquid separation from soil or other solid organic material.		5721228000





High-Speed Centrifuge CR30NX

With high speeds up to 110,000 x g, this centrifuge reaches g-forces that cross into the range of ultracentrifugation, making it the optimal solution for laboratories continuous flow and high-speed rotors. From harvesting of biomass via continuous flow to separation steps of small particles such as viruses, organelles, extracellular vesicles or nanoparticles, the outstanding versatility and performance of Centrifuge CR30NX covers them all.

- > 2-in-1 model: suitable for centrifugation steps with super-speed requirements (with vacuum function)
- > Unique 1.5 L triangular bottle for easy and time efficient harvesting of cell, yeast and bacterial cultures (up to 15,100 x g)
- > Immediate rotor recognition and self-locking rotor system for highest level of user safety
- > Large touchscreen interface for fast and easy operation
- > User management and documentation functions support labs working in a GxP environment
- > Rotors for biomass harvesting via continuous flow and super-speed pelleting available.



Ordering information

Description

High-Speed Centrifuge CR30NX, refrigerated, 230 V/50/60 Hz (no plug), 30 A, 1-phase

CR30NX Harvesting Bundle (4 x 1.5 L), refrigerated, High-Speed Centrifuge CR30NX incl. rotor R9A2 and 4 x 1.5 L triangular bottles, 230 V/50/60 Hz (no plug), 30 A, 1-phase

Order no.

[5721300012](#)

[5721351512](#)

✎ Ordering information for other voltage options can be found in the "Voltage Version" chapter.

Inquire with our service experts to install your fitting plug

Learn more about
our high-speed
centrifuges



[www.eppendorf.link/
high-speed](http://www.eppendorf.link/high-speed)



Super-Speed Rotors – No Switching Needed



Choose from two rotors with max. speed of 110,000 x g:

- > Top-loading swing-bucket rotor for high-speed density gradient applications (e.g. rate zonal or Isopycnic centrifugation)
- > Fixed-angle rotor for cell fractionation (e.g. Virus-, viral particle or exosome pelleting)
- > With the self-locking rotor system and the immediate rotor recognition, you can toggle between applications in just a few minutes

Continuous flow rotor - For Biomass Harvesting



Choose from two continuous flow Rotors R10C2 or R18C2:

- > For continuous flow harvesting of bacteria, cells or yeast for e.g. recombinant protein or antibody purification in very large volumes of >10 L
- > Maximum speeds of up to 14,290 x g for Rotor R10C2 and 35,100 x g for Rotor R18C2, respectively

Ordering information

Description	Order no.
Rotor R30AT , fixed-angle rotor, Super-Speed Pelleting Kit 8 x 50 mL, incl. 8 x 50PP bottle, for Centrifuge CR30NX	5721302101
Rotor R25ST , swing-bucket rotor, Super-Speed Pelleting Kit 6 x 40 mL, incl. 50 x 40PP tube, for Centrifuge CR30NX	5721302400
Rotor R10C2 , continuous flow rotor, Continuous Flow Kit, rotor nominal capacity: 3,200 mL, incl. seal unit, for Centrifuge CR30NX	5721352601
Rotor R18C2 , continuous flow rotor, rotor nominal capacity: 1,000 mL, batch unit excl. seal unit, for Centrifuge CR30NX	5721302600





Rotors for Centrifuge CR30NX

Product Name	Max. capacity	Max. speed	Max. RCF
continuous flow rotor			
Rotor R10C2	3,200 mL	10,000 rpm	14,290 × g
Rotor R18C2	1,000 mL	18,000 rpm	35,100 × g
fixed-angle rotor			
Rotor R7A	6 x 1,000 mL	7,000 rpm	11,100 × g
Rotor R9A	4 x 1,000 mL	9,000 rpm	15,300 × g
Rotor R9A2	4 x 1,500 mL	8,500 rpm	15,100 × g
Rotor R10A3	6 x 500 mL	10,000 rpm	18,800 × g
Rotor R10A5	6 x 500 mL	10,000 rpm	18,900 × g
Rotor R16A2	10 x 50 mL	16,000 rpm	36,100 × g
Rotor R16A3	6 x 250 mL	16,000 rpm	40,100 × g
Rotor R17A	14 x 50 mL	17,000 rpm	40,900 × g
Rotor R19A	6 x 80 mL	19,000 rpm	45,600 × g
Rotor R19A2	8 x 50 mL	19,000 rpm	50,000 × g
Rotor R20A2	8 x 50 mL	20,000 rpm	48,000 × g
Rotor R21A2	6 x 30 mL	21,000 rpm	50,000 × g
Rotor R22A4	30 x 2 mL	22,000 rpm	55,200 × g
Rotor R22A6	12 x 10 mL	22,000 rpm	55,100 × g
Rotor R27A	8 x 50 mL	27,000 rpm	88,400 × g
Rotor R30AT	8 x 50 mL	30,000 rpm	110,000 × g
horizontal rotor			
Rotor R10H	NA	10,000 rpm	13,000 × g
soil dehydration rotor			
Rotor R11D2	4 x 100 mL	11,000 rpm	15,800 × g
swing-bucket rotor			
Rotor R4SS	40 x 15 mL	4,000 rpm	2,900 × g
Rotor R5S4	NA	4,700 rpm	3,100 × g
Rotor R25ST	6 x 40 mL	25,000 rpm	110,000 × g

The maximum capacity refers to the nominal volume. The maximum filling volume may depend on the application, rotor and speed. Please consult with your sales representative for further details.



Separation example	Included tube/bottle	Order no.
For continuous flow harvesting of bacteria, cells or yeast for e.g. recombinant protein or antibody purification in very large volumes of >10 L.		5721352601
For continuous flow harvesting of bacteria, cells or yeast for e.g. recombinant protein or antibody purification in very large volumes of >10 L.		5721302600
For harvesting of bacteria, cells or yeast for e.g. recombinant protein or antibody purification in bottles in 6 x 1 L bottles.	6 x 1000PP bottle	5721352100
For harvesting of bacteria, cells or yeast for e.g. recombinant protein or antibody purification in bottles in 4 x 1 L bottles.	4 x 1000PP bottle	5721302114
For harvesting of bacteria, cells or yeast for e.g. recombinant protein or antibody purification in easy to handle bottles with 4 x 1.5 L.	4 x 1500PP bottle	5721302115
For harvesting of bacteria, cells or yeast for e.g. recombinant protein purification or cell compartment purification in 6 x 500 mL bottles.	6 x 500PP bottle	5721302112
For harvesting of bacteria, cells or yeast for e.g. recombinant protein purification or cell compartment purification in 6 x 500 mL Nalgene® bottles.		5721302113
For removing cellular debris or differential pelleting of subcellular organelles/compartments and easy handling in conical tubes with 10 x 50 mL.	100 x 15TC tube and 100 x 50TC tube	5721302110
For fast harvesting of bacteria, cells or yeast and removing cellular debris for e.g. recombinant protein or cell compartment purification in 6 x 250 mL bottles.	6 x 250PP bottle	5721302111
For fast removal of cellular debris or differential pelleting of subcellular organelles/compartments in tubes with 14 x 50 mL.	14 x 50PP tube with M-PP lid	5721302109
For fast removal of cellular debris or differential pelleting of subcellular organelles/compartments in tubes with 6 x 80 mL.	6 x 80PP bottle	5721302108
For differential pelleting of subcellular organelles/compartments or larger virus particles in conical tubes with 8 x 50 mL.	100 x 50TC tube	5721302107
For differential pelleting of subcellular organelles/compartments in tubes with 8 x 50 mL.	8 x 50PP tube and M-PP lid	5721221005
For differential pelleting of subcellular organelles/compartments or larger virus particles in tubes with 6 x 30 mL.	6 x 30PP bottle	5721302105
For pelleting of subcellular organelles/compartments or larger virus particles. For high throughput with 30 x 2 mL tubes.		5721302104
For pelleting of subcellular organelles/compartments or larger virus particles in tubes with 12 x 10 mL.	12 x 10PP bottle	5721302103
For pelleting of subcellular organelles/compartments or larger virus particles in tubes with 8 x 50 mL.	8 x 50PP bottle	5721302102
For pelleting and separation of small viruses, subcellular particles and vesicles in tubes with 8 x 50 mL.	8 x 50PP bottle	5721302101
For plate centrifugation for e.g. PCR or cell-free protein synthesis with up to 12 x 96 MTP.		5721302700
For liquid separation from soil or other solid organic material.		5721302800
For serum isolation, protein concentration in columns or harvesting of bacteria or cells in round bottom tubes with 40 x 15 mL.		5721352402
For plate centrifugation for e.g. ELISA or PCR in up to 12 x 96 plates.		5721302401
For pelleting or density gradient separation of subcellular organelles/compartments or virus particles in tubes with 6 x 40 mL.	50 x 40PP tube	5721302400





Ultracentrifuges - CP-NX Series

The CP-NX Centrifuge Series, the flagship of our ultracentrifuge portfolio, has been designed to make ultracentrifugation as safe and convenient as possible. With speeds of up to 803,000 x g (100,000 rpm), it is the optimal solution for nucleic acid, vesicle, organelle and virus isolation, as well as protein and nano-particle purification, just to name a few.

The centrifuge series consists of three models: Centrifuge CP100NX, CP90NX and CP80NX¹⁾, all of which share the same great range of user-friendly and innovative features along with a comprehensive rotor portfolio, making them your indispensable companion for all high- to ultra-speed applications.

The Automatic Rotor Life Management System (RLM) significantly increases the lifetime of the rotors by automatically tracking the exact run times on the internal rotor memory, making handwritten rotor logs a thing of the past. The self-locking rotor system eliminates the need to manually tighten the rotor, enabling quick and easy rotor exchange within seconds. The non-contact imbalance sensor ensures safe operation, while the possibility to balance samples by eye (up to 5 mm)²⁾ eliminates time-consuming sample balancing via scale.

The large touch display stands out with its intuitive, multilingual operation, offering three-level user management and documentation of runs. The additional option to pre-program up to 1,000 programs supports multi-user labs as well as laboratories working in GxP compliance.



¹⁾ The CP-NX models are available with max. speeds of 100,000 rpm (CP100NX)/90,000 rpm (CP90NX)/80,000 rpm (CP80NX), respectively. ²⁾ Except rotor P21A2

Learn more about
our ultracentrifuge
solutions



[www.eppendorf.link/
ultracentrifuge](http://www.eppendorf.link/ultracentrifuge)



Ordering information

Description	Order no.
Centrifuge CP100NX , refrigerated, touch interface, 230 V/50/60 Hz (no plug), 16 A	5720110012
Centrifuge CP90NX , refrigerated, touch interface, 230 V/50/60 Hz (no plug), 16 A	5720109012
Centrifuge CP80NX , refrigerated, touch interface, 230 V/50/60 Hz (no plug), 16 A	5720108012

✎ Ordering information for other voltage options can be found in the “Voltage Version” chapter.

Inquire with our service experts to install your fitting plug

Product Name	Max. capacity	Max. speed	Max. RCF	K-factor	Included tube/bottle	Order no.
fixed-angle rotor						
Rotor P21A2	6 x 230 mL	21,000 rpm	71,000 × g	486	6 x 230PP bottle	5720211205
Rotor P27A	6 x 160 mL	27,000 rpm	106,000 × g	352	6 x 160PC bottle	5720211206
Rotor P32AT	32 x 12 mL	32,000 rpm	111,000 × g	186		5720211204
Rotor P42AT	72 x 0.23 mL	42,000 rpm	223,000 × g	12	200 x 0.23PC Tube	5720211203
Rotor P45AT	6 x 94 mL	45,000 rpm	235,000 × g	130		5720211109
Rotor P50A3	24 x 1.5 mL	50,000 rpm	252,000 × g	33	300 x 1.5 mL micro tube (C)	5720211108
Rotor P50AT2	12 x 40 mL	50,000 rpm	303,000 × g	70		5720211107
Rotor P50AT4	44 x 6.5 mL	50,000 rpm	274,000 × g	38	100 x 4.7PC thick-walled tube	5720211202
Rotor P65A	10 x 12 mL	65,000 rpm	370,000 × g	48		5720211201
Rotor P70AT	8 x 40 mL	70,000 rpm	505,000 × g	44		5720211105
Rotor P70AT2	12 x 12 mL	70,000 rpm	452,000 × g	36		5720211104
Rotor P80AT	8 x 12 mL	80,000 rpm	615,000 × g	27		5720211103
Rotor P90AT	8 x 12 mL	90,000 rpm	700,000 × g	25		5720211102
Rotor P100AT2	8 x 6.5 mL	100,000 rpm	803,000 × g	18		5720211101
neo-angle rotor						
Rotor P65NT	10 x 12 mL	65,000 rpm	402,000 × g	23		5720212202
Rotor P65NT2	18 x 5 mL	65,000 rpm	431,000 × g	15		5720212203
Rotor P90NT	8 x 5 mL	90,000 rpm	646,000 × g	10		5720212201
swing-bucket rotor						
Rotor P28S	6 x 40 mL	28,000 rpm	141,000 × g	252	100 x 40PP tube	5720214005
Rotor P32ST	6 x 40 mL	32,000 rpm	180,000 × g	198	100 x 40PP tube	5720214003
Rotor P32ST2	6 x 16 mL	32,000 rpm	193,000 × g	216	100 x 16PP tubes	5720214004
Rotor P40ST	6 x 13 mL	40,000 rpm	284,000 × g	139	100 x 13PP tube	5720214002
Rotor P55ST2	6 x 5 mL	55,000 rpm	366,000 × g	50	100 x 5PP tube	5720214001
Rotor P56ST	6 x 4 mL	56,000 rpm	409,000 × g	54	100 x 4PP tube	5720214102
Rotor P65ST	3 x 5 mL	65,000 rpm	419,000 × g	48	100 x 5PP tube	5720214101
vertical rotor						
Rotor P50VT2	8 x 40 mL	50,000 rpm	243,000 × g	36		5720213103
Rotor P65VT2	16 x 5 mL	65,000 rpm	416,000 × g	10		5720213101
Rotor P65VT3	10 x 12 mL	65,000 rpm	402,000 × g	13		5720213102
Rotor P100VT	8 x 5 mL	100,000 rpm	700,000 × g	6		5720213001

The maximum capacity refers to the nominal volume. The maximum filling volume may depend on the application, rotor and speed. Please consult with your sales representative for further details.





Micro-Ultracentrifuges - CS150NX and CS150FNX

With extraordinarily high speeds of up to 1,050,000 x g (150,000 rpm), plus fast acceleration and deceleration ramps and a broad range of rotors, our micro-ultracentrifuges ensure speedy separation of samples such as nucleic acids, proteins, cell organelles, viruses and nanoparticles in volumes between 0.2 - 30 mL.

Depending on the space available, you can choose between a floorstanding model (CS150FNX) with a very compact footprint or a benchtop model (CS150NX) with standard power requirements for flexible placement within the laboratory. Both devices have a low noise level of <45 dB(A), ensuring a stress-free work environment, even when working directly next to the device.

Additional features include a rotor management and the self-locking rotor system, which enables quick and easy rotor exchange within seconds. The innovative, non-contact imbalance sensor ensures safe operation, while the possibility to balance samples by eye (up to 5 mm)¹⁾ eliminates time-consuming sample balancing via scale.

The large touch display makes operation easy, while providing enhanced security and compliance with user-based access control and documentation of runs. The ability to pre-program up to 20 programs supports multi-user labs as well as laboratories working in GxP compliance.

¹⁾ Except rotor S140AT, S110AT, S80AT3, S50A



Learn more
about our Micro-
Ultracentrifuges



[www.eppendorf.link/
micro-ultracentrifuge](http://www.eppendorf.link/micro-ultracentrifuge)



Ordering information

Description	Order no.
Centrifuge CS150FNX, refrigerated, floorstanding, touch interface, 230 V/50/60 Hz (EU), 8 A	5720121511
Centrifuge CS150NX, refrigerated, benchtop, touch interface, 230 V/50/60 Hz (EU), 8 A	5720131511

✎ Ordering information for other voltage options can be found in the “Voltage Version” chapter.

Inquire with our service experts to install your fitting plug

Product Name	Max. capacity	Max. speed	Max. RCF	K-factor	Included tube/bottle	Order no.
fixed-angle rotor						
Rotor S50A	6 x 30 mL	50,000 rpm	210,000 x g	61	20 x 25PC thick-walled tube	5720221012
Rotor S55A2	12 x 1.5 mL	55,000 rpm	201,000 x g	40	300 x 1.5 mL micro tube (C)	5720221011
Rotor S58A	8 x 13.5 mL	58,000 rpm	289,000 x g	50	20 x 10PC thick-walled tube	5720221010
Rotor S70AT	20 x 0.5 mL	70,000 rpm	307,000 x g	31	100 x 0.5PC tube	5720221009
Rotor S80AT2	30 x 0.5 mL	80,000 rpm	304,000 x g	17	100 x 0.5PC tube	5720221007
Rotor S80AT3	8 x 8 mL	80,000 rpm	415,000 x g	23	100 x 6PC thick-walled tube	5720221008
Rotor S100AT3	20 x 0.23 mL	100,000 rpm	436,000 x g	7	100 x 0.23PC tube	5720221005
Rotor S100AT4	6 x 4 mL	100,000 rpm	541,000 x g	16	100 x 3PC tube	5720221006
Rotor S110AT	8 x 5 mL	110,000 rpm	691,000 x g	15	100 x 4PC tube	5720221004
Rotor S120AT2	10 x 2 mL	120,000 rpm	650,000 x g	8	100 x 1PC tube	5720221002
Rotor S120AT3	14 x 0.5 mL	120,000 rpm	650,000 x g	8	100 x 0.5PC tube	5720221003
Rotor S140AT	10 x 2 mL	140,000 rpm	1,050,000 x g	5	100 x 1PC tube	5720221001
Rotor S150AT	8 x 2 mL	150,000 rpm	901,000 x g	6	100 x 1PC tube	5720221000
neo-angle rotor						
Rotor S100NT	8 x 4 mL	100,000 rpm	479,000 x g	12	100 x 4PP seal tube	5720222002
Rotor S120NT	8 x 2 mL	120,000 rpm	586,000 x g	9	100 x 2PP seal tube	5720222001
Rotor S140NT	8 x 2 mL	140,000 rpm	752,000 x g	6	100 x 2PP seal tube	5720222000
swing-bucket rotor						
Rotor S50ST	4 x 7 mL	50,000 rpm	253,000 x g	77	50 x 7PP tube	5720224002
Rotor S52ST	4 x 5 mL	52,000 rpm	276,000 x g	79	100 x 5PP tube	5720224001
Rotor S55S	4 x 2.2 mL	55,000 rpm	259,000 x g	44	100 x 2.2PP tube	5720224000
vertical rotor						
Rotor S120VT	8 x 2 mL	120,000 rpm	501,000 x g	8	100 x 2PP seal tube	5720223000

The maximum capacity refers to the nominal volume. The maximum filling volume may depend on the application, rotor and speed. Please consult with your sales representative for further details.





High-Speed- and Ultracentrifuge Consumables

Product Name	Nominal Volume	Compatible Rotors
Bottles		
10PC bottle assembly	10 mL	for Rotor P32AT, P45AT, P50AT2, P65A, P70AT, P70AT2, P80AT, P90AT, R10S, R14A3, R15S3, R17A, R19A, R20A2, R22A2, R22A6, S58A
10PC bottle (B) assembly	10 mL	for Rotor P32AT, P45AT, P50AT2, P65A, P70AT, P70AT2, P80AT, P90AT, R22A6, S58A
10PP bottle assembly	10 mL	for Rotor P32AT, P45AT, P50AT2, P65A, P70AT, P70AT2, P80AT, P90AT, R22A6, S58A
20PC bottle (C) assembly	20 mL	for Rotor S50A
20PP bottle (C)	20 mL	for Rotor S50A
30PC bottle (B3) assembly	30 mL	for Rotor P45AT, P50AT2, P70AT, R21A2
30PC bottle (C3) assembly	30 mL	for Rotor P45AT, P50AT2, P70AT, R21A2
30PP bottle	30 mL	for Rotor P45AT, P50AT2, P70AT, R21A2
30PP bottle assembly	30 mL	for Rotor P50AT2, P70AT
50PC bottle assembly	50 mL	for Rotor R10A3, R10S, R12A6, R13A, R14A, R16A3, R17A, R20A2, R22A2, R27A, R30AT
50PP bottle	50 mL	for Rotor R10A3, R10S, R12A3, R12A6, R13A, R14A, R16A3, R17A, R20A2, R22A2, R27A, R30AT
70PC bottle	70 mL	for Rotor R10A3, R12A3, R12A6, R13A, R14A, R14A3, R16A3, R19A
70PC bottle (B)	70 mL	for Rotor P45AT
70PC bottle (C)	70 mL	for Rotor P45AT
70PP bottle (C)	70 mL	for Rotor P45AT
80PP bottle	80 mL	for Rotor R10A3, R12A3, R12A6, R13A, R14A, R14A3, R16A3, R19A
160PC bottle without cap	160 mL	for Rotor P27A
160PP bottle without cap	160 mL	for Rotor P27A
230PP bottle	230 mL	for Rotor P21A2
250PC bottle	250 mL	for Rotor R10A3, R12A3, R12A6, R13A, R14A, R16A3, R7S
250PP bottle	250 mL	for Rotor R10A3, R12A3, R12A6, R13A, R14A, R16A3, R7S
500PP bottle including caps	500 mL	for Rotor R10A3, R12A6, R5S2
500PP seal bottle including caps	500 mL	for Rotor R10A3, R12A6
550SST bottle	500 mL	for Rotor R10A3, R12A6, R5S2
1000PC bottle (WM)	1,000 mL	for Rotor R7A, R9A
1000PC bottle assembly	1,000 mL	for Rotor R5S2
1000PP bottle (WM)	1,000 mL	for Rotor R7A, R9A
1000PP bottle assembly	1,000 mL	for Rotor R5S2
1500PP bottle (WM) assembly	1,500 mL	for Rotor R9A2

The maximum capacity refers to the nominal volume. The maximum filling volume may depend on the application, rotor and speed. Please consult with your sales representative for further details.



Material	Height	Diameter	Packaging Item Quantity	Order no.
polycarbonate	81 mm	16 mm	10	5720411027
polycarbonate	82 mm	16 mm	6	5720411026
polypropylene (PP)	82 mm	16 mm	10	5720411028
polycarbonate	80 mm	26 mm	6	5720411040
polypropylene (PP)	80 mm	26 mm	6	5720411119
polycarbonate	97 mm	26 mm	6	5720411127
polycarbonate	106 mm	29 mm	6	5720411126
polypropylene (PP)	97 mm	26 mm	10	5720411123
polypropylene (PP)	97 mm	26 mm	6	5720411124
polycarbonate	103 mm	29 mm	10	5721411009
polypropylene (PP)	106 mm	29 mm	10	5721411008
polycarbonate	104 mm	38 mm	10	5721411011
polycarbonate	106 mm	38 mm	6	5720411151
polycarbonate	103 mm	29 mm	6	5720411150
polypropylene (PP)	103 mm	29 mm	6	5720411153
polypropylene (PP)	106 mm	38 mm	10	5721411010
polycarbonate	120 mm	52 mm	10	5720411167
polypropylene (PP)	120 mm	52 mm	10	5720411168
polypropylene (PP)	125 mm	60 mm	10	5720411169
polycarbonate	124 mm	62 mm	10	5721411013
polypropylene (PP)	124 mm	62 mm	10	5721411012
polypropylene (PP)	163 mm	73 mm	4	5721411014
polypropylene (PP)	163 mm	73 mm	4	5721411015
stainless steel	165 mm	73 mm	2	5721411018
polycarbonate	170 mm	98 mm	6	5721411024
polycarbonate	180 mm	98 mm	6	5721411019
polypropylene (PP)	170 mm	98 mm	6	5721411025
polypropylene (PP)	180 mm	98 mm	6	5721411021
polypropylene (PP)	175 mm	126 mm	4	5721411035





High-Speed- and Ultracentrifuge Consumables

Product Name	Nominal Volume	Compatible Rotors
Seal tubes		
1.5PP seal tube	1.5 mL	for Rotor S120AT2, S140AT, S150AT
2PP seal tube	2 mL	for Rotor S120AT2, S120NT, S120VT, S140AT, S140NT, S150AT
4PP seal tube	4 mL	for Rotor S100AT4, S100NT
5PP seal tube	5 mL	for Rotor P100VT, P65NT2, P65VT2, P90NT, S110AT
6PP seal tube	6 mL	for Rotor P80AT, P90AT, S50ST, S58A, S80AT3
6.5PP seal tube	6.5 mL	for Rotor P100AT2, P50AT4
8PP seal tube	8 mL	for Rotor S80AT3
10PP seal tube	10 mL	for Rotor P40ST
12PP seal tube	12 mL	for Rotor P65A, P65NT, P65VT3, P70AT2, P80AT, P90AT, S58A
15PP seal tube	15 mL	for Rotor R25ST2
20PP seal tube	20 mL	for Rotor P70AT, S50A
30PP seal tube	30 mL	for Rotor P50AT2, P70AT, S50A
33PP seal tube	33 mL	for Rotor R25ST
40PP seal tube	40 mL	for Rotor P50AT2, P50VT2, P70AT
94PP seal tube	94 mL	for Rotor P45AT, R14A3
Thick-walled tubes		
0.9PC thick-walled tube	0.9 mL	for Rotor P40ST, P55ST2, P65A, P65ST, P70AT2, P80AT, P90AT, R22A6, S52ST, S58A
3PP thick-walled tube	3 mL	for Rotor S100AT4, S52ST
4PP thick-walled tube	4 mL	for Rotor S110AT
4.7PC thick-walled tube	4.7 mL	for Rotor P100AT2, P45AT, P50AT2, P50AT4, P65A, P70AT, P70AT2, P80AT, P90AT, R21A2, R22A6, R25ST2, S58A
6PC thick-walled tube	6 mL	for Rotor S80AT3
6PP thick-walled tube	6 mL	for Rotor S80AT3
10PC thick-walled tube	10 mL	for Rotor P32AT, P45AT, P50AT2, P65A, P70AT, P70AT2, P80AT, P90AT, R21A2, R22A6, S58A
10PP thick-walled tube	10 mL	for Rotor P32AT, P45AT, P50AT2, P65A, P70AT, P70AT2, P80AT, P90AT, R21A2, R22A6, S58A
11PC thick-walled tube	11 mL	for Rotor R10S, R14A3, R15S3, R17A, R19A, R20A2, R21A, R22A2
11PP thick-walled tube	11 mL	for Rotor R10S, R13A, R14A3, R15S3, R17A, R19A, R20A2, R21A, R22A2
25PC thick-walled tube	25 mL	for Rotor S50A
25PP thick-walled tube	25 mL	for Rotor S50A
33PC thick-walled tube	33 mL	for Rotor P45AT, P50AT2, P70AT, R21A2
33PP thick-walled tube	33 mL	for Rotor P45AT, P50AT2, P70AT, R21A2
Tubes		
0.23PC tube	0.23 mL	for Rotor P42AT, S100AT3
0.23PP tube	0.23 mL	for Rotor P42AT, S100AT3
0.5PC tube	0.5 mL	for Rotor S120AT3, S80AT2
0.5PC tube (B)	0.5 mL	for Rotor S70AT
0.5PP tube	0.5 mL	for Rotor S120AT3, S80AT2
1 mL test tube	1 mL	for Rotor R12A4, R22A4
1PC tube	1 mL	for Rotor S120AT2, S140AT, S150AT, S55S
1PP tube	1 mL	for Rotor S120AT2, S140AT, S150AT
2.2PET tube	2.2 mL	for Rotor S55S
2.2PP tube	2.2 mL	for Rotor S55S
3PC tube	3 mL	for Rotor P45AT, P50AT2, P55ST2, P65A, P65ST, P70AT, P70AT2, P80AT, P90AT, R21A2, R22A6, R25ST2, S100AT4, S52ST, S58A
3PP tube	3 mL	for Rotor P40ST, P65A, P70AT2, P80AT, P90AT, R25ST2, S58A
4PC tube	4 mL	for Rotor S110AT
4PET tube	4 mL	for Rotor P56ST
4PP tube	4 mL	for Rotor P40ST, P50AT2, P56ST, P65A, P70AT, P70AT2, P80AT, P90AT, R25ST2, S58A
5PET tube	5 mL	for Rotor P55ST2, P65ST, S52ST
5PP tube	5 mL	for Rotor P45AT, P50AT2, P55ST2, P65A, P65ST, P70AT, P70AT2, P80AT, P90AT, R25ST2, S52ST, S58A
5TI tube	5 mL	for Rotor S110AT

The maximum capacity refers to the nominal volume. The maximum filling volume may depend on the application, rotor and speed. Please consult with your sales representative for further details.



Material	Height	Diameter	Packaging Item Quantity	Order no.
polypropylene (PP)	24 mm	11 mm	50	5720411001
polypropylene (PP)	31 mm	11 mm	50	5720411002
polypropylene (PP)	38 mm	13 mm	50	5720411013
polypropylene (PP)	53 mm	13 mm	50	5720411008
polypropylene (PP)	42 mm	16 mm	50	5720411073
polypropylene (PP)	65 mm	13 mm	50	5720411077
polypropylene (PP)	53 mm	16 mm	50	5720411017
polypropylene (PP)	86 mm	15 mm	50	5720411088
polypropylene (PP)	78 mm	16 mm	50	5720411019
polypropylene (PP)	91 mm	16 mm	50	5720411110
polypropylene (PP)	55 mm	26 mm	50	5720411116
polypropylene (PP)	75 mm	26 mm	50	5720411121
polypropylene (PP)	88 mm	26 mm	50	5720411134
polypropylene (PP)	94 mm	26 mm	50	5720411141
polypropylene (PP)	104 mm	38 mm	25	5720411161
polycarbonate	50 mm	8 mm	50	5720411036
polypropylene (PP)	51 mm	13 mm	50	5720411014
polypropylene (PP)	60 mm	13 mm	50	5720411007
polycarbonate	64 mm	13 mm	50	5720411032
polycarbonate	59 mm	16 mm	50	5720411015
polypropylene (PP)	59 mm	16 mm	50	5720411016
polycarbonate	77 mm	16 mm	10	5720411024
polypropylene (PP)	76 mm	16 mm	10	5720411025
polycarbonate	83 mm	16 mm	10	5721411044
polypropylene (PP)	82 mm	16 mm	10	5721411043
polycarbonate	76 mm	26 mm	10	5720411038
polypropylene (PP)	76 mm	26 mm	10	5720411039
polycarbonate	89 mm	26 mm	10	5720411137
polypropylene (PP)	88 mm	26 mm	10	5720411138
polycarbonate	21 mm	7 mm	100	5720411010
polypropylene (PP)	21 mm	7 mm	100	5720411011
polycarbonate	34 mm	8 mm	100	5720411004
polycarbonate	56 mm	7 mm	100	5720411018
polypropylene (PP)	34 mm	8 mm	100	5720411005
glass	35 mm	9 mm	100	5722112042
polycarbonate	34 mm	11 mm	100	5720411000
polypropylene (PP)	34 mm	11 mm	100	5720411003
polyethylene terephthalate	34 mm	11 mm	50	5720411042
polypropylene (PP)	34 mm	11 mm	50	5720411041
polycarbonate	51 mm	13 mm	50	5720411012
polypropylene (PP)	47 mm	11 mm	50	5720411034
polycarbonate	60 mm	13 mm	50	5720411006
polyethylene terephthalate	60 mm	11 mm	50	5720411064
polypropylene (PP)	60 mm	11 mm	50	5720411033
polyethylene terephthalate	52 mm	13 mm	50	5720411043
polypropylene (PP)	52 mm	13 mm	50	5720411031
titanium	60 mm	13 mm	2	5720411273





High-Speed- and Ultracentrifuge Consumables

Product Name	Nominal Volume	Compatible Rotors
Tubes		
6.5PC tube	6.5 mL	for Rotor P100AT2, P45AT, P50AT2, P50AT4, P65A, P70AT, P70AT2, P80AT, P90AT, R25ST2, S58A
6.5PET tube	6.5 mL	for Rotor P100AT2, P45AT, P50AT2, P50AT4, P70AT
6.5PP tube	6.5 mL	for Rotor P100AT2, P45AT, P50AT2, P50AT4, P65A, P70AT, P70AT2, P80AT, P90AT, R25ST2, S58A
7PC tube	7 mL	for Rotor R22A
7PC tube (B)	7 mL	for Rotor S50ST
7PET tube	7 mL	for Rotor S50ST
7PP tube	7 mL	for Rotor S50ST
7PP tube	7 mL	for Rotor R22A
7SST tube	7 mL	for Rotor R22A
10 mL glass tube	10 mL	for Rotor R10A3, R10S, R12A3, R12A6, R13A, R14A, R16A3, R17A, R20A2, R22A2, R3S, R4SS
12PC tube	12 mL	for Rotor P32AT, P45AT, P50AT2, P65A, P70AT, P70AT2, P80AT, P90AT, R10S, R14A3, R15S3, R17A, R19A, R20A2, R22A2, S58A
12PE tube	12 mL	for Rotor P32AT, P45AT, P50AT2, P65A, P70AT, P70AT2, P80AT, P90AT, R10S, R14A3, R15S3, R17A, R19A, R20A2, R22A2, S58A
12PET tube	12 mL	for Rotor P45AT, P50AT2, P65A, P70AT
12PP tube	12 mL	for Rotor P32AT, P45AT, P50AT2, P65A, P70AT, P70AT2, P80AT, P90AT, R10S, R14A3, R15S3, R17A, R19A, R20A2, R22A2, S58A
12SST tube	12 mL	for Rotor P45AT, P50AT2, P65A, P70AT, P70AT2, P80AT, P90AT, R10S, R14A3, R15S3, R17A, R19A, R20A2, R21A2, R22A2, R22A6, S58A
12TI tube without cap	12 mL	for Rotor P70AT2, P80AT, P90AT, R22A6, S58A
13PET tube	13 mL	for Rotor P40ST
13PP tube	13 mL	for Rotor P40ST
15 mL glass tube assembly	15 mL	for Rotor R3S, R4SS
16PET tube without cap	16 mL	for Rotor R25ST2
16PP tube	16 mL	for Rotor R25ST2
30PP tube assembly	30 mL	for Rotor S50A
40PC tube	40 mL	for Rotor P28S, P32ST, R25ST
40PE tube	40 mL	for Rotor P45AT, P50AT2, P70AT
40PET tube	40 mL	for Rotor P28S, P32ST, P45AT, P50AT2, P70AT, R25ST
40PP round bottom tube	40 mL	for Rotor P28S, P32ST, P45AT, P50AT2, P70AT, R25ST
40SST tube (B) without cap	40 mL	for Rotor P28S, P32ST, P50AT2, P70AT, R21A2, R25ST
40TI tube without cap	40 mL	for Rotor P50AT2, P70AT, R21A2
50 mL glass tube assembly	50 mL	for Rotor R10A3, R12A3, R12A6, R13A, R14A, R16A3, R3S, R4SS
50PC tube	50 mL	for Rotor R10A3, R10S, R12A3, R12A6, R13A, R14A, R16A3, R17A, R20A2, R22A2, R27A, R30AT
50PP tube	50 mL	for Rotor R10A3, R10S, R12A3, R12A6, R13A, R14A, R16A3, R17A, R20A2, R22A2, R27A, R30AT
50SST tube	50 mL	for Rotor R10A3, R10S, R12A3, R12A6, R13A, R14A, R16A3, R17A, R20A2, R22A2, R27A, R30AT
50TC tube	50 mL	for Rotor R4SS, R8S, R13A, R15A, R16A2, R18A, R19A2
94PC tube	94 mL	for Rotor P45AT
94PP tube	94 mL	for Rotor P45AT
94SST tube	94 mL	for Rotor P45AT, R10A3, R12A3, R12A6, R13A, R14A, R14A3, R16A3, R19A
300SST tube	300 mL	for Rotor R10A3, R12A3, R12A6, R13A, R14A, R16A3, R7S
500PP tube	500 mL	for Rotor R3S
500SST tube	500 mL	for Rotor R10A3, R12A6, R5S2
1.5 mL micro tube (C)	1.5 mL	for Rotor P50A3, S110AT, S55A2, S80AT3
15TC tube	15 mL	for Rotor R15A, R16A2, R18A, R19A2, R8S
50TC tube	50 mL	for Rotor R13A, R15A, R16A2, R16A3, R18A, R19A2, R8S
WATSON microtube 1.5 mL	1.5 mL	for Rotor S100AT4, S110AT, S80AT3

The maximum capacity refers to the nominal volume. The maximum filling volume may depend on the application, rotor and speed. Please consult with your sales representative for further details.



Material	Height	Diameter	Packaging Item Quantity	Order no.
polycarbonate	64 mm	13 mm	50	5720411030
polyethylene terephthalate	64 mm	13 mm	50	5720411080
polypropylene (PP)	64 mm	13 mm	50	5720411029
polycarbonate	61 mm	16 mm	10	5721411038
polycarbonate	52 mm	16 mm	50	5720411045
polyethylene terephthalate	52 mm	16 mm	50	5720411046
polypropylene (PP)	52 mm	16 mm	50	5720411044
polypropylene (PP)	60 mm	16 mm	10	5721411037
stainless steel	61 mm	16 mm	2	5721411039
glass	105 mm	12 mm	50	5721411042
polycarbonate	76 mm	16 mm	50	5720411022
polyethylene	75 mm	16 mm	50	5720411021
polyethylene terephthalate	76 mm	16 mm	50	5720411106
polypropylene (PP)	76 mm	16 mm	50	5720411020
stainless steel	76 mm	16 mm	2	5720411023
titanium	76 mm	16 mm	2	5720411274
polyethylene terephthalate	96 mm	15 mm	50	5720411107
polypropylene (PP)	96 mm	15 mm	50	5720411108
glass	105 mm	16.5 mm	50	5721411050
polyethylene terephthalate	102 mm	16 mm	50	5720411113
polypropylene (PP)	102 mm	16 mm	50	5720411112
polypropylene (PP)	72 mm	26 mm	50	5720411037
polycarbonate	90 mm	26 mm	50	5720411140
polyethylene	89 mm	26 mm	50	5720411146
polyethylene terephthalate	90 mm	26 mm	50	5720411148
polypropylene (PP)	90 mm	26 mm	50	5720411139
stainless steel	90 mm	26 mm	2	5720411147
titanium	90 mm	26 mm	2	5720411149
glass	100 mm	35 mm	10	5721411059
polycarbonate	103 mm	29 mm	10	5721411057
polypropylene (PP)	104 mm	29 mm	10	5721411056
stainless steel	10.2 mm	29 mm	2	5721411058
			100	5721411170
polycarbonate	101 mm	38 mm	25	5720411164
polypropylene (PP)	101 mm	38 mm	25	5720411160
stainless steel	101 mm	38 mm	2	5720411165
stainless steel	128 mm	62 mm	2	5721411063
polypropylene (PP)	108 mm	103 mm	4	5721411064
stainless steel	150 mm	73 mm	2	5721411065
polypropylene (PP)	40 mm	11 mm	300	5720411009
polypropylene (PP)	120 mm	17 mm	100	5721411049
polypropylene (PP)	115 mm	30 mm	300	5721411067
polypropylene (PP)	42 mm	10.8 mm	1,000	5720411052



PCR



Brandnew Mastercycler X40 - Raise Your Standard

Whether your application involves genome editing, NGS library preparation, cloning, or virus detection, a PCR thermocycler is required. Traditional end-point PCR is utilized in virtually every molecular biology laboratory where the need for optimal performance, and fast, reproducible results is crucial.

Key features of a high-quality thermocycler include durability, versatility, speed and throughput. When choosing a cyclor based on such characteristics, it is additionally important to think about the block material and configuration. Choose from multiple block configurations utilizing either a silver block with good heat conducting properties for increased speed or traditional aluminum blocks with 96 or 384 wells. We also offer the Mastercycler® nexus X2 with a dual block for running PCR reactions in parallel.

Depending on your lab's needs, you require different vessel types and a cyclor that is compatible with both tube and plate formats. Our Mastercycler® X50 and Mastercycler® nexus X2 utilize flexlid® technology that guarantees optimal pressure for a tight seal of your sample plates or tubes in the block to eliminate evaporation. In contrast the new Mastercycler® X40 has a newly developed SafeLid to protect your samples from evaporation in tubes and plates.

For added flexibility and efficiency, the 2D-Gradient of the Mastercycler® X50 enables you to optimize the annealing and denaturation temperature. This enables optimization of specificity and yield by testing 96 temperature combinations in only one PCR run. If you need support for further optimization of your PCR protocols, we have articles that explain the technological background of cyclor technology and different ways to improve your PCR.



Connect multiple thermocyclers to increase capacity.

Optimize your
PCR set-up



[www.eppendorf.link/
PCR-productivity](http://www.eppendorf.link/PCR-productivity)

Get all information about the Eppendorf PCR portfolio!
Explore the eshop and get an overview!
www.eppendorf.link/PCR-portfolio



For high throughput or expanding labs, we also offer eco units that can be connected to one main cycler. The Mastercycler® X50 can control up to 9 eco units directly. For even more throughput you may connect up to 50 eco unit devices and conveniently control them via the CycleManager X50 software. With Mastercycler nexus X2 you can connect up to 3 cyclers to increase productivity. Become a digital, connected lab and monitor multiple lab devices with VisioNize®. The touchscreen interface of Mastercycler® X50 and X40 enables using VisioNize® for your digital future. You can manage users, audits and PCR runs easily from the device, a PC or smartphone and tablet.

We also offer distinguished service plans to ensure preventive maintenance of your thermal cycler assessing factors such as temperature block homogeneity. You may also use the temperature verification system TVS-T6 to check the block temperature of your cyclers yourself for minimal device downtime and regular temperature verification.

Learn more about
the CycleManager
X50 software

[www.ependorf.link/
cyclemanager-software](http://www.ependorf.link/cyclemanager-software)



Run two separate PCRs at the same time with Mastercycler® nexus X2



Mastercycler X50 for increased speed and throughput



Download the Mastercycler® family brochure
www.ependorf.link/PCR-brochure



PCR

PCR consumables



Eppendorf twin.tec® plates are available in different colors.

The Eppendorf twin.tec® PCR plate combines extremely thin-walled polypropylene wells for optimal heat transfer to the sample with robust polycarbonate frames for high rigidity. With raised well rims, twin.tec plates enable highly effective sealing to reduce the risk of cross-contamination.

The heart of our PCR consumables is the Eppendorf twin.tec® PCR plate. It is available in a 96-well or 384-well format. All of the 96-well plates are offered in three different frame variants: unskirted and, skirted to perfectly fit your instruments. The plates are

also available in standard or LoBind® quality and additional variations such as low profile to suit multiple applications. We also supply a range of PCR tubes, films, foils, tube strips, and cap strips.

All PCR consumables are made of high-purity plastics and are 'PCR clean'. This means they are batch-tested and certified by an independent laboratory to be free of a range of common PCR contaminants, including DNA, DNase, RNase, and PCR inhibitors. Products that are labeled 'forensic DNA grade' fulfill the requirements for ISO 18385.

The special design and manufacturing process results in high precision products. Every single plate is a high-performance component in your workflow offering superior reproducibility.

The plate portfolio also includes plates for real-time PCR with white wells and individually wrapped microbiology plates. Those plates are specially designed for these methods and research areas, helping you to achieve the best possible results.

All Eppendorf Plates are available with customized barcodes.



Different frame formats of Eppendorf twin.tec® plates: unskirted (top), semi-skirted (middle) and skirted (bottom).



Eppendorf twin.tec[®] Trace PCR Plates



With their laser-engraved lot and expiration date, twin.tec Trace PCR plates are ideally suited for your complex studies, automated high-throughput applications and regulated workflows. They support traceability and documentation for your next audit.

In addition to their high-throughput and compliance features, these microtiter plates come with a laser-engraved optical guiding grid and OptiTrack[®] matrix that ensure quick well-orientation when you are pipetting manually.

Product features

- > Laser-engraved lot number and expiration date on each single plate to improve traceability in your laboratory processes
- > Unique laser-engraved optical guiding grid and OptiTrack[®] matrix for quick orientation when pipetting manually
- > One-piece design: combining a polycarbonate frame and polypropylene wells for optimum performance

Available in transparent and 2 fresh colors twin.tec Trace plates are ready to deliver maximum performance and reliability for your most demanding workflows!

All Eppendorf twin.tec Trace plates are 'PCR clean', having been batch-tested and certified by an independent and accredited laboratory to be free of a range of common PCR contaminants, including DNA, RNA, DNase, RNase, and PCR inhibitors. With these microplates you'll have maximum confidence in your results.



Get all information about twin.tec Trace

www.eppendorf.link/twintec-Trace

Our Selection – Your Choice



Model	MC X50s	MC X50a	MC X50i
Page(s)	8	8	9
Dimensions (W × D × H)	27.5 × 43 × 33 cm / 10.8 × 16.9 × 13 in	27.5 × 43 × 33 cm / 10.8 × 16.9 × 13 in	27.5 × 43 × 33 cm / 10.8 × 16.9 × 13 in
2D-Gradient block	over 12 columns/over 8 rows	over 12 columns/over 8 rows	over 12 columns/over 8 rows
Gradient block	–	–	–
Heating rate	10 °C/s	5 °C/s	10 °C/s
Cooling rate	5 °C/s	2.3 °C/s	5 °C/s
Interfaces	Ethernet, USB	Ethernet, USB	Ethernet, USB
Lid descent	flexlid® technology with TSP	flexlid® technology with TSP	flexlid® technology with TSP
Lid temperature range	37 – 110 °C	37 – 110 °C	37 – 110 °C
Sample capacity	96-well plate or 0.1/0.2 mL tubes	96-well plate or 0.1/0.2 mL tubes	96-well plate or 0.1/0.2 mL tubes
Gradient temperature control range	30 – 99 °C	30 – 99 °C	30 – 99 °C
Temperature control range of the block	4 – 99 °C	4 – 99 °C	4 – 99 °C
Thermoblock	Silver	Aluminum	Silver
Remote Device Monitoring and Notifications (VisioNize®)	VisioNize® touch enabled	VisioNize® touch enabled	VisioNize® touch enabled

¹⁾ measured at the block

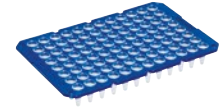
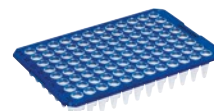

Model	Eppendorf twin.tec® PCR Plate 96 skirted	Eppendorf twin.tec® PCR Plate 96 semi-skirted	Eppendorf twin.tec® PCR Plate 96 unskirted	Eppendorf twin.tec® PCR Plate 96 unskirted, divisible
Page(s)	12	12	12	12
Number of wells	96 wells	96 wells	96 wells	96 wells
Total volume per well	150 µL	250 µL	150 or 250 µL	150 or 250 µL
OptiTrack® frame color	colorless yellow green blue red	colorless yellow green blue red	colorless blue	colorless blue

Get all information about the Eppendorf PCR portfolio!
 Get all information about the Eppendorf PCR portfolio!
 Jump into the e-shop and get an overview!





New



MC X40	MC nexus GX2
10	11
24.5 × 38.5 × 23 cm / 9.7 × 15.2 × 9.1 in	25 × 41.2 × 33 cm / 9.8 × 16.2 × 13 in
over 12 columns	–
–	Over 8 rows (0.2 mL)
3.3 °C/s	3 °C/s ¹⁾
1.5 °C/s	2 °C/s ¹⁾
Ethernet, USB	CAN_in/CAN_out, Ethernet, USB
SafeLid	flexlid® technology, with TSP
37 – 110 °C	37 – 110 °C
96-well plate or 0.1/0.2 mL tubes	64/32 × 0.2 mL PCR tubes or up to 24/10 × 0.5 mL PCR tubes
30 – 99 °C	30 – 99 °C
4 – 99 °C	4 – 99 °C
Aluminum	Aluminum
VisioNize® touch enabled	VisioNize® box enabled



Eppendorf twin.tec® PCR Plate 384	Eppendorf twin.tec® PCR Plate LoBind®	Eppendorf twin.tec® PCR Plate, Forensic DNA Grade	Eppendorf twin.tec® 96 real-time PCR Plate
12	13	12	14
384 wells	96 wells 384 wells	96 wells 384 wells	96 wells
45 µL	150 or 250 µL 45 µL	150 or 250 µL 45 µL	150 or 250 µL
colorless	colorless colorless	colorless colorless	white
yellow	yellow		blue
green	green		
blue	blue		
red	red		



Mastercycler® X50

Description

The Mastercycler® X50 elegantly combines speed, flexibility, and ease of use. With its intuitive touch screen offering precise fingertip control, the MC X50 thermocycler enables easy PCR optimization in advanced molecular biology research and dependable standardization in routine PCR applications. It is also perfectly fitted for NGS.



Product features

- > Heating rate: up to 10 °C/s
- > Wide selection of blocks from a fast silver block to 384 well block
- > VisioNize® touchscreen interface

Applications

- > Fast PCR
- > PCR optimization
- > Standard PCR
- > Incubation
- > Cycle sequencing

Shop now for
Mastercycler® X50



[www.eppendorf.link/
Mastercycler-X50](http://www.eppendorf.link/Mastercycler-X50)

Ordering information

Description	Order no.
Mastercycler® X50s, 110 – 230 V/50 – 60 Hz (GB), silver block, 96-well plate or 0.1/0.2 mL tubes, with touchscreen interface	6311000045
Mastercycler® X50a, 110 – 230 V/50 – 60 Hz (GB), aluminum block, 96-well plate or 0.1/0.2 mL tubes, with touchscreen interface	6313000042
Mastercycler® X50h, 110 – 230 V/50 – 60 Hz (GB), aluminum block, 1 PCR plate 384, high pressure lid, with touchscreen interface	6316000043

✎ Ordering information for other voltage options can be found in the “Voltage Version” chapter.



Mastercycler® X50, eco unit



Description

Mastercycler® X50 eco units combine the speed and performance of the master device with the option to be connected to each other. Up to 9 units can be controlled by one master device, while up to 50 eco units can be conveniently controlled with the CycleManager X50 software, even if they are placed in multiple laboratories.

Product features

- > Heating rate: up to 10 °C/s
- > Cooling rate above RT: 5 °C/s
- > Control up to 50 units from one PC

Applications

- > Fast PCR
- > PCR optimization
- > Standard PCR
- > Incubation
- > Cycle sequencing

Ordering information

Description	Order no.
Mastercycler® X50i, 110 – 230 V/50 – 60 Hz (GB), silver block, 96-well plate or 0.1/0.2 mL tubes, eco unit	6301000047
Mastercycler® X50i, 110 – 230 V/50 – 60 Hz (GB), aluminum block, 96-well plate or 0.1/0.2 mL tubes, eco unit	6303000044
Mastercycler® X50t, 110 – 230 V/50 – 60 Hz (GB), aluminum block, 1 PCR plate 384, high pressure lid, eco unit	6306000045

✎ Ordering information for other voltage options can be found in the “Voltage Version” chapter.

CycleManager X50 Software



Simple, Central, Smart ...

Mastercycler X50

with CycleManager X50 Software

50x

Description

Maximize your PCR efficiency. CycleManager X50 enables you to increase your throughput by managing up to fifty Mastercycler X50 eco units simultaneously. Now there's no need for repetitive copying of PCR documentation and parameters, time-consuming searches for an available cycler, or checking the status of your runs on multiple cyclers. Address this bottleneck in your workflow and get full PCR control with CycleManager X50 software.

Ordering information

Description	Order no.
CycleManager X50 Software	6349000014





Mastercycler® X40

Description

Boost academic research – Take your lab to the future with the Mastercycler® X40. Programming is easy with the touchscreen and proven Mastercycler software while monitoring and connectivity with VisioNize® make the PCR cycler ready for your digital lab.

The Mastercycler® X40 enables reliable, stable and reproducible PCR runs on a small footprint. New protocols and primers are no problem with the efficient 12-column gradient for optimization. A convenient heating rate of up to 3.3 °C/s suits also sensitive DNA samples.

New



Product features

- > 12-column gradient
- > SafeLid for evaporation protection
- > Small footprint (less than a piece of paper)

Applications

- > End-point PCR
- > Cycle sequencing
- > PCR optimization
- > Incubation

Browse the
website of the new
Mastercycler X40



[www.eppendorf.link/
raiseyourstandard](http://www.eppendorf.link/raiseyourstandard)

Ordering information

Description

Mastercycler® X40, 100 – 240 V/50 – 60 Hz (GB), aluminum block, 96-well plate or 0.1/0.2 mL tubes, with touchscreen interface

Order no.

[6381000042](https://www.eppendorf.com/6381000042)

✎ Ordering information for other voltage options can be found in the “Voltage Version” chapter.



Mastercycler® nexus X2

Description

The Mastercycler® nexus X2 is Eppendorf's solution for busy PCR labs. Two totally independent protocols can be run on the nexus X2 in parallel so two users can start their PCR reactions whenever it fits their schedule. With less than 40 dB[a] noise emission, the nexus X2 PCR cyclers are whisper quiet and also very energy efficient.



Product features

- > Asymmetrically divided block for running different assays in parallel, one 32-well and one 64-well block
- > Intuitive graphic programming
- > Universal block for strips, 0.1 mL, 0.2 mL and 0.5 mL PCR tubes and fits for divisible PCR plates

Applications

- > Standard PCR
- > PCR optimization

Discover its advantages



[www.eppendorf.link/
Mastercycler-nexus-x2](http://www.eppendorf.link/Mastercycler-nexus-x2)

Ordering information

Description	Order no.
Mastercycler® nexus GX2, 230 V/50 – 60 Hz (GB)	6336000040
Mastercycler® nexus GX2e, 230 V/50 – 60 Hz (GB)	6338000047
Mastercycler® nexus X2, 230 V/50 – 60 Hz (GB)	6337000043
Mastercycler® nexus X2e, 230 V/50 – 60 Hz (GB)	6339000040

✎ Ordering information for other voltage options can be found in the “Voltage Version” chapter.





PCR Consumables and Sealing



New

New

Eppendorf twin.tec® PCR Plates

Choose Eppendorf twin.tec® PCR plates for confidence in every PCR assay. twin.tec® plates offer purity, rigidity, color, and other simple, smart features can make your daily life a lot easier. The rigid polycarbonate frame works well in automation and high-throughput processes, and the different colors mean you can quickly organize the different steps of your workflow.

All plates also available as barcoded version.

Ordering information

Description	Order no.
Eppendorf twin.tec® Trace PCR Plate 96 , skirted, 150 µL	
PCR clean, colorless, 25 plates	0030129768
PCR clean, crystal blue, 25 plates	0030129776
PCR clean, fuchsia, 25 plates	0030129784
Eppendorf twin.tec® Trace PCR Plate 384 , skirted, 45 µL	
PCR clean, colorless, 25 plates	0030129792
Eppendorf twin.tec® PCR Plate 96 , skirted, 150 µL	
PCR clean, colorless, 25 plates	0030128648
PCR clean, yellow, 25 plates	0030128656
PCR clean, green, 25 plates	0030128664
PCR clean, blue, 25 plates	0030128672
PCR clean, red, 25 plates	0030128680
Forensic DNA Grade, colorless, 10 plates, individually wrapped	0030129601
Eppendorf twin.tec® PCR Plate 96 , semi-skirted, 250 µL	
PCR clean, colorless, 25 plates	0030128575
PCR clean, yellow, 25 plates	0030128583
PCR clean, green, 25 plates	0030128591
PCR clean, blue, 25 plates	0030128605
PCR clean, red, 25 plates	0030128613
Forensic DNA Grade, colorless, 10 plates, individually wrapped	0030129610
Eppendorf twin.tec® PCR Plate 384 , skirted, 45 µL	
PCR clean, colorless, 25 plates	0030128508
PCR clean, yellow, 25 plates	0030128516
PCR clean, green, 25 plates	0030128524
PCR clean, blue, 25 plates	0030128532
PCR clean, red, 25 plates	0030128540
Forensic DNA Grade, colorless, 10 plates, individually wrapped	0030129628
Eppendorf twin.tec® PCR Plate 96, low profile , unskirted, 150 µL	
PCR clean, colorless, 20 plates	0030133307
PCR clean, blue, 20 plates	0030133331
Eppendorf twin.tec® PCR Plate 96 , unskirted, 250 µL	
PCR clean, colorless, 20 plates	0030133366
PCR clean, blue, 20 plates	0030133390
Eppendorf twin.tec® PCR Plate 96, divisible , unskirted, divisible, 150 µL	
PCR clean, colorless, 20 plates	0030133358
PCR clean, blue, 20 plates	0030133382
Eppendorf twin.tec® PCR Plate 96, divisible , unskirted, divisible, 250 µL	
PCR clean, colorless, 20 plates	0030133374
PCR clean, blue, 20 plates	0030133404
Eppendorf twin.tec® microbiology PCR Plate 96 , skirted, 150 µL	
PCR clean, colorless, 10 plates	0030129300
PCR clean, blue, 10 plates	0030129318
Eppendorf twin.tec® microbiology PCR Plate 96 , semi-skirted, 250 µL	
PCR clean, colorless, 10 plates	0030129326
PCR clean, blue, 10 plates	0030129334
Eppendorf twin.tec® microbiology PCR Plate 384 , skirted, 45 µL	
PCR clean, colorless, 10 plates	0030129342
PCR clean, blue, 10 plates	0030129350



Ordering information

Description	Order no.
Eppendorf twin.tec® PCR Plate 96 , skirted, 150 µL	
PCR clean, colorless, 300 plates	0030128770
PCR clean, green, 300 plates	0030128796
PCR clean, yellow, 300 plates	0030128788
PCR clean, blue, 300 plates	0030128842
PCR clean, red, 300 plates	0030128850
Eppendorf twin.tec® PCR Plate 96 , semi-skirted, 250 µL	
PCR clean, colorless, 300 plates	0030128869
Eppendorf twin.tec® PCR Plate 384 , 45 µL	
PCR clean, colorless, 300 plates	0030128931
PCR clean, yellow, 300 plates	0030128940
PCR clean, green, 300 plates	0030128958
PCR clean, blue, 300 plates	0030128966
PCR clean, red, 300 plates	0030128974



Eppendorf twin.tec® PCR Plates LoBind®

Get the most out of your PCR. Eppendorf's twin.tec® PCR plates LoBind® are specially designed to maximize the yield of your target molecules. LoBind wells are made of polypropylene, with low DNA binding properties, leading to reduced loss of target molecules and higher yields in PCR and other molecular assays.

Ordering information

Description	Order no.
Eppendorf twin.tec® Trace LoBind® PCR Plate 96 , skirted, 150 µL	
PCR clean, colorless, 25 plates	0030129822
Eppendorf twin.tec® PCR Plate 96 LoBind® , skirted, 150 µL	
PCR clean, colorless, 25 plates	0030129512
PCR clean, red, 25 plates	0030129598
PCR clean, blue, 25 plates	0030129580
PCR clean, yellow, 25 plates	0030129679
PCR clean, green, 25 plates	0030129660
Eppendorf twin.tec® PCR Plate 96 LoBind® , skirted	
PCR clean, yellow, 300 plates	0030129563
PCR clean, orange, 300 plates	0030129571
PCR clean, green, 300 plates	0030129555
Eppendorf twin.tec® PCR Plate 96 LoBind® , semi-skirted, 250 µL	
PCR clean, colorless, 25 plates	0030129504
Eppendorf twin.tec® PCR Plate 384 LoBind® , skirted, 45 µL	
PCR clean, colorless, 25 plates	0030129547

Learn more about
LoBind® technology

[www.eppendorf.link/
howitworks-lobind](http://www.eppendorf.link/howitworks-lobind)





PCR Consumables and Sealing



Eppendorf twin.tec® *real-time* PCR Plates

The white wells of Eppendorf's twin.tec® real-time PCR plates increase the reflection of fluorescent light in real-time PCR (qPCR) and other fluorescence assays. The increased fluorescence from these specialized qPCR plates improves the sensitivity of your assays, while also improving reproducibility and consistency of your results.

Ordering information

Description	Order no.
Eppendorf twin.tec® 96 <i>real-time</i> PCR Plate, skirted, 150 µL	
PCR clean, blue, wells white, 25 plates	0030132505
PCR clean, white, wells white, 25 plates	0030132513
Forensic DNA Grade, white, wells white, 10 plates, individually wrapped	0030129636
Eppendorf twin.tec® 96 <i>real-time</i> PCR Plate, semi-skirted, 250 µL	
PCR clean, blue, wells white, 25 plates	0030132530
PCR clean, white, wells white, 25 plates	0030132548
Forensic DNA Grade, white, wells white, 10 plates, individually wrapped	0030129644
Eppendorf twin.tec® 96 <i>real-time</i> PCR Plate, unskirted, low profile, 150 µL	
PCR clean, white, wells white, 20 plates	0030132700
PCR clean, blue, wells white, 20 plates	0030132718



PCR Consumables and Sealing



Eppendorf PCR Tubes

Since 1963, when Eppendorf invented the microcentrifuge tube, Eppendorf tubes have proven to be reliable companions in a scientist's daily work. Eppendorf PCR tubes are easy to open and provide tight sealing to prevent evaporation in PCR. With their thin, consistent wall thickness and smooth wall surface, they also ensure efficient heat transfer to the sample, speeding up your PCR.

Ordering information

Description	Order no.
Eppendorf PCR Tube Strips, 0.1 mL	
PCR clean, without lids (10 × 12 strips)	0030124804
PCR clean, with Cap Strips, domed (10 × 12 strips)	0030124812
PCR clean, with Cap Strips, flat (10 × 12 strips)	0030124820
Eppendorf PCR Tubes, 0.2 mL	
PCR clean, colorless, 1,000 pcs.	0030124332
Forensic DNA Grade, colorless, 500 pcs. (5 bags × 100 pcs.)	0030124707
Eppendorf PCR Tube Strips, 0.2 mL	
PCR clean, 8-tube strips, 120 pcs. (960 tubes)	0030124359
Eppendorf PCR Tubes, 0.5 mL, PCR clean, with hinged lid, clear, 500 pcs.	0030124537

Eppendorf Fast PCR Tube Strips

The Eppendorf Fast PCR Tube Strips are made of polyethylene to transfer heat faster than tubes made of traditional plastics. These PCR strips with caps are particularly suited to fast PCR, for example using fast PCR reagent kits or cyclers with high heating and cooling rates, such as the Mastercycler® X50 family.

Ordering information

Description	Order no.
Eppendorf Fast PCR Tube Strips	
0.1 mL, without lids, PCR clean, 120 pcs. (10 × 12 pcs.)	0030124901
0.1 mL, with cap strips, flat, PCR clean, 120 pcs. (10 × 12 pcs.)	0030124910
0.1 mL, with cap strips, domed, PCR clean, 120 pcs. (10 × 12 pcs.)	0030124928

PCR cap strips

Eppendorf Cap Strips provide easy and rapid sealing of Eppendorf twin.tec® PCR plates, PCR tubes and other standard multiwell plates. Each strip has eight PCR caps for use on 0.1 mL and 0.2 mL wells.

PCR Cap Strips can also be used in real-time PCR (qPCR) assays. In this case it is recommended to use flat capped strips or Masterclear® strips for maximal transparency. If you encounter evaporation and sample loss, domed caps can be used to provide a tighter seal when using a heated lid. Eppendorf Cap Strips can be sterilized by autoclaving for 20 minutes at 121 °C.

Ordering information

Description	Order no.
Cap Strips, 8-strips, domed, 120 pcs. (10 bags × 12 pcs.)	0030124839
Cap Strips, 8-strips, flat, 120 pcs. (10 × 12 pcs.)	0030124847
real-time PCR Tube Strips, without caps, 120 pcs. (10 × 12 pcs.)	0030132882
Masterclear® Cap Strips and real-time PCR Tube Strips, 120 pcs. (10 × 12 pcs.)	0030132890
Masterclear® Cap Strip, 120 pcs. (10 × 12 pcs.)	0030132874





PCR Consumables and Sealing

PCR-Cooler

Say goodbye to unstable racks and ice buckets at your bench. The PCR racks are ideal for safe sample transport and storage while the PCR-Cooler is perfect for keeping your samples cold throughout your PCR setup without using ice. Suitable for 0.2 mL and 0.5 mL PCR tubes and for 96-well PCR plates.



Ordering information

Description	Order no.
PCR-Cooler 0.2 mL Starter Set, 1 pink, 1 blue	3881000015
PCR-Cooler 0.2 mL, Pink	3881000023
PCR-Cooler 0.2 mL, Blue	3881000031

PCR-Rack

Handling several PCR tubes or tube strips can be cumbersome. Eppendorf PCR racks are a great help when dealing with numerous 0.1, 0.2, and 0.5 mL tubes and strips. The racks are stackable, can be stored down to -90°C and can be autoclaved.



Ordering information

Description	Order no.
PCR-Rack, assorted colors, 10 pcs.	0030124545

PCR films & foils

Eppendorf PCR films and foils provide effective and airtight sealing for plates to help protect PCR samples during thermal cycling and storage. PCR plate seals offer excellent chemical resistance and have been tested for resistance to a variety of common laboratory substances. Specialized seals with optimal optical properties are available to help minimize signal loss in qPCR.



Ordering information

Description	Order no.
Eppendorf Heat Sealing Film, PCR clean, 100 pcs.	0030127838
Eppendorf Heat Sealing Foil, PCR clean, 100 pcs.	0030127854
Eppendorf PCR Film, self-adhesive, PCR clean, 100 pcs.	0030127781
Eppendorf PCR Foil, self-adhesive, PCR clean, 100 pcs.	0030127790
Masterclear® <i>real-time</i> PCR Film, self-adhesive, PCR clean, 100 pcs.	0030132947



HeatSealer



To obtain reliable assay results, PCR plates need to be sealed tightly in a reproducible manner – and the same is true for maintaining sample integrity during storage. The HeatSealers S100 and S200 are user friendly instruments for reliable plate sealing of different plate formats. In combination with our range of adapters, Eppendorf HeatSealers enable you to seal almost any plate.

Ordering information

Description	Order no.
HeatSealer S100, incl. PCR Plate Adapter, 100 – 230 V/50 – 60 Hz (GB)	5391000036
HeatSealer S200, incl. PCR Plate Adapter, 100 – 230 V/50 – 60 Hz (GB)	5392000030
Plate Adapter low profile, for HeatSealer S100	5391070018
Plate Adapter high profile, for HeatSealer S100	5391070034
96-well-PCR Plate Adapter, for HeatSealer S100	5391070026
Plate Adapter high profile, for HeatSealer S200	5392070011
Plate Adapter low profile, for HeatSealer S200	5392070020
96-well Plate Adapter, for HeatSealer S200	5392070038
Eppendorf Heat Sealing Film, PCR clean, 100 pcs.	0030127838
Eppendorf Heat Sealing Foil, PCR clean, 100 pcs.	0030127854

✎ Ordering information for other voltage options can be found in the “Voltage Version” chapter.



Freezers

Cold Storage – Protect what Matters



How Much Effort Did You Spend on Your Sample?

Did you ever calculate the value within your freezer? All the hours, days, weeks, and months spent on your samples? More than 50,000 samples fit into a large, standard ULT (also known as ultra-low temperature freezer, -80°C). The value of every single sample differs – from simple buffers to high-value clones, expensive enzymes, or very rare sample material. When predominantly storing

high-value samples which are a result of months of work – a single freezer can easily reach a value equal to hundreds of thousands of Euros or dollars. Your ULT freezer is not just a storage room for samples. This instrument is your assurance for long-term scientific success, securing your work.

Confidence in Quality

Eppendorf has a long-standing history of innovation and quality, and our freezer manufacturing process is no exception. Each Eppendorf ULT freezer is thoroughly inspected to meet our rigorous quality guidelines. The final inspection takes more than 24h and is based on manual and visual technical checks. This process is documented by an individual certificate of quality, completed with serial number, provided as standard for your documentation.

As your expert partner for reliable, high-quality, and efficient storage solutions, Eppendorf finely engineers each freezer with care, using only the highest quality materials to ensure a long lasting freezer that offers peace of mind and security. Performance data are based on external test runs of 3 units.

Eppendorf freezers are designed to offer a long-term value over the lifetime of its ownership. You can entrust your valuable samples to our ULT freezers, and you can trust your investment in high quality, reliable, and efficient storage solutions from Eppendorf.



Get all information about the Eppendorf freezer portfolio!
Explore the eshop and get an overview!
www.eppendorf.link/freezer-portfolio



Our Part for Sustainability

- > ENERGY STAR® and ACT® label (My Green Lab®) partner
- > 100% renewable power usage in our production facility
- > Production based on high European social and environmental standards
- > Environmentally-friendly insulation with green foam, vacuum insulation panels („h“-version), and insulated inner doors for energy efficiency
- > Green cooling liquids (Hydrocarbons: R170/ R290) with very low global warming potential (GWP) — to comply with the European F-Gas regulation and US SNAP regulations
- > Over a decade of experience at Eppendorf with green hydrocarbon-based cooling liquids for -80 °C applications in R&D, production, logistics, and service in the field
- > Low energy consumption combined with efficient cooling performance and long freezer lifespan that you can rely on



Please use the QR-Code to get more Information



www.eppendorf.link/sustainability

Digitalization of Cold Storage



Remember Your Last 2 a.m. Wake-up Call?

VisioNize® Lab Suite is your central software solution for effective monitoring and maintenance management to prevent sample storage emergencies. Benefit from 24/7 notification & monitoring for your ULT freezers and high-value stored samples



Independent Temperature Measurement Required?

With VisioNize sense, you can connect non-Eppendorf devices to VisioNize Lab Suite or utilize the sensor system as a second source of validation for monitoring the temperature in your freezer.



Lost in Samples? Stay Organized!

Over many years, you collect and handle many samples – samples of high value. Keep track of your samples with eLabNext®, the sample management software



Digitalization at Eppendorf
www.eppendorf.link/digitalabsolutions



Explore the digital freezer rack configurator
<https://econfig.bio-itech.de/>

Our Portfolio – Your Choice



Model	CryoCube® F740hi, 3 c./ CryoCube® F740hi, 5 c.	CryoCube® F740hiw, 3 c./ CryoCube® F740hiw, 5 c.	CryoCube® F740h, 3c./ CryoCube® F740h, 5c.
Insulation	vacuum insulation paneling / polyurethane foam	vacuum insulation paneling / polyurethane foam	vacuum insulation paneling / polyurethane foam
Wall Thickness¹⁾	type B	type B	type B
Capacity	740 L (26.1 ft ³)	740 L (26.1 ft ³)	740 L (26.1 ft ³)
No. of internal doors	3	3	3
No. of compartments	3/5	3/5	3/5
Max. racks per freezer	18/30	18/30	18/30
Box capacity per rack			
53 mm (2 in) tall boxes	32/16	32/16	32/16
76 mm (3 in) tall boxes	20/8	20/8	20/8
102 mm (4 in) tall boxes	16/8	16/8	16/8
Box capacity per freezer			
53 mm (2 in) tall boxes	576/528	576/528	576/528
76 mm (3 in) tall boxes	360/288	360/288	360/288
102 mm (4 in) tall boxes	288/264	288/264	288/264
Sample capacity			
53 mm (2 in) samples	57,600/52,800	57,600/52,800	57,600/52,800
Dimensions (W × D × H)²⁾³⁾⁴⁾	111 × 98.0 × 197.3 cm / 43.7 × 38.6 × 77.7 in	111 × 98.0 × 197.3 cm / 43.7 × 38.6 × 77.7 in	111 × 91.3 × 197.3 cm / 43.7 × 36 × 77.7 in
Dimensions internal (W × D × H)	86.5 × 62.1 × 139 cm / 34.1 × 24.5 × 54.7 in	86.5 × 62.1 × 139 cm / 34.1 × 24.5 × 54.7 in	86.5 × 62.1 × 139 cm / 34.1 × 24.5 × 54.7 in
Weight w/o accessories	315 kg / 694 lb/333 kg / 734 lb	320 kg / 705 lb/328 kg / 723 lb	308 kg / 679 lb/317 kg / 699 lb
Shipping weight	364 kg / 787 lb/382 kg / 806 lb	369 kg / 787 lb/377 kg / 806 lb	357 kg / 787 lb/366 kg / 806 lb
Pull-down time to -80 °C⁵⁾	4 h 10 min	4 h 10 min	4 h 10 min
Noise level	41.3 dB	41.3 dB	47.8 dB
Power supply	100 – 230 V, 50/60 Hz	100 – 230 V, 50/60 Hz	100 – 230 V, 50/60 Hz
Average Daily Consumption (115 V)	11.6 kWh/day	10.6 kWh/day	13 kWh/day
Average Daily Consumption (208 V)	10.5 kWh/day	10.6 kWh/day	11.8 kWh/day
Average Daily Consumption (230 V)	10.5 kWh/day	11.7 kWh/day	11.8 kWh/day
Interior (shelves + chamber)	Stainless steel	Stainless steel	Stainless steel
Password protection of parameters	yes	yes	yes
Extras	Automatic vent port	Automatic vent port	Automatic vent port
Cooling liquid	R290 / R170	R290 / R170	R290 / R170
Remote Device Monitoring and Notifications (VisioNize®)	VisioNize® touch enabled	VisioNize® touch enabled	VisioNize® box enabled

¹⁾ Type A: 130 mm (foam), Type B: 80 mm (foam + VIP), Type C: 130 mm (foam + VIP)²⁾ Optional CO₂/LN₂ backup systems add 8.65 cm/3.5 in to height.³⁾ To allow for handles and hinges, add 80 mm to width of upright freezers and 110 mm to the depth of chest freezers.⁴⁾ Door open adds up to 15 cm.⁵⁾ Empty freezer with shelves fitted, upright freezers only, pull down from 20 – 22 °C ambient conditions.

Get all information about the Eppendorf freezer portfolio!

Explore the eshop and get an overview!

www.eppendorf.link/freezer-portfolio





CryoCube® F570h	CryoCube® F570hw	CryoCube® F570n
vacuum insulation paneling / polyurethane foam	vacuum insulation paneling / polyurethane foam	polyurethane foam
type C	type C	type A
570 L (20.1 ft ³)	570 L (20.1 ft ³)	570 L (20.1 ft ³)
5	5	5
5	5	5
25	25	25
16	16	16
8	8	8
8	8	8
400	400	400
200	200	200
200	200	200
40,000	40,000	40,000
110.3 × 89.8 × 195.0 cm / 43.4 × 35.4 × 76.8 in	110.3 × 89.8 × 195.0 cm / 43.4 × 35.4 × 76.8 in	110.3 × 89.8 × 195.0 cm / 43.4 × 35.4 × 76.8 in
76.5 × 57.5 × 126.5 cm / 30.1 × 22.6 × 49.8 in	76.5 × 57.5 × 126.5 cm / 30.1 × 22.6 × 49.8 in	76.5 × 57.5 × 126.5 cm / 30.1 × 22.6 × 49.8 in
341 kg / 752 lb	341 kg / 752 lb	281 kg / 619 lb
388 kg / 855 lb	388 kg / 855 lb	328 kg / 723 lb
3 h 30 min	3 h 45 min	3 h 50 min
57.7 dBA	56.0 dBA	57.5 dB
230 V, 115 V	230 V	230 V, 208 V, 115 V
7.1 kWh/day		8.8 kWh/day
		8.5 kWh/day
7.4 kWh/day	8.0 kWh/day	8.3 kWh/day
Stainless steel	Stainless steel	Stainless steel
yes	yes	yes
Automatic vent port	Automatic vent port	Automatic vent port
R290 / R170	R290 / R170	R290 / R170
VisioNize® box enabled	VisioNize® box enabled	VisioNize® box enabled

Our Portfolio – Your Choice



Model	Innova® U535	CryoCube® F440h
Insulation	vacuum insulation paneling / polyurethane foam	vacuum insulation paneling / polyurethane foam
Wall Thickness¹⁾	type B	type C
Capacity	535 L (18.9 ft ³)	440 L (15.5 ft ³)
No. of internal doors	3	5
No. of compartments	3	5
Max. racks per freezer	12	20
Box capacity per rack		
53 mm (2 in) tall boxes	28	16
76 mm (3 in) tall boxes	20	8
102 mm (4 in) tall boxes	12	8
Box capacity per freezer		
53 mm (2 in) tall boxes	336	320
76 mm (3 in) tall boxes	240	160
102 mm (4 in) tall boxes	144	160
Sample capacity		
53 mm (2 in) samples	33,600	32,000
Dimensions (W × D × H)²⁾³⁾⁴⁾	80 × 86.7 × 195 cm / 31.5 × 34.1 × 76.8 in	95.5 × 89.8 × 195.0 cm / 37.6 × 35.4 × 76.8 in
Dimensions internal (W × D × H)	64 × 61.5 × 136.5 cm / 25.2 × 24.2 × 53.7 in	61.6 × 57.5 × 126.5 cm / 24.3 × 22.6 × 49.8 in
Weight w/o accessories	250 kg / 551 lb	286 kg / 631 lb
Shipping weight	296 kg / 653 lb	327 kg / 721 lb
Pull-down time to -80 °C⁵⁾	4 h	3 h 20 min
Noise level	56 dBA	51.5 dBA
Power supply	230 V, 208 V, 115 V	230 V, 115 V
Average Daily Consumption (115 V)	13.2 kWh/day	6.5 kWh/day
Average Daily Consumption (208 V)	13.2 kWh/day	
Average Daily Consumption (230 V)	13.2 kWh/day	6.8 kWh/day
Interior (shelves + chamber)	Stainless steel	Stainless steel
Password protection of parameters	yes	yes
Extras	–	Automatic vent port
Cooling liquid	R404A / R508B	R290 / R170
Remote Device Monitoring and Notifications (VisioNize®)	VisioNize® box enabled	VisioNize® box enabled

¹⁾ Type A: 130 mm (foam), Type B: 80 mm (foam + VIP), Type C: 130 mm (foam + VIP)²⁾ Optional CO₂/LN₂ backup systems add 8.65 cm/3.5 in to height.³⁾ To allow for handles and hinges, add 80 mm to width of upright freezers and 110 mm to the depth of chest freezers.⁴⁾ Door open adds up to 15 cm.⁵⁾ Empty freezer with shelves fitted, upright freezers only, pull down from 20 – 22 °C ambient conditions.

Get all information about the Eppendorf freezer portfolio!

Explore the eshop and get an overview!

www.eppendorf.link/freezer-portfolio





New



CryoCube® F440n	CryoCube® F101h	CryoCube® FC660h
polyurethane foam	vacuum insulation paneling / polyurethane foam	vacuum insulation paneling / polyurethane foam
type A	type B	type C
440 L (15.5 ft ³)	101 L (3.6 ft ³)	660 L (23.3 ft ³)
5	2	
5	2	
20	6	40
16	10	13
8	6	9
8	4	7
320	60	520
160	36	360
160	24	280
32,000	6,600	52,000
95.5 × 89.8 × 195.0 cm / 37.6 × 35.4 × 76.8 in	93.6 × 62.9 × 83.4 cm / 36.9 × 24.8 × 32.8 in	207 × 94.5 × 109 cm / 81.5 × 37.2 × 42.9 in
61.6 × 57.5 × 126.5 cm / 24.3 × 22.6 × 49.8 in	48 × 33 × 64 cm / 18.9 × 13 × 25.2 in	147 × 59 × 76 cm / 57.9 × 23.2 × 29.9 in
267 kg / 589 lb	123 kg / 271 lb	304 kg / 670 lb
308 kg / 679 lb	153 kg / 337 lb	379 kg / 836 lb
3 h 35 min	2 h	2 h 50 min
51.5 dBA	39.7 dBA	58.3 dBA
230 V, 208 V, 115 V	230 V, 115 V	230 V, 208 V
8.5 kWh/day	5.1 kWh/day	
7.9 kWh/day		
8.3 kWh/day	4.9 kWh/day	
Stainless steel	Stainless steel	Stainless steel
yes	yes	yes
Automatic vent port	Stackable, fits below bench	30 mm thick inner lids for temp uniformity
R290 / R170	R290 / R170	R290 / R170 (208 V: R404A/ R508B)
VisioNize® box enabled	VisioNize® box enabled	VisioNize® box enabled



CryoCube® F440 Series



Zero compromise

How often do you open your ULT freezer door each day? For how long? What are the crucial factors for maintaining a steady -80 °C? It's best practice to open and close your freezer as quickly as possible when accessing samples. However, locating and removing the correct sample can take time. The more time it takes, the more the temperature of your frozen samples increases as they are exposed to the warm air flow.

The efficient and reliable compressor systems of CryoCube® F440 series ULT freezers ensure sample protection by guaranteeing fast recovery and pull-down back to -80 °C.

The CryoCube® F440h freezer is based on foam insulation enforced by vacuum insulation panels whereas the CryoCube® F440n is based on foam insulation.



For daily usage

- > Space for up to 320 boxes (1.5 mL) for your daily sample storage, combined with efficient pull-down and recovery times back to -80 °C
- > Green cooling (hydrocarbon-based) and low power consumption of 6.8 kWh/ day for high levels of sustainability
- > Technical data based on external test house evaluation for independent validation

Download the
Eppendorf freezer
family brochure



[www.eppendorf.link/
freezer-brochure](http://www.eppendorf.link/freezer-brochure)



Easy opening of your freezer requested? Following the PhysioCare Concept®, the CryoCube® ULT freezers have an ergonomic door handle for convenient opening and closing



Filter cleaning needed for your ULT freezer? Simple filter replacement - just open the filter cover and insert a clean filter



Cleaning your ULT freezer? The inner insulated doors of the CryoCube® freezer can easily be removed to quickly clean and maintain your ULT freezer



Reliable temperature measurement within your ULT freezer requested? All CryoCube® freezers have an integrated probe which is located in the middle compartment for a reliable temperature measurement



Doubled safety for the samples? The built-in temperature probe can be supported by the independent temperature measurement system of VisioNize® sense



Cleaning needed? The CryoCube® F440 ULT freezer is equipped with 5 compartments and a stainless steel chamber for easy cleaning





CryoCube® F740 Series



Design the Freezer Around the Sample

The CryoCube® F740 freezer series is the smartest member of the Eppendorf ULT Freezer family. Combining the high-quality tradition of our previous freezers with an increased capacity, the CryoCube® F740 series is designed to store more of your samples

securely while maintaining optimal energy usage. Fast pull-down and recovery time back to -80°C increase sample safety. The integration of the PhysioCare Concept during development means that the CryoCube® F740 is easier and more comfortable to use, supports an ergonomic workspace, and enables an optimal workflow in the lab.

Smart Control

Worried about the safety of your high value samples stored in your -80 °C ULT freezer? With the Eppendorf ULT monitoring concept available on CryoCube® F740hi/ hiw models, you can check the freezer performance whenever you want. All temperature data and all events are stored in the VisioNize® touch interface.

- > On-board data storage to keep track of freezer data
- > Connect to VisioNize® Lab Suite for 24/7 monitoring and notification (option)
- > Easily adjust parameters using device touchscreen, even while wearing gloves
- > Receive alert notifications to address issues quickly
- > Electronic lock system with user management for controlled access and higher sample safety

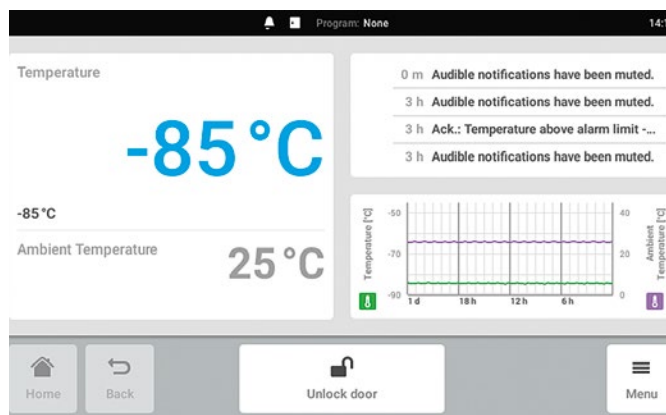

Easy overview required? Quickly review important parameters on the home screen of the ULT freezer

Discover
VisioNize Lab
Suite

www.eppendorf.link/visionize



Subscribe and connect up to three devices for free!



Take your pick: 3-compartment or 5-compartment options available (CryoCube® F740 series only)



If you are in a hurry: Automatic vent port enables fast sample access without door vacuum locking (CryoCube® F440/ 570/ 740 series)



Keep it tight: Compact, flat, and flexible outer door seal for optimal insulation of the CryoCube® ULT freezer

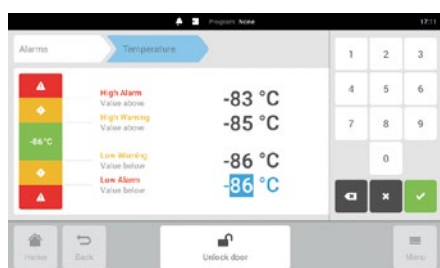

Tailored alarm settings needed? The alarm system of the CryoCube® F740hi freezer can be easily adapted to your needs



Double protection: Gaskets at outer door as well as at inner door (CryoCube® F740 series + Innova® series)



Easy access to filter?: Just flip down the cover of CryoCube® F740 series
Silence requested?: Filter position reduces noise level of CryoCube F740 series



Discover the
Eppendorf freezer
portfolio



[www.eppendorf.link/
freezer-portfolio](http://www.eppendorf.link/freezer-portfolio)





Eppendorf ULT Upright Freezers

Ordering information

Description	Order no.
CryoCube® F740h , 740 L, classic interface, VIP, green cooling liquids, air cooling, handle left side, 3 shelves, 230 V/50 Hz (GB)	F740340012
CryoCube® F740h , 740 L, classic interface, VIP, green cooling liquids, air cooling, handle right side, 3 shelves, 230 V/50 Hz (GB)	F740340022
CryoCube® F740h , 740 L, classic interface, VIP, green cooling liquids, air cooling, handle left side, 5 shelves, 230 V/50 Hz (GB)	F740340032
CryoCube® F740h , 740 L, classic interface, VIP, green cooling liquids, air cooling, handle right side, 5 shelves, 230 V/50 Hz (GB)	F740340042
CryoCube® F740hi , 740 L, touchscreen interface, VIP, green cooling liquids, air cooling, handle left side, 3 shelves, 230 V/50 Hz (GB)	F740320012
CryoCube® F740hi , 740 L, touchscreen interface, VIP, green cooling liquids, air cooling, handle right side, 3 shelves, 230 V/50 Hz (GB)	F740320022
CryoCube® F740hi , 740 L, touchscreen interface, VIP, green cooling liquids, air cooling, handle left side, 5 shelves, 230 V/50 Hz (GB)	F740320032
CryoCube® F740hi , 740 L, touchscreen interface, VIP, green cooling liquids, air cooling, handle right side, 5 shelves, 230 V/50 Hz (GB)	F740320042
CryoCube® F740hiw , 740 L, touchscreen interface, VIP, green cooling liquids, water cooling, handle left side, 3 shelves, 230 V/50 Hz (GB)	F740320112
CryoCube® F740hiw , 740 L, touchscreen interface, VIP, green cooling liquids, water cooling, handle left side, 5 shelves, 230 V/50 Hz (GB)	F740320132
CryoCube® F570n , 570 L, classic interface, green cooling liquids, air cooling, handle left side, 5 shelves, 230 V/50 Hz (EU/GB)	F571300031
CryoCube® F570h , 570 L, classic interface, VIP, green cooling liquids, air cooling, handle left side, 5 shelves, 230 V/50 Hz (EU/GB)	F571340031
CryoCube® F570hw , 570 L, classic interface, VIP, green cooling liquids, water cooling, handle left side, 5 shelves, 230 V/50 Hz (EU/GB)	F571340131
CryoCube® F440h , 440 L, classic interface, VIP, green cooling liquids, air cooling, handle left side, 5 shelves, 230 V/50 Hz (EU/GB)	F440340031
CryoCube® F440n , 440 L, classic interface, green cooling liquids, air cooling, handle left side, 5 shelves, 230 V/50 Hz (EU/GB)	F440300031
Innova® U360 , 360 L, classic interface, classic cooling liquids, air cooling, handle left side, 3 shelves, 230 V/50 Hz (EU/GB)	U9425-0001
CryoCube® F101h , 101 L, classic interface, VIP, green cooling liquids, air cooling, handle right side, 2 shelves, 230 V/50 Hz (GB)	F101340062

New

✂ Ordering information for other voltage options can be found in the “Voltage Version” chapter.

➤ For racks please check page 14

Eppendorf ULT Chest Freezers

Ordering information

Description	Order no.
CryoCube® FC660h , 660 L, classic interface, VIP, green cooling liquids, air cooling, 230 V/50 Hz (EU/GB)	F660320001

✂ Ordering information for other voltage options can be found in the “Voltage Version” chapter.

➤ For racks please check page 14



Freezer Accessories



CO₂ and LN₂ Back-up System

- > Equipped with a battery back-up to temporarily protect the contents of your freezer in case of power or system failure
- > Available in either liquid CO₂ and LN₂. Liquid CO₂ can maintain temperatures between -50 °C and -70 °C, where as LN₂ can go down to -80 °C
- > Both systems can be factory installed with your freezer order or retrofitted on existing models

CO₂ and LN₂ Back-up System for Innova® U101, U360, U535, U725/ -G, C585, C760, CryoCube® F101h and F740 series

Description	Order no.
CO ₂ back-up system, 100 V/50 – 60 Hz (JP)	F652999005
CO ₂ back-up system, 120 – 220 V/60 Hz, Innova® and Green 'G', ('narrow')	U9043-0002
LN ₂ back-up system, 100 V/50 – 60 Hz (JP), Innova® Green 'G' / F740, LN ₂ Backup	F652999006
LN ₂ back-up system, 115 – 220 V/60 Hz, Innova® and Green 'G', ('narrow')	U9044-0002
CO ₂ back-up system, 230 V/50 Hz, Innova®, Green 'G', and CryoCube® 740 series, ('narrow')	U9043-0004
LN ₂ back-up system, 230 V/50 Hz, Innova®, Green 'G', and CryoCube® 740 series, ('narrow')	U9044-0004

CO₂ and LN₂ Back-up Systems for CryoCube® F440/ F570/ FC660 series, Premium U410, HEF® U410

Description	Order no.
CO ₂ back-up system, 120 – 220 V/60 Hz, CryoCube® F440/ F570/ FC660 series, Premium, and HEF®	U9043-0006
LN ₂ back-up system, 120 – 220 V/60 Hz, CryoCube® F440/F570/FC660 series, Premium, and HEF®	U9044-0006
CO ₂ back-up system, 230 V/50 Hz, CryoCube® F440/F570/FC660 series, Premium, and HEF®	U9043-0008
LN ₂ back-up system, 230 V/50 Hz, CryoCube® F440/ F570/FC660 series, Premium, and HEF®	U9044-0008



Chart Recorder

- > Can be factory installed with your freezer order or retrofitted on location
- > Selectable temperature range (0 to -50 °C and -50 to -100 °C) and rotation speed

Ordering information

Description	Order no.
Chart Recorder (Type I)	P0625-2100
Chart Recorder pens (Type I), 3 pcs.	K0660-0051
Chart Recorder paper (Type I), 0 to -50 °C, 60 pcs.	P0625-2111
Chart Recorder paper (Type I), -50 to -100 °C, 60 pcs.	P0625-2110





Freezer Racks

Drawer or side access?

When using racks with drawers, only the drawer with the freezer boxes of interest is pulled out. All other boxes stay in the cold inner area of the ULT freezer. Eppendorf drawers are optimized for smooth movement at -80 °C for ergonomic handling.

When using side access racks, most of the storage boxes have to be pulled out of the cold inner area of the freezer to access the samples. Racks for chest freezers can be equipped with locking rods to secure freezer boxes when pulling out the rack tower.



Stainless steel tower rack for Eppendorf Innova® ULT chest freezers without locking pin: 2.0 in boxes



Rack with locking rod for Eppendorf Innova® ULT chest freezer



Drawer rack for Eppendorf ULT freezer



Side access rack for Eppendorf ULT freezer

Pick your material

Standard freezer racks are available in either stainless steel or aluminum, each with its own benefits.

Stainless steel:

- > Stable/robust for longevity and higher capacity
- > Fits freezer boxes up to 136 mm × 136 mm for high flexibility regarding boxes
- > Special design of drawer racks for optimized cooling conditions and improved sample safety

Aluminum:

- > For freezer boxes up to 133 mm × 133 mm
- > Non-corrosive anodized aluminum for long-term use

3-compartment or 5-compartment?

The freezer with 3 compartments/ shelves (e.g. Innova® U535) has higher compartments compared to the 5-compartment freezer (e.g. CryoCube® F570 series). Racks of a 5-compartment freezer do fit into a 3-compartment freezer but not vice versa. To get the maximum capacity out of your freezer, the CryoCube® F740 series (3-compartment) can be equipped with "3-compartment MAX" racks. These racks only fit into the CryoCube® F740 series 3-compartment instruments.



Stainless steel racks

Ordering information

Description	Order no.
Freezer Rack: Innova® U101, CryoCube® F101h	
2 in/53 mm, drawer, stainless steel	6001062210
2.5 in/64 mm, drawer, stainless steel	6001062910
3 in/76 mm, drawer, stainless steel	6001062310
4 in/102 mm, drawer, stainless steel	6001062410
5 in/127 mm, drawer, stainless steel	6001062510
2 in/53 mm, side access, stainless steel	6001061210
2.5 in/64 mm, side access, stainless steel	6001061910
3 in/76 mm, side access, stainless steel	6001061310
4 in/102 mm, side access, stainless steel	6001061410
5 in/127 mm, side access, stainless steel	6001061510
MAX freezer rack: CryoCube® F101h	
2 in/53 mm, drawer, stainless steel	6001092210
Freezer Rack: CryoCube® F740 series (3-compartment, Standard), Innova® U360, U535	
2 in/53 mm, drawer, stainless steel	6001012210
2.5 in/64 mm, drawer, stainless steel	6001012910
3 in/76 mm, drawer, stainless steel	6001012310
4 in/102 mm, drawer, stainless steel	6001012410
5 in/127 mm, drawer, stainless steel	6001012510
2 in/53 mm, side access, stainless steel	6001011210
2.5 in/64 mm, side access, stainless steel	6001011910
3 in/76 mm, side access, stainless steel	6001011310
4 in/102 mm, side access, stainless steel	6001011410
5 in/127 mm, side access, stainless steel	6001011510
DWP (53 mm), side access, stainless steel	6001011110
Freezer Rack: CryoCube® F440/ F570 series, CryoCube® F740 series (5-compartment, compartment 1-4), Premium U410, HEF® U410	
2 in/53 mm, drawer, stainless steel	6001022210
2.5 in/64 mm, drawer, stainless steel	6001022910
3 in/76 mm, drawer, stainless steel	6001022310
4 in/102 mm, drawer, stainless steel	6001022410
2 in/53 mm, side access, stainless steel	6001021210
2.5 in/64 mm, side access, stainless steel	6001021910
3 in/76 mm, side access, stainless steel	6001021310
4 in/102 mm, side access, stainless steel	6001021410
DWP (53 mm), side access, stainless steel	6001021110
Freezer Rack: CryoCube® F740 series (5-compartment, MAX for 5th comp.)	
2 in/53 mm, side access, stainless steel	6001081210
2.5 in/64 mm, side access, stainless steel	6001081910
3 in/76 mm, side access, stainless steel	6001081310
4 in/102 mm, side access, stainless steel	6001081410
5 in/127 mm, side access, stainless steel	6001081510
DWP (53 mm), side access, stainless steel	6001081110
2 in/53 mm, drawer, stainless steel	6001082210
2.5 in/64 mm, drawer, stainless steel	6001082910
3 in/76 mm, drawer, stainless steel	6001082310
4 in/102 mm, drawer, stainless steel	6001082410
5 in/127 mm, drawer, stainless steel	6001082510

MAX freezer rack: CryoCube® F101h from H2/2023 and newer





Freezer Racks

Please check the rack brochure for easy rack selection or use the rack configuration tool:

Rack configuration

<https://econfig.bio-itech.de/>

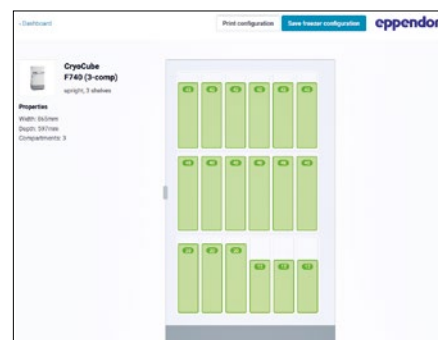

Ordering information

Description	Order no.
Freezer Rack: CryoCube® F740 series (3-compartment, MAX)	
2 in/53 mm, side access, stainless steel	6001071210
2.5 in/64 mm, side access, stainless steel	6001071910
3 in/76 mm, side access, stainless steel	6001071310
4 in/102 mm, side access, stainless steel	6001071410
5 in/127 mm, side access, stainless steel	6001071510
DWP (53 mm), side access, stainless steel	6001071110
2 in/53 mm, drawer, stainless steel	6001072210
2.5 in/64 mm, drawer, stainless steel	6001072910
3 in/76 mm, drawer, stainless steel	6001072310
4 in/102 mm, drawer, stainless steel	6001072410
5 in/127 mm, drawer, stainless steel	6001072510

Freezer Rack: CryoCube® F740 series (3-compartment, Standard)

➤ see page 15 at Innova table

Chest freezer racks

Ordering information

Description	Order no.
Freezer Rack: Innova® C585, C760	
2 in/53 mm, side access, stainless steel	6001040210
Freezer Rack: Innova® C585, C760, CryoCube® FC660 series	
2.5 in/64 mm, side access, stainless steel	6001000910
3 in/76 mm, side access, stainless steel	6001000310
4 in/102 mm, side access, stainless steel	6001000410
5 in/127 mm, side access, stainless steel	6001000510
Freezer Rack: Innova® C585, C760	
DWP (53 mm), side access, stainless steel	6001040110
MTP, side access, stainless steel	6001040010
locking rod, 2 in/53 mm, side access, stainless steel	6001040211
Freezer Rack: Innova® C585, C760, CryoCube® FC660 series	
locking rod, 2.5 in/64 mm, side access, stainless steel	6001000911
locking rod, 3 in/76 mm, side access, stainless steel	6001000311
locking rod, 4 in/102 mm, side access, stainless steel	6001000411
Freezer Rack: Innova® C585, C760	
locking rod, DWP (53 mm), side access, stainless steel	6001040111
locking rod, MTP, side access, stainless steel	6001040011



Ordering information

Description	Order no.
Freezer Rack: CryoCube® FC660 series	
2 in/53 mm, side access, stainless steel	6001050210
Freezer Rack: Innova® C585, C760, CryoCube® FC660 series	
2.5 in/64 mm, side access, stainless steel	6001000910
3 in/76 mm, side access, stainless steel	6001000310
4 in/102 mm, side access, stainless steel	6001000410
5 in/127 mm, side access, stainless steel	6001000510
Freezer Rack: CryoCube® FC660 series	
DWP (53 mm), side access, stainless steel	6001050110
MTP, side access, stainless steel	6001050010
locking rod, 2 in/53 mm, side access, stainless steel	6001050211
Freezer Rack: Innova® C585, C760, CryoCube® FC660 series	
locking rod, 2.5 in/64 mm, side access, stainless steel	6001000911
locking rod, 3 in/76 mm, side access, stainless steel	6001000311
locking rod, 4 in/102 mm, side access, stainless steel	6001000411
Freezer Rack: CryoCube® FC660 series	
locking rod, DWP (53 mm), side access, stainless steel	6001050111
locking rod, MTP, side access, stainless steel	6001050011

Aluminum racks

Ordering information

Description	Order no.
Upright freezer rack: Innova® U101, CryoCube® F101h	
10 boxes per rack, 2 in/53 mm, drawer, aluminum	K0641-3003
6 boxes per rack, 3 in/76 mm, drawer, aluminum	K0641-3004
4 boxes per rack, 4 in/102 mm, drawer, aluminum	K0641-3005
Chest freezer rack: Innova® C585, C760, CryoCube® FC660 series	
13 boxes per rack, 2 in/53 mm, side access, aluminum	K0641-1690
9 boxes per rack, 3 in/76 mm, side access, aluminum	K0641-1700
6 boxes per rack, 4 in/102 mm, side access, aluminum	K0641-1750
Upright freezer rack: CryoCube® F740 series (3-compartment), Innova® U360, U535	
28 boxes per rack, 2 in/53 mm, drawer, aluminum	K0641-3000
20 boxes per rack, 3 in/76 mm, drawer, aluminum	K0641-3001
12 boxes per rack, 4 in/102 mm, drawer, aluminum	K0641-3002
Upright freezer rack: U410 series, CryoCube® F440/ F570 series, CryoCube® F740 series (5-compartment)	
16 boxes per rack, 2 in/53 mm, drawer, aluminum	K0641-1900
12 boxes per rack, 3 in/76 mm, drawer, aluminum	K0641-1890
8 boxes per rack, 4 in/102 mm, drawer, aluminum	K0641-1880

K0641-1890, optimal for cardboard boxes of lower height





Eppendorf Storage Boxes



In need of resilient options for long-term storage?

The Eppendorf Storage Boxes are a durable system solution for sample storage. The outer footprint dimensions (133 mm) are compatible with common freezer rack systems. The different inner grids provide a perfect fit for all typical tube formats: cryogenic tubes, microcentrifuge tubes, conical tubes (5 mL, 15 mL, 25 mL, and 50 mL), and other laboratory vessels. This space-saving approach helps to optimize your storage and archiving of samples.



Product features

- > Made of polypropylene (PP) for high stability in freezing applications and smooth opening and closing
- > For freezing to -86 °C
- > High-contrast permanent alphanumeric marking of each location through laser labeling enables easy sample identification and minimizes risk of sample mix-up

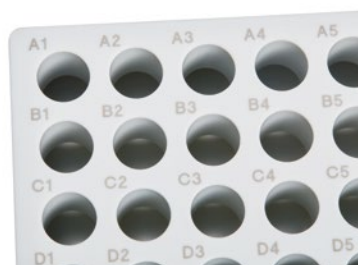

Ordering information

Description	Order no.
Storage Box 10 × 10 , freezer box, for 100 cryogenic tubes w. int. thread, 3 pcs., height 53 mm, 2 in, polypropylene, for freezing to -86 °C, autoclavable, with lid and alphanumeric code	0030140508
Storage Box 9 × 9 , freezer box, for 81 screw cap (cryog.) tubes 1 – 2 mL, 3 pcs., height 53 mm, 2 in, polypropylene, for freezing to -86 °C, autoclavable, with lid and alphanumeric code	0030140516
Storage Box 9 × 9 , freezer box, for 81 screw cap (cryog.) tubes 3 mL, 2 pcs., height 76 mm, 3 in, polypropylene, for freezing to -86 °C, autoclavable, with lid and alphanumeric code	0030140540
Storage Box 9 × 9 , freezer box, for 81 screw cap (cryog.) tubes 4 – 5 mL, 2 pcs., height 102 mm, 4 in, polypropylene, for freezing to -86 °C, autoclavable, with lid and alphanumeric code	0030140567
Storage Box 8 × 8 , freezer box, for 64 tubes 1 – 2 mL, 3 pcs., height 53 mm, 2 in, polypropylene, for freezing to -86 °C, autoclavable, with lid and alphanumeric code	0030140524
Storage Box 5 × 5 , freezer box, for 25 tubes 5 mL, 4 pcs., height 64 mm, 2.5 in, polypropylene, for freezing to -86 °C, autoclavable, with lid and alphanumeric code	0030140532
Storage Box 5 × 5 , freezer box, for 25 tubes 5 mL screw cap, 2 pcs., height 76 mm, 3 in, polypropylene, for freezing to -86 °C, autoclavable, with lid and alphanumeric code	0030140613
Storage Box 5 × 5 , freezer box, for 25 tubes 15 mL, 2 pcs., height 127 mm, 5 in, polypropylene, for freezing to -86 °C, autoclavable, with lid and alphanumeric code	0030140583
Storage Box 3 × 3 , freezer box, for 9 tubes 25 mL, 2 pcs., height 89 mm, 3.5 in, polypropylene, for freezing to -86 °C, autoclavable, with lid and alphanumeric code	0030140729
Storage Box 3 × 3 , freezer box, for 9 tubes 50 mL and 4 tubes 15 mL, 2 pcs., height 127 mm, 5 in, polypropylene, for freezing to -86 °C, autoclavable, with lid and alphanumeric code	0030140591



Eppendorf SafeCode System

Safe sample identification needed?

Missing data are mainly realized during retrospective review. "I should have taken more notes" is probably one of the most frequently uttered phrases in science. Particularly in the case of consumables, all relevant information about the lot/batch, type of product, or purity grade is printed on the outer box. This, together with all the important information about the product, is usually the first to be disposed of, while the tubes with the corresponding samples are stored for years.



The SafeCode system solves these problems: The precoded consumables are pre-labeled with a DataMatrix code and a clear code, encoding one specific kind of serial-number for each individual consumable. This identifier provides far more reliable sample identification than self-generated labels and provides access to the special vessel information mentioned above as well as certificates. These data sets can be downloaded from the Eppendorf website.

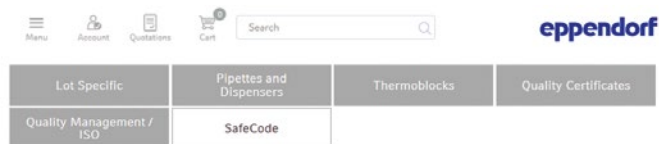

How can I get the ID-specific information for my SafeCode consumables?

Depending on the ID of the Eppendorf SafeCode consumable product, we provide further information like volume, lot numbers, certificates of quality, as well as further documents for your process documentation.

- > Start your process by scanning the SafeCode datamatrix code. Without a dedicated scanner, read the clear coding on the vial
- > Paste the captured code(s) into the box below
- > Receive all ID-specific information and further documents

A package of your dedicated files can be downloaded for documentation purposes.

If you have any further questions you may contact certificates@eppendorf.de



Documentation required?

For certification purposes, more and more users need to document every piece of information. Vessels are a major part of the workflow within the lab. Therefore, further information about Eppendorf consumables with SafeCode are available via the Eppendorf website. Based on the individual vial or tube code you can get:

- > Lot number
- > Order number
- > Certificates

The information can be exported manually into local databases or automatically transferred to the sample management software Eppendorf eLabInventory or eLabJournal® (software add-on).

eLabInventory

Start your 30-day free-trial:

www.elabnext.com/eppendorf



Check the SafeCode system

www.eppendorf.link/SafeCode





Eppendorf CryoStorage Vials



Scanning labels of 20 vials in a row?

The SafeCode system for Eppendorf CryoStorage Vials is based on a 3-level coding to enable safe sample identification. Up to 96 pre-labeled vials are pre-racked and pre-capped for convenient usage.



Product features

- > 3-level coding for safe sample identification
- > ECC 200 error correction function enables safe code reading with up to 25 % damaged codes
- > Temperature range: -196 °C (gas phase of LN₂) to +121 °C

Ordering information

Description	Order no.
Eppendorf CryoStorage Vial , 0.5 mL, free of DNase, RNase, human DNA, endotoxin; external thread, pre-capped gray, with 2D SafeCode (DataMatrix/ECC200), linear and human readable code, 960 vials (10 racks × 96 vials), individually packed racks	0030079400
Eppendorf CryoStorage Vial , 1.0 mL, free of DNase, RNase, human DNA, endotoxin; external thread, pre-capped gray, with 2D SafeCode (DataMatrix/ECC200), linear and human readable code, 960 vials (10 racks × 96 vials), individually packed racks	0030079418
Eppendorf CryoStorage Vial , 1.5 mL, free of DNase, RNase, human DNA, endotoxin; external thread, pre-capped gray, with 2D SafeCode (DataMatrix/ECC200), linear and human readable code, 480 vials (10 racks × 48 vials), individually packed racks	0030079426
Eppendorf CryoStorage Vial , 2.0 mL, free of DNase, RNase, human DNA, endotoxin; external thread, pre-capped gray, with 2D SafeCode (DataMatrix/ECC200), linear and human readable code, 480 vials (10 racks × 48 vials), individually packed racks	0030079434
Eppendorf CryoStorage Vial , 4.0 mL, free of DNase, RNase, human DNA, endotoxin; external thread, pre-capped gray, with 2D SafeCode (DataMatrix/ECC200), linear and human readable code, 480 vials (10 racks × 48 vials), individually packed racks	0030079442
Eppendorf CryoStorage Vial , sterile, 0.5 mL, free of DNase, RNase, human DNA, endotoxin; external thread, pre-capped gray, with 2D SafeCode (DataMatrix/ECC200), linear and human readable code, 960 vials (10 racks × 96 vials), individually packed racks	0030079450
Eppendorf CryoStorage Vial , sterile, 1.0 mL, free of DNase, RNase, human DNA, endotoxin; external thread, pre-capped gray, with 2D SafeCode (DataMatrix/ECC200), linear and human readable code, 960 vials (10 racks × 96 vials), individually packed racks	0030079469
Eppendorf CryoStorage Vial , sterile, 1.5 mL, free of DNase, RNase, human DNA, endotoxin; external thread, pre-capped gray, with 2D SafeCode (DataMatrix/ECC200), linear and human readable code, 480 vials (10 racks × 48 vials), individually packed racks	0030079477
Eppendorf CryoStorage Vial , sterile, 2.0 mL, free of DNase, RNase, human DNA, endotoxin; external thread, pre-capped gray, with 2D SafeCode (DataMatrix/ECC200), linear and human readable code, 480 vials (10 racks × 48 vials), individually packed racks	0030079485
Eppendorf CryoStorage Vial , sterile, 4.0 mL, free of DNase, RNase, human DNA, endotoxin; external thread, pre-capped gray, with 2D SafeCode (DataMatrix/ECC200), linear and human readable code, 480 vials (10 racks × 48 vials), individually packed racks	0030079493



Eppendorf RackScan



Scanning more than one sample at a time?

The Eppendorf RackScan provides you a number of solutions to scan samples tubes with datamatrix (2D) codes. The Eppendorf RackScan b scans data from the bottom of the vessels. The instrument can also be equipped with the „s“ accessory to read side-labeled barcodes.

Data can be exported in different formats for downstream software applications.

Product features

- > Camera based instrument resulting in rapid imaging and decoding
- > Comfortable and easy plug-in system
- > Small footprint, ideal for benchtop (and integration)

Ordering information

Description

Eppendorf RackScan s, code scanner for side reading of SBS racks and cryostorage boxes, accessory for the RackScan product family, /50 – 60 Hz

Order no.

[6002000014](#)

Eppendorf RackScan b, scanner (bottom reading) for 2D-coded tubes in SBS racks and cryostorage boxes, incl. software RackScan Analyzer, 100 – 240 V \pm 10 %/50 – 60 Hz (GB)

[6002000111](#)

✎ Ordering information for other voltage options can be found in the “Voltage Version” chapter.





SafeCode Tubes and Plates

How often do you puzzle about tube labels while working at the bench?

A clean and stable label on the side or top of the vessel can make scientific life so much easier. Eppendorf conical tubes and plates are available with SafeCode - a well-designed barcoding system. Take advantage of the pre-labeled and durable 2-level coding of the SafeCode system (datamatrix code and clear coding) to enable safe sample identification. The plates provide a linear barcode, printed

on 3 sides for highest flexibility. The safe sample ID is supported by online information about the dedicated consumable.

These sets of vessels expand your safe sample management solution from the existing SafeCode CryoStorage Vials at -80 °C storage for complete security in your daily work at the bench.



Product features

- > 2-level coding for safe sample identification
- > ECC 200 error correction function enables safe code reading with up to 25 % damaged codes
- > Temperature range: -86 °C to +121 °C

Safe sample identification needed? Eppendorf SafeCode provides reliable sample IDs for safe identification

New



Documentation for high-throughput applications needed?

Eppendorf SafeCode provides reliable material documentation like certificates via the vessel ID

Documenting every step of your PCR? Eppendorf SafeCode provides a broad range of documents based on the vessel ID



Ordering information

	Description	Order no.
	Eppendorf Conical Tubes , 15 mL, 2D SafeCode, sterile, pyrogen-, DNase-, RNase-, human and bacterial DNA-free, colorless, 500 tubes (10 bags × 50 tubes)	0030113489
	Eppendorf Conical Tubes , 50 mL, 2D SafeCode, sterile, pyrogen-, DNase-, RNase-, human and bacterial DNA-free, colorless, 500 tubes (20 bags × 25 tubes)	0030113497
	Eppendorf Tubes® 5.0 mL , 5 mL, 2D SafeCode, sterile, pyrogen-, DNase-, RNase-, human and bacterial DNA-free, 200 tubes (2 bags × 100 tubes)	0030113500
New	Deepwell Plate 96/500 µL , wells clear, 500 µL, 2D SafeCode, PCR clean, white, 40 plates (5 bags × 8 plates)	0030113543
New	Deepwell Plate 96/1000 µL , wells clear, 1,000 µL, 2D SafeCode, PCR clean, white, 20 plates (5 bags × 4 plates)	0030113535
New	Deepwell Plate 96/2000 µL , wells clear, 2,000 µL, 2D SafeCode, PCR clean, white, 20 plates (5 bags × 4 plates)	0030113527
New	Deepwell Plate 384/200 µL , wells clear, 200 µL, 2D SafeCode, PCR clean, white, 40 plates (5 bags × 8 plates)	0030113551
New	Eppendorf twin.tec® PCR Plate 96 , skirted, wells colorless, 2D SafeCode, PCR clean, colorless, 25 plates	0030113560
New	Eppendorf twin.tec® PCR Plate 384 , skirted, wells colorless, 2D SafeCode, PCR clean, colorless, 25 plates	0030113578
New	Microplate 96/V , wells clear, 2D SafeCode, RecoverMax® well design, PCR clean, white, 80 plates (5 bags × 16 plates)	0030113586



CO₂ Incubators



CO₂ incubators, service products, and digital lab management from Eppendorf



The CO₂ incubator is the home of your cells and a key device in every cell culture lab. Therefore, it is crucial that a CO₂ incubator provides **optimized and stable growth conditions** to ensure a high degree of reproducibility for your culturing results – even for sensitive cells. Fast atmosphere recovery rates after door openings without setpoint overshoot, uniformity of the atmosphere inside the CO₂ incubator chamber, and protection from vibrations and air turbulence are important features to consider and are all parts of the Eppendorf CO₂ incubator lineup. Eppendorf also offers various CO₂ incubator service products like IQ/OQ or preventive maintenance. These services are conducted by experienced Eppendorf service technicians to help you to **continuously achieve reproducible results and prepare for internal or external audits**. Furthermore, **comprehensive and centralized documentation** of incubation conditions (e.g. alerts and events), as well as **management of a device fleet** (e.g. customizable tasks or service reminders) are provided by our VisioNize® Lab Suite for a growing number of devices from Eppendorf.

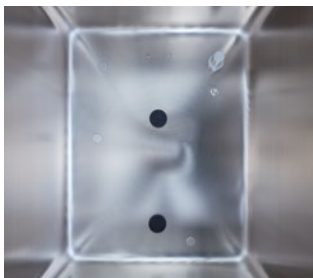

In addition to optimized growth conditions, a CO₂ incubator must provide a **high degree of contamination protection and should be as easy to clean**. Eppendorf CO₂ incubators have a fanless incubator design that leaves no space for contaminants to hide and omits the need for internal fan-associated HEPA-filters. Fast and easy cleaning are ensured by a deep-drawn, seamless incubator chamber, few internal parts that are disassembled and quickly cleaned, and integrated high temperature disinfection (HTD). Furthermore, options for additional protection like copper interior or segmented inner doors are available for selected CO₂ incubators.

Often underestimated, running costs of CO₂ incubators can add significantly to a cell culture lab's total expenses. Main factors include, for example, costs for regular replacement of internal parts like fan-associated HEPA-filters, costs related to gas consumption (incl. gas costs, labor costs for replacing cylinders, CO₂ incubator downtime during changes etc.), costs for lost lab space due to low usable space vs. footprint ratio, or costs for insufficient future flexibility. Eppendorf CO₂ incubators support cell culture labs to **reduce the running costs** and to **achieve corporate carbon footprint reduction goals**.



Get all information about the Eppendorf CO₂ incubator portfolio!

Explore the eshop and get an overview!

www.eppendorf.link/CO2-incubators-portfolio





CO₂ Incubator Service

Qualification, regular maintenance, and calibration of your CO₂ incubator are key to ensure reproducible results and easy audits at any time. Our trained Eppendorf service technicians will help you to continuously achieve this with preventive maintenance, IQ/OQ or extended warranty.



Smart cultivation with VisioNize® Lab Suite

Are you interested in monitoring your lab devices and receiving notifications e.g., for device alerts? A digital, connected lab offers even more.

VisioNize Lab Suite offers everything you need as a lab manager or scientist to get started to digitally manage your lab for increased sample security, compliance needs and maintenance management. Gain access to a modular range of digital services and choose what works for your lab.

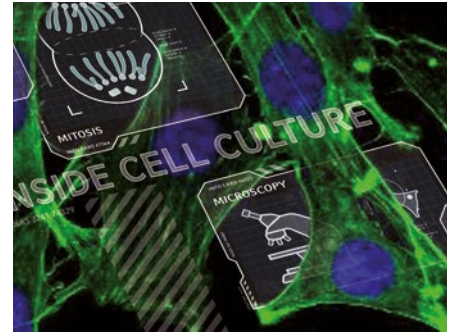

Inside Cell Culture Newsletter

You are experienced in cell culture and want to keep expanding your knowledge? Are you looking for resources to improve your trainings? Then our "Inside Cell Culture" Newsletter is just perfect for you.

- > Tips and tricks to improve your daily work
- > Free videos, downloads, posters and more
- > Access to advanced educational webinars
- > Teaching support resources
- > Upcoming events and trainings

Discover your
service options



[www.eppendorf.link/
epservices](http://www.eppendorf.link/epservices)

Discover VisioNize®
Lab Suite



[www.eppendorf.link/
visionize](http://www.eppendorf.link/visionize)

Sign up now



[www.eppendorf.link/
icc](http://www.eppendorf.link/icc)



Subscribe and connect up to three devices for free!

Our Portfolio – Your Choice



Model	CellXpert® C170i
Positioning	Large (170 L) CO ₂ incubator with many options for demanding cell culture applications (e.g. copper interior or field upgradeable O ₂ control)
Page(s)	6
Capacity	170 L
Dimensions (W × D × H)	71.8 × 71.5 × 90.0 cm / 28.3 × 28.1 × 35.4 in
Dimensions internal (W × D × H)	53.9 × 44.5 × 69.2 cm / 21.2 × 17.5 × 27.2 in
Weight w/o accessories	113 kg / 249 lb
Benchtop (B), Under Bench (U), Floor (F) or Stackable (S)	B, U, F, S (x2)
Display	color touch screen
High temperature disinfection (HTD)	180 °C
Sealed inner glass doors	yes
Segmented door options	4/8 segments (factory & in-field upgradeable)
Temperature range	Ambient +4 °C to 50 °C
Temperature control increment	±0.1 °C
Temperature stability at 37 °C	±0.1 °C
Temperature uniformity	±0.3 °C
Temperature accuracy	±0.3 °C
CO₂ range	0.1 – 20 %
CO₂ control increment	±0.1 %
CO₂ stability at 5 % CO₂	±0.1 %
CO₂ uniformity	±0.1 %
O₂ control	1 – 20 % optional (upgradeable in-field later)
Number of shelves (standard/max)	4/8
Copper options	chamber, water tray, shelves
Access port	2
On-board data logging	yes
Data export interface	USB, Ethernet, VisioNize®
Water/Humidity monitoring	optional
BMS relay	yes
Remote Device Monitoring and Notifications (VisioNize®)	VisioNize® touch enabled

Get all information about the Eppendorf CO₂ incubator portfolio!

Explore the eshop and get an overview!

www.eppendorf.link/CO2-incubators-portfolio



**CellXpert® C170**

Basic version of the C170i

9

170 L

71.8 × 71.5 × 90.0 cm /

28.3 × 28.1 × 35.4 in

53.9 × 44.5 × 69.2 cm /

21.2 × 17.5 × 27.2 in

113 kg / 249 lb

B, U, F, S (x2)

softkey operated LCD display

140 °C

yes

4- (factory-installed)/8-segments (in-field upgrade)

Ambient +4 °C to 50 °C

±0.1 °C

±0.1 °C

±0.3 °C

±0.3 °C

0.1 – 20 %

±0.1 %

±0.1 %

±0.1 %

-

3 (4 with 4-segmented door)/8

water tray, shelves

2

no

Ethernet

-

yes

VisioNize® box enabled

New Brunswick S41iLarge (170 L) CO₂ incubator shaker with integrated high temperature disinfection

10

170 L

87.5 × 73 × 85 cm /

34.4 × 28.7 × 33.5 in

69.1 × 44.4 × 53.8 cm /

27.2 × 17.5 × 21.2 in

154 kg / 340 lb

U, F, S (x2)

touchscreen interface

120 °C

yes

-

Ambient +4 °C to 50 °C

±0.1 °C

±0.1 °C

±0.25 °C at 37 °C (in flask media)

±0.2 °C

0.2 – 20 %

±0.1 %

±0.2 %

±0.1 %

-

1/2

-

1

data display (no data log or export)

Ethernet

-

yes

VisioNize® box enabled



CellXpert® C170i

Description

Cell culture incubator CellXpert® – Culture of Tomorrow

Are you looking for a 170 L cell culture incubator that is easy to clean and delivers optimized growth conditions, even for your sensitive cells? The GMP/GLP-compatible CellXpert C170i is more than just that. It also helps to reduce the running costs of your lab significantly and it provides flexibility for different future lab setups and applications – with many in-field upgradeable options.



Product features

- > **Easy cleaning and disinfection:** Seamless chamber, easy disassembling in 40 s, removable water tray
- > **Certified, effective contamination protection:** 180 °C High temperature disinfection (HTD) with protocol, no internal fan-associated HEPA filters necessary
- > **Uniform temperature:** Innovative heating concept with four temperature sensors at various locations - verified at 27 locations inside the incubator (German DIN 12880:2007-05)

See the Video:
Easy cleaning



[www.eppendorf.link/
Video-Contamination-Prevention](http://www.eppendorf.link/Video-Contamination-Prevention)



Full control and easy documentation with the intuitive user interface.



The removable water tray is easy to clean and refill.

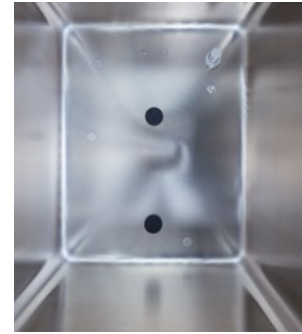

There is no place for contaminants to hide in the seamless chamber.

	C170i	C170
Display	VisioNize® touch interface, onboard data log	Standard display
High temperature disinfection	180 °C standard (protocol downloadable)	140 °C standard
O₂ control (optional)	1-20 % (upgradeable in-field later)	-
In-field upgradeable options	<ul style="list-style-type: none"> > O₂ control > 4/8-segmented inner door > humidity monitoring > water level monitoring > door handle position 	<ul style="list-style-type: none"> > 4/8-segmented inner door > door handle position
Inner door latch	magnetic, dual way	magnetic, single way
VisioNize® Lab Suite	touch enabled	box enabled
VisioNize® device management software including: User management, Performance charts, HTD-wizard, Customized tasks, Remote monitoring, Notifications	standard	optional
USB port	2 (front)	no



White Paper:
Save costs with
the CellXpert



www.eppendorf.link/cut-costs





Ordering information

Segmented door options	Door handle	O ₂ control	Water/Humidity monitoring	Copper package	Order no.
1 segment	right	–	no	no	6731000012
1 segment	right	–	no	yes	6731000512
1 segment	right	–	humidity monitoring	no	6731000112
1 segment	right	–	water-level monitoring	no	6731000212
1 segment	right	–	water and humidity monitoring package	no	6731000312
1 segment	right	1 – 20 %	no	no	6731001012
1 segment	right	1 – 20 %	water and humidity monitoring package	yes	6731001812
1 segment	right	1 – 20 %	no	yes	6731001512
1 segment	left	–	no	no	6731000022
1 segment	left	1 – 20 %	no	yes	6731001522
1 segment	left	–	no	yes	6731000522
1 segment	left	–	humidity monitoring	no	6731000122
1 segment	left	–	water-level monitoring	no	6731000222
1 segment	left	–	water and humidity monitoring package	no	6731000322
1 segment	left	1 – 20 %	no	no	6731001022
1 segment	left	1 – 20 %	water and humidity monitoring package	yes	6731001822
4 segments	right	–	no	no	6731000042
4 segments	right	–	water and humidity monitoring package	no	6731000342
4 segments	right	–	water and humidity monitoring package	yes	6731000842
4 segments	right	1 – 20 %	no	no	6731001042
4 segments	right	1 – 20 %	water and humidity monitoring package	no	6731001342
4 segments	left	–	no	no	6731000052
4 segments	left	–	water and humidity monitoring package	no	6731000352
4 segments	left	–	water and humidity monitoring package	yes	6731000852
4 segments	left	1 – 20 %	water and humidity monitoring package	no	6731001352
4 segments	left	1 – 20 %	no	no	6731001052
8 segments	right	1 – 20 %	no	no	6731001082
8 segments	left	1 – 20 %	no	no	6731001092

✎ Ordering information for other voltage options can be found in the “Voltage Version” chapter.

CellXpert® C170/C170i shelves, water trays and stacking stand

Description	Order no.
Door lock, for CellXpert® C170i CO ₂ incubators, retrofittable, no service required	6731070166
Stacking stand, lower frame, with castors	6731070093
Stacking stand, upper frame	6731070085
Universal stacking stand, upper frame, CellXpert with other 170 L CO ₂ incubators	6731070158
Safety fastening kit	6710070235
Set of copper water tray and 4 copper shelves for 170 L incubators	6731080013
Copper water tray, for 170 L incubators	P0628-6260
Copper shelves, for 170 L incubators, 2 pcs.	6710859106
Shelves, for 170 L incubators, 2 pcs.	6710859009
Shelf, for 170 L CO ₂ incubators, stainless steel, 1 piece	6731070123
Shelf rack for 8 shelves, for 170 L incubators	P0628-6390
Water tray, for 170 L incubators	P0628-6140
Door damper kit for CellXpert®	6731070115



CellXpert® C170

Description

The C170 is the basic version of the C170i. It comes with the same uniform atmosphere, fast recovery, cleanability, high usable space but for example with a simpler user interface and less in-field upgradeable options. Use the flyer "C170i vs. C170" to find the right device for your needs.



The CellXpert C170i and C170 are stackable with CO₂ incubators of Thermo Scientific®, PHCbi (former Panasonic) and more with the Universal Stacking Kit

Product features

- > **Easy cleaning and disinfection:** Seamless chamber, easy disassembling in 40 s, removable water tray
- > **Effective contamination protection:** 140 °C High temperature disinfection (HTD), no internal fan-associated HEPA-filters necessary
- > **Uniform temperature:** Innovative heating concept with four temperature sensors at various locations - verified at 27 locations inside the incubator (German DIN 12880:2007-05)

C170i or C170?
Find the right
CellXpert for your
needs.



[www.eppendorf.link/
C170i-C170](http://www.eppendorf.link/C170i-C170)

Ordering information

Description

CellXpert® C170, non-segmented inner door, handle right side, 220 – 240 V/50 – 60 Hz (GB)

CellXpert® C170, inner door with 4 door segments, handle right side, 220 – 240 V/50 – 60 Hz (GB)

Order no.

[673400012](#)

[673400042](#)

✎ Ordering information for other voltage options can be found in the "Voltage Version" chapter.

[For Accessories see page 11](#)





New Brunswick S41i

Description

Are you looking for a CO₂ incubator shaker with integrated high temperature disinfection (120 °C) and significantly reduced gas consumption? Make cleaning easy and change CO₂ cylinders less often with the fanless and stackable New Brunswick S41i.



Product features

- > Experimental flexibility: Perforated shelf allows for static incubation at the same time as shaking
- > Stable, uniform and vibration-free shaking: robust Innova triple eccentric drive
- > Saves gas and provides an optimal growing atmosphere: Smart gas control (0.2 - 20% CO₂)

Applications

- > Culturing of suspension cells requiring gentle agitation
- > Protein expression
- > Adherent cells such as stem cells that require both incubation and periodic gentle shaking

Download flyer

Incubator Shaker Evolution

[www.eppendorf.link/
flyer-incubator-shaker-evolution](http://www.eppendorf.link/flyer-incubator-shaker-evolution)



Ordering information

Description	Order no.
New Brunswick S41i , 170 L, CO ₂ incubator shaker with inner shelf and touch screen control, stackable up to 2-fold, 1 (2. optional) shelves, 230 V/50/60 Hz (GB), orbit 2.5 cm (1 in), UK	S41I230012
Universal platform for New Brunswick S41i , 36 × 61 cm (14 × 24 in), compatible with sticky pads: 5 necessary to cover platform (sold separately, order no: M1250-9700, cutting required), anodized aluminum	M1334-9920
Interchangeable platform for New Brunswick S41i , 36 × 61 cm (14 × 24 in)	
125 mL Erlenmeyer flask dedicated platform, comes complete with 32 clamps installed	M1334-9921
250 mL Erlenmeyer flask dedicated platform, comes complete with 24 clamps installed	M1334-9922
500 mL Erlenmeyer flask dedicated platform, comes complete with 15 clamps installed	M1334-9923
1 L Erlenmeyer flask dedicated platform, comes complete with 11 clamps installed	M1334-9924
2 L Erlenmeyer flask dedicated platform, comes complete with 6 clamps installed	M1334-9925
Stacking kit , allows up to 2 each New Brunswick S41i shakers to be stacked one on top of the other	P0628-6502
Additional shelf for New Brunswick S41i , perforated, can easily be added for static cell culture of adherent cells	P0628-6181
Sticky pad , 20 × 20 cm (8 × 8 in), Compatible platform or adapter kit necessary	M1250-9700

✎ Ordering information for other voltage options can be found in the “Voltage Version” chapter.



Additional CO₂ Incubators Accessories



For stacking kits see individual CO₂ incubator pages.

White paper:
Guide to copper in
CO₂ incubators



[www.eppendorf.link/
copper-CO2-incubators](http://www.eppendorf.link/copper-CO2-incubators)

Ordering information

Description	Order no.
HEPA filter 25 mm	P0628-5060
In-line gas filter, 2 pcs.	6710070251
Automatic gas cylinder CO ₂ changeover unit	P0628-5000
Temperature probe, 100 mm tip for gas analyzer	P0628-7880
Temperature probe, 5 mm tip for gas analyzer	P0628-7881
Gas tubing, 3 m, with in-line gas filter	6731070107



Lab Shakers



Incubated lab shakers

If the growth atmosphere needs to be controlled (e.g. temperature and photosynthetic light) and medium or high throughput is needed, an incubated lab shaker is necessary. Usually, incubated lab shakers are grouped based on any of the following criteria:

Temperature control:

- > Cooling for a minimum of 4 °C
- > Heating for a maximum of 80 °C

- > Speed range (25 – 500 rpm)
- > Position in the lab (Benchtop, under bench or stackable floor models)
- > Stackability (2- or 3-fold)
- > Capacity and throughput: Vessel type, size and capacity
- > Mode of loading (front vs. top loading)
- > CO₂ control
- > Photosynthetic light

Lab Shaker Service

Qualification, regular maintenance, and calibration of your lab shaker are key to ensure reproducible results and easy audits at any time. Our trained Eppendorf service technicians will help you to continuously achieve this with preventive maintenance, IQ/OQ or extended warranty.

Smart shaking with VisioNize® Lab Suite

Are you interested in monitoring your lab shakers and other devices? What about receiving notifications e.g., for device alerts? A digital, connected lab offers even more.

VisioNize Lab Suite offers everything you need as a lab manager or scientist to get started to digitally manage your lab for increased sample security, compliance needs and maintenance management. Gain access to a modular range of digital services and choose what works for your lab.



Discover your service options
www.eppendorf.link/epservices



Discover VisioNize® Lab Suite
www.eppendorf.link/visionize

Lab Shaker Accessories

Eppendorf offers a wide range of accessories for lab shakers to provide full flexibility for your processes.

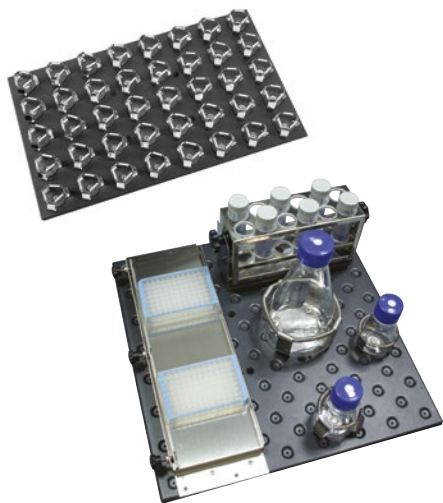

Lab shaker platforms

Different lab shaker platforms are available to provide you with the right balance between vessel capacity, vessel type flexibility, handling speed, and regarding necessary shaking speeds:

- > Dedicated platforms
- > Universal platforms
- > Sticky pad platforms

Universal platforms are the best choice when a high degree of vessel type flexibility is needed, e.g. to mix different vessel types and sizes. These platforms come with multiple screwing holes that allow virtually any

combination of lab shaker clamps and other accessories. Dedicated platforms are used when just one flask size will be used and high capacity is needed. Dedicated platforms come complete with clamps installed. Adhesive mats called sticky pad can be used as an alternative to clamps for flat bottom vessels. Sticky pads are re-usable and require an anodized aluminum platform for best performance. Thus, sticky pads are compatible with universal platforms of New Brunswick S41i and Innova® S44i. All other shakers require a sticky pad adapter kit for universal platforms or a dedicated sticky pad platform.



Flask clamps for lab shakers

Eppendorf flask clamps for lab shakers are made of a single piece stainless-steel construction (not spot welded or riveted) for added strength and safety. All flask clamps come with coiled wire springs for added safety and stability at higher shaking speeds. Flasks clamps for 2-, 2.8-, 4- and 6 L and higher volumes come with an extra girdle for added security and noise reduction.

Available clamps for lab shakers:

- > Erlenmeyer flask clamps (10 mL – 6 L)
- > 2.8 L Fernbach flask clamps
- > 500 mL and 1 L media bottles
- > 450 mL or 600 mL TPP bioreactors
- > 2 L Lauber Thomson flask clamps



Test tube racks and microplate racks for lab shakers

Eppendorf offers 18 different racks for various test tubes with diameters between 8 – 30 mm. Racks come with an adjustable angle (to optimize media oxygenation), tube height-support, and are made of stainless-steel with specialized inserts. These inserts help to retain tubes and prevent them from spinning in the shaker rack.

Two different racks for microplates are available: for stacks (three deep-well plates or nine standard plates) or single layers (five plates). In addition, universal lab shaker platforms are also compatible with microplate screening systems like the Duetz System.



Our Portfolio – Your Choice



Model	Innova® S44i	Innova® 44/44R	Innova® 43/43R
Page(s)	6	8	9
Positioning	Most advanced stackable (2-3x) incubator shaker with highest capacity in our portfolio	Stackable (2-3x) incubator shaker with high vessel capacity	Top-loading incubator shaker with large capacity for easy handling flasks with volume up to 6 L
Capacity	extra large	large	large
Platform size (cm/in)	76 × 62 cm (30 × 24 in)	76 × 46 cm (30 × 18 in)	76 × 46 cm (30 × 18 in)
Max. vessel volume (without static shelf, depending on flask format)	5 L	5 L	6 L
Application-related features			
Bacteria, Yeast, Fungi, Insect cells	yes	yes	yes
Algae/plant cells	yes (LED-light, tunable intensity to simulate day/night-cycles)	yes (fluorescent bulbs, no intensity modulation)	yes (fluorescent bulbs, no intensity modulation)
Mammalian cells (CO ₂ control and humidification)	no	no	no
Parallel static cultivation	yes (static shelves optional)	no	no
Orbit	2.5/5.1 cm (1/2 in)	2.5/5.1 cm (1/2 in)	2.5/5.1 cm (1/2 in)
Temperature range	Incubated: 10 °C above ambient to 80 °C; Refrigerated: 15 °C below ambient (min. 4 °C) to 80 °C.	Incubated: 10 °C above ambient to 80 °C; Refrigerated: 20 °C below ambient (min. 4 °C) to 80 °C (max. 70 °C with PS-light, 60 °C with rH-monitoring).	Incubated: 10 °C above ambient to 80 °C; Refrigerated: 20 °C below ambient (min. 4 °C) to 80 °C (max. 70 °C with PS-light, 60 °C with rH-monitoring).
Speed range	2.5 cm orbit: 20 – 400 rpm, 5.1 cm orbit: 20 – 300 rpm	25 – 400 rpm with 2.5 cm orbit; 25 – 300 rpm with 5.1 cm orbit or 2 stacked units; 25 – 250 rpm with 3 stacked units	25 – 500 rpm with 2.5 cm orbit; 25 – 300 rpm with 5.1 cm orbit
Lab position and stackability			
Lab position	floor	floor	floor (console-style)
Stackability	up to 3-fold	up to 3-fold	non-stackable
Handling, ergonomics, programmability			
Door opening	glide up	glide up	console style
Platform type	slide out	slide out	fixed
Programming steps / storable programs	unlimited/unlimited	15/4	15/4
Drive mechanism	Eppendorf X-Drive	triple-eccentric counterbalanced drive	triple-eccentric counterbalanced drive
Dimensions (W × D × H)	118.2 × 86.9 × 63 cm / 46.5 × 34.2 × 24.8 in	134.9 × 84.3 × 66 cm / 53.1 × 33.2 × 26 in	115.6 × 81.3 × 103.1 cm / 45.5 × 20 × 40.6 in

Get all information about the Eppendorf lab shaker portfolio!

Explore the eshop and get an overview!

www.eppendorf.link/shakers-portfolio





Innova® 42/42R 10	Innova® 40/40R 12	New Brunswick S41i CO ₂ Incubators page 10
Space-saving, stackable (2x) incubator shaker with high versatility	Benchtop orbital shaker with compact design and capacity for flasks with a volume up to 3 L	Large (170 L) CO ₂ incubator shaker with integrated high temperature disinfection
medium	medium	medium
46 x 46 cm (18 x 18 in)	46 x 46 cm (18 x 18 in)	36 x 61 cm (14 x 24 in)
6 L	3 L	4 L
yes	yes	no
yes (fluorescent bulbs, no intensity modulation)	no	no
no	no	yes
yes (one static shelf included, culture drawer for Agar plates optional)	no	yes (static shelf included)
1.9/2.5 cm (0.75/1 in)	1.9/2.5 cm (0.75/1 in)	2.5 cm (1 in)
Incubated: 10 °C above ambient to 80 °C; Refrigerated: 20 °C below ambient (min. 4 °C) to 80 °C (max. 70 °C with PS-light, 60 °C with rH-monitoring).	Incubated: 10 °C above ambient to 80 °C; Refrigerated: 15 °C below ambient (min. 4 °C) to 80 °C.	Ambient +4 °C to 50 °C
25 – 400 rpm; 25 – 300 rpm when using flasks > 500 mL in stacked devices	25 up to 500 rpm (depending on load)	25 – 400 rpm (25 – 250 rpm for bottom unit if stacked)
floor, under/on bench up to 2-fold	benchtop non-stackable	floor, under bench up to 2-fold
opening to front fixed 15/4	top opening hood fixed 15/4	opening to front fixed –
triple-eccentric counterbalanced drive	triple-eccentric counterbalanced drive	triple-eccentric counterbalanced drive
63.5 x 74.5 x 81.8 cm / 25 x 29.3 x 32.8 in	55.9 x 76.2 x 61 cm / 22 x 30 x 24 in	87.5 x 73 x 85 cm / 34.4 x 28.7 x 33.5 in



Innova[®] S44i



Description

Do you need a stackable incubator shaker for the highest plasmid or protein yields in a small footprint to quickly reach your ambitious targets? The latest and most advanced incubator shaker from Eppendorf, the Innova S44i, can fit up to twice as many flasks as other shakers in the market and is ready to reliably support current high-yield expression protocols at high speeds, 24/7.

Product features

- > **For higher plasmid or protein quantities:** Up to twice as many flasks as other shakers (e.g. 15x/13x 2.5 L UltraYield™ or 39/36x 1 L Erlenmeyer flasks on dedicated/universal platform); 2x/3x stackable
- > **Ready for high-speed expression protocols:** Up to 400 rpm (orbit 25 mm/1 in) in all devices of a triple stack
- > **True control with touch interface:** All setpoints and current values are visible at a glance; Restrict access to change settings with user management

Applications

- > Grow bacteria, yeast, fungus, photosynthetic organisms
- > Plasmid DNA production and protein expression
- > Process optimization and media development
- > Media screening and optimization
- > Seed cultures for bioprocess scale-up
- > Biofuel research
- > Food quality testing



Subscribe and connect up to three devices for free!

See the video:
Innova[®] S44i
fully loaded



www.eppendorf.link/s44i-fully-loaded



Eppendorf X-Drive: The five eccentric mounting points for the shaker platform are precisely engineered to ensure long-lasting, repeatable performance for years to come. The four shafts in the corners and Balance Master Technology support precise vibration-free shaking on every point of the platform, including the periphery.



Glide up door: saves lab space and makes cleaning easier



All parameter at a glance



The Innova S44i is also available with a photosynthetic LED light bank for the growth of algae or plant cells.

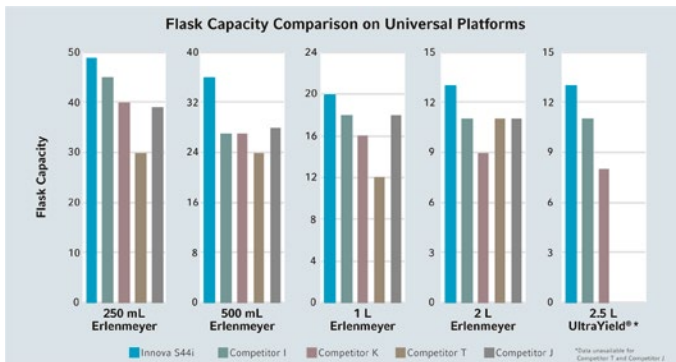

Compare your Innova® S44i now



www.eppendorf.link/s44i-comparison

Ordering information

Description

Innova® S44i, non-refrigerated, stackable up to 3-fold, 230 V/50/60 Hz (GB), orbit 2.5 cm (1 in)

Innova® S44i, refrigerated, stackable up to 3-fold, 230 V/50/60 Hz (GB), orbit 2.5 cm (1 in)

Innova® S44i, refrigerated, stackable up to 3-fold, 230 V/50/60 Hz (GB), orbit 2.5 cm (1 in), photosynthetic LED light bank

Innova® S44i, non-refrigerated, stackable up to 3-fold, 230 V/50/60 Hz (GB), orbit 5.1 cm (2 in)

Innova® S44i, refrigerated, stackable up to 3-fold, 230 V/50/60 Hz (GB), orbit 5.1 cm (2 in)

Innova® S44i, refrigerated, stackable up to 3-fold, 230 V/50/60 Hz (GB), orbit 5.1 cm (2 in), photosynthetic LED light bank

Positioning base (small), 10.16 cm (4 in), Innova® S44i

Positioning base (tall), 30.48 cm (12 in), Innova® S44i

Stacking kit, for double stack of Innova® S44i

Stacking kit, for Innova® S44i to Innova® 44/44R

Stacking kit, for triple stack Innova® S44i

Static incubation shelf, Innova® S44i

Darkening window shade, removable, Innova® S44i

Universal platform for Innova® S44i, 76 × 62 cm (30 × 24 in), compatible with sticky pads: 9 necessary to cover platform (sold separately, order no: M1250-9700, cutting required), anodized aluminum

125 mL Erlenmeyer flask dedicated platform, 86 clamps

250 mL Erlenmeyer flask dedicated platform, 53 clamps

500 mL Erlenmeyer flask dedicated platform, 39 clamps

2 L Lauber Thomson flask dedicated platform, 15 clamps, aluminum, for 2 L narrow neck Erlenmeyer, Thomson, or Corning flasks (DIN-ISO 1773) bottom diameter ~166 mm

1 L Erlenmeyer flask dedicated platform, 23 clamps

2 L Erlenmeyer flask dedicated platform, 15 clamps, aluminum, for 2 L wide neck Erlenmeyer flasks (DIN-ISO 24450), bottom diameter ~153 mm

Order no.

[S44I300002](#)

[S44I310002](#)

[S44I311002](#)

[S44I320002](#)

[S44I330002](#)

[S44I331002](#)

[S44I041001](#)

[S44I041002](#)

[S44I041005](#)

[S44I041006](#)

[S44I041003](#)

[S44I042001](#)

[S44I042002](#)

[S44I040001](#)

[S44I040002](#)

[S44I040003](#)

[S44I040004](#)

[S44I040010](#)

[S44I040005](#)

[S44I040006](#)

✎ Ordering information for other voltage options can be found in the “Voltage Version” chapter.



Your local distributor: www.eppendorf.link/contact

Eppendorf UK Limited · Gateway 1000 · Whittle Way · Stevenage SG1 2FP · United Kingdom · sales@eppendorf.co.uk · www.eppendorf.com · www.eppendorf.link/eshop



New Brunswick Innova® 44/44R



Description

Are you looking for a reliable high-capacity stackable incubator shaker? The Innova 44/44R is one of our most popular shakers – its capacity for flasks up to 5 L in volume, the space-saving glide up door, multistep programming, the reliable Innova triple-eccentric drive, and the cost saving potential make it a smart choice.

Product features

- > **Applicational flexibility:** Accommodates flasks up to 5 L, sticky pad platform for flat bottom vessels, orbits 25 or 51 mm (1 or 2 in), optional: photosynthetic light bank and humidity monitoring
- > **Saves money and lab space:** No internal HEPA-filter that must be replaced annually for optimal performance, 2x/3x stackable in a small footprint
- > **Reliable 24/7 with high loads:** Innova triple eccentric counterbalanced drive (three weight-supporting shafts; please do not confuse with “triple counterbalanced” drives that usually come with only one weight support), max. load 26 kg / 57 lb (solid weight test)

Ordering information

Description	Order no.
New Brunswick Innova® 44	
stackable up to 3-fold, 230 V/50/60 Hz (EU/CN), orbit 2.5 cm (1 in)	M1282-0002
stackable up to 3-fold, 230 V/50/60 Hz (EU/CN), orbit 5.1 cm (2 in)	M1282-0012
New Brunswick Innova® 44R	
refrigerated, stackable up to 3-fold, 230 V/50/60 Hz (EU/CN), orbit 2.5 cm (1 in)	M1282-0006
refrigerated, stackable up to 3-fold, 230 V/50/60 Hz (EU/CN), orbit 5.1 cm (2 in)	M1282-0016
Stacking kit , for stacking one additional 44 or 44R (3 × Innova® 44/44R can be placed in a single stack)	M1282-0500
Remote alarm option , for Innova® 44/44, Innova® 43/43, Innova® 42/42 or Innova® 40/40	M1320-8029
Universal platform for Innova® 44/44R , 76 × 46 cm (30 × 18 in), not interchangeable with other 76 × 46 cm platforms	M1282-9904
Aluminum platform for Innova® 44/44R , 76 × 46 cm (30 × 18 in), not interchangeable with other 76 × 46 cm platforms	
125 mL Erlenmeyer flask dedicated platform	M1282-9905
250 mL Erlenmeyer flask dedicated platform	M1282-9906
500 mL Erlenmeyer flask dedicated platform	M1282-9907
1 L Erlenmeyer flask dedicated platform	M1282-9908
2 L Erlenmeyer flask dedicated platform for Innova® 44 , 76 × 46 cm (30 × 18 in), 12 clamps, aluminum, for 2 L wide neck Erlenmeyer flasks (DIN-ISO 24450), bottom diameter ~153 mm. For 2 L narrow neck Erlenmeyer, Thomson, or Corning flasks (DIN-ISO 1773) bottom diameter ~166 mm, please refer to universal platform and clamps M1190-9004	M1282-9909
Sticky pad platform for Innova® 44(R) , 76 × 46 cm (30 × 18 in), 7 sticky pads necessary to cover platform (sold separately, order no: M1250-9700, cutting required), anodized aluminum	M1282-9913
Heavy duty 0.95 cm-thick aluminum plate platform for Innova® 44/44R only , 76 × 46 cm (30 × 18 in), not interchangeable with other 76 × 46 cm platforms. Heavy-duty platforms are recommended for shaking full loads of flasks, 1 L and larger, containing more than 20 % volume or with baffles.	
Heavy duty universal platform	M1282-9915
1 L Erlenmeyer flask dedicated platform, heavy duty	M1282-9925
2 L Erlenmeyer flask dedicated platform, heavy duty, for 2 L wide neck Erlenmeyer flasks (DIN-ISO 24450)	M1282-9926
Positioning bases , increases the height of the shaker for easier access, mandatory for stacked shakers	
for Innova® 44/44R, 10.2 cm, short	M1282-0600
for Innova® 44/44R, 30.5 cm, medium	M1282-0800
for Innova® 44/44R, 40.6 cm, tall	M1282-0700
12-port gassing manifold , for Innova® 44R - contact Eppendorf for installation options	M1282-0291
Humidity monitor , for Innova® 44R - contact Eppendorf for installation options	M1282-5011
UV germicidal light , for Innova® 44R - contact Eppendorf for installation options	M1282-9921
Photosynthetic light bank , for Innova® 44R - contact Eppendorf for installation options	M1282-9922

✎ Ordering information for other voltage options can be found in the “Voltage Version” chapter.



New Brunswick Innova® 43/43R



Description

Are you looking for a large-capacity console incubator shaker for easy handling of large shake flasks? Have a look at the Innova 43 which offers peace of mind 24/7 with the famous heavy-duty Innova triple eccentric drive. It also reduces running costs significantly as there is no internal HEPA-filter that requires yearly replacement for optimal performance.

Product features

- > **Applicational flexibility:** Accommodates flasks up to 6 L, sticky pad platform for flat bottom vessels, orbits 25 or 51 mm (1 or 2 in), optional: photosynthetic light bank and humidity monitoring
- > **Saves money:** No internal HEPA-filter that must be replaced annually for optimal performance
- > **Reliable 24/7 with high loads:** Proven and tested Innova triple eccentric counterbalanced drive (three weight-supporting shafts)

Ordering information

Description	Order no.
New Brunswick Innova® 43	
non-stackable, 230 V/50/60 Hz (CN/EU), orbit 2.5 cm (1 in)	M1320-0002
non-stackable, 230 V/50/60 Hz (CN/EU), orbit 5.1 cm (2 in)	M1320-0012
New Brunswick Innova® 43R	
refrigerated, non-stackable, 230 V/50/60 Hz (CN/EU), orbit 2.5 cm (1 in)	M1320-0006
refrigerated, non-stackable, 230 V/50/60 Hz (CN/EU), orbit 5.1 cm (2 in)	M1320-0016
Remote alarm option , for Innova® 44/44, Innova® 43/43, Innova® 42/42 or Innova® 40/40	M1320-8029
Platforms for Innova® 2300/43/43R, Excella® E10/E25/E25R , 76 × 46 cm (30 × 18 in), aluminum, Universal platform	M1250-9920
Platform for Innova® 2300/43/43R, Excella® E10/E25/E25R , 76 × 46 cm (30 × 18 in), aluminum	
125 mL Erlenmeyer flask dedicated platform	M1191-9909
250 mL Erlenmeyer flask dedicated platform	M1191-9910
500 mL Erlenmeyer flask dedicated platform	M1191-9911
1 L Erlenmeyer flask dedicated platform	AG-1
2 L Erlenmeyer flask dedicated platform, for 2 L wide neck Erlenmeyer flasks (DIN-ISO 24450), bottom diameter ~153 mm. For 2 L narrow neck Erlenmeyer, Thomson, or Corning flasks (DIN-ISO 1773) bottom diameter ~166 mm please refer to universal platform and clamps M1190-9004.	AG-2
Sticky pad platform for Innova® 43(R)/2300 , 76 × 46 cm (30 × 18 in), 7 sticky pads necessary to cover platform (sold separately, order no: M1250-9700, cutting required), anodized aluminum	M1250-9904
Utility tray with non-skid rubber surface for Innova® 2300 , usable as a stand-alone – no other platform required	AG-00
12-port gassing manifold , permits direct gassing into flasks	M1320-0500
Humidity monitor , for use with spill pan as water reservoir, for Innova® 43/43R	M1320-0600
UV germicidal light , in the airflow path outside the chamber reduces the bio-burden of circulated air, Innova® 43R only	M1320-0400
Photosynthetic light bank , for Innova® 43R only	M1320-0300

✎ Ordering information for other voltage options can be found in the “Voltage Version” chapter.





New Brunswick Innova® 42/42R



Description

Are you looking for a highly-versatile stackable incubator shaker that comes with Innova reliability? The Innova 42/42R is one of our most popular shakers because of its cleanability, variety of options (like a static cultivation shelf, a culture drawer to protect Agar plates from evaporation, UV germicidal or photosynthetic light), and flexibility of positioning in the lab.

Product features

- > **High capacity in a small footprint:** for example, 4x 5 L or 2x 6 L flasks on universal platform; device footprint 4731 cm² /733 in² (63.5 cm/25 in width, 74.5 cm/29.3 in depth)
- > **Ergonomical and safe interface handling:** Top mounted controls and display make bending down unnecessary during handling, avoids accidental parameter changes, and can be reached easily even in a double stack
- > **Easy to clean:** Spill diverter and drainable built-in spill pan with rounded corners protect the drive from accidental spills (can be used as a water reservoir to reduce sample evaporation); airflow UV-germicidal light optional

More info about the
Innova 42/42R
Download Flyer



[www.eppendorf.link/
flyer-Innova-42-42R](http://www.eppendorf.link/flyer-Innova-42-42R)



Ordering information

Description	Order no.
New Brunswick Innova® 42 , small stackable shaker	
stackable up to 2-fold, 230 V/50/60 Hz (CN/EU), orbit 1.9 cm (0.75 in), one height-adjustable shelf (stainless steel) included, additional shelves can be added (Order no. M1335-0080)	M1335-0002
stackable up to 2-fold, 230 V/50/60 Hz (CN/EU), orbit 2.5 cm (1 in), one height-adjustable shelf (stainless steel) included, additional shelves can be added (Order no. M1335-0080)	M1335-0012
New Brunswick Innova® 42R , small stackable shaker	
refrigerated, stackable up to 2-fold, 230 V/50/60 Hz (CN/EU), orbit 1.9 cm (0.75 in), one height-adjustable shelf (stainless steel) included, additional shelves can be added (Order no. M1335-0080)	M1335-0006
refrigerated, stackable up to 2-fold, 230 V/50/60 Hz (CN/EU), orbit 2.5 cm (1 in), one height-adjustable shelf (stainless steel) included, additional shelves can be added (Order no. M1335-0080)	M1335-0016
Stacking kit , for stacking Innova® 42/42R units	M1335-0800
Stacking kit , for stacking Innova® 4200/4230 units on top of Innova® 42/42R shakers	M1335-0810
Remote alarm option , for Innova® 44/44, Innova® 43/43, Innova® 42/42 or Innova® 40/40	M1320-8029
Additional perforated shelf and brackets , for Innova® 42/42R	
stainless steel, 19.5 x 19.5 in / 49.5 x 49.5 cm (W x D)	M1335-0080
Platforms for Innova® 2100/40/40R/42/42R, Excella® E24/E24R , 46 x 46 cm (18 x 18 in), phenolic resin (unless otherwise stated)	
Universal platform, aluminum	M1250-9902
125 mL Erlenmeyer flask dedicated platform	M1194-9904
250 mL Erlenmeyer flask dedicated platform	M1194-9905
500 mL Erlenmeyer flask dedicated platform	M1194-9906
1 L Erlenmeyer flask dedicated platform	M1194-9907
2 L Erlenmeyer flask dedicated platform, for 2 L wide neck Erlenmeyer flasks (DIN-ISO 24450), bottom diameter ~153 mm. For 2 L narrow neck Erlenmeyer, Thomson, or Corning flasks (DIN-ISO 1773) bottom diameter ~166 mm refer to universal platform and clamps M1190-9004.	M1194-9908
Sticky pad platform for Innova® 40(R)/42(R)/2100, Excella® E24(R) , 46 x 46 cm (18 x 18 in), 4 sticky pads necessary to cover platform (sold separately, order no: M1250-9700), anodized aluminum	M1250-9903
Sticky pad adapter kit , 2 anodized aluminum sheets, each 15.2 x 45.7 cm (6 x 18 in)	M1250-9504
Sticky pad , 20 x 20 cm (8 x 8 in), Compatible platform or adapter kit necessary	M1250-9700
Quick-change platform kit , enables platform attachment without tools, for Innova® 2100/4000/4080/4230	M1192-9901
Culture drawer , (height adjustable) prevents plates from drying	M1335-0501
Utility carrier , holds racks and vessels between x2 rubber-cushioned cross bars, for Innova® 2100/Innova® 40 /Innova® 42/Excella® 24	M1194-9909
Rod kit , for utility carrier (one additional rod), of Innova 40/42/2100 and Excella 24 lab shakers	M1194-9923
Utility tray with non-skid rubber surface for Innova® 2100, 40, 42 , usable as a stand-alone – no other platform required	M1194-9910
Drip pan , to catch accidental spills, for universal platform M1250-9902	M1250-9906
Photosynthetic light bank , programmable, Innova® 42R only - contact Eppendorf for installation options	M1335-0300
UV germicidal light , programmable, Innova® 42R only - contact Eppendorf for installation options	M1335-0400
Humidity monitor , for Innova® 42/42R - contact Eppendorf for installation options	M1335-0500
12-port gassing manifold , for Innova® 42/42R - contact Eppendorf for installation options	M1335-0600

✎ Ordering information for other voltage options can be found in the “Voltage Version” chapter.





New Brunswick Innova[®] 40/40R



Description

Do you need a compact benchtop orbital shaker that offers high visibility and quick access to flasks with a volume of up to 3 L? The Innova 40/40R is an easy-to-program orbital shaker that comes with the famous Innova triple eccentric drive to provide 24/7 reliable operation for decades.

Product features

- > **Check your samples:** Large, insulated, and scratch-resistant viewing provides a clear view of the chamber contents (device stops when lid is opened); holds flasks up to 3 L
- > **Built to perform and last:** Innova triple-eccentric counterbalanced drive in cast iron housing provides vibration and trouble-free operation for years
- > **Tight temperature and speed control:** Temperature accuracy and uniformity: ± 0.1 °C and ± 0.25 °C (at 37 °C; independent over-temperature cutoff included), speed accuracy 1 rpm

More info about the
Innova 40/40R
Download Flyer



[www.eppendorf.link/
flyer-Innova-40-40R](http://www.eppendorf.link/flyer-Innova-40-40R)



Ordering information

Description	Order no.
New Brunswick Innova® 40	
non-stackable, 230 V/50/60 Hz (CN/EU), orbit 1.9 cm (0.75 in)	M1299-0082
non-stackable, 230 V/50/60 Hz (CN/EU), orbit 2.5 cm (1 in)	M1299-0092
New Brunswick Innova® 40R	
refrigerated, non-stackable, 230 V/50/60 Hz (CN/EU), orbit 1.9 cm (0.75 in)	M1299-0086
refrigerated, non-stackable, 230 V/50/60 Hz (CN/EU), orbit 2.5 cm (1 in)	M1299-0096
Remote alarm option , for Innova® 44/44, Innova® 43/43, Innova® 42/42 or Innova® 40/40	M1320-8029
Platforms for Innova® 2100/40/40R/42/42R, Excella® E24/E24R , 46 × 46 cm (18 × 18 in), phenolic resin (unless otherwise stated)	
Universal platform, aluminum	M1250-9902
125 mL Erlenmeyer flask dedicated platform	M1194-9904
250 mL Erlenmeyer flask dedicated platform	M1194-9905
500 mL Erlenmeyer flask dedicated platform	M1194-9906
1 L Erlenmeyer flask dedicated platform	M1194-9907
2 L Erlenmeyer flask dedicated platform, for 2 L wide neck Erlenmeyer flasks (DIN-ISO 24450), bottom diameter ~153 mm. For 2 L narrow neck Erlenmeyer, Thomson, or Corning flasks (DIN-ISO 1773) bottom diameter ~166 mm refer to universal platform and clamps M1190-9004.	M1194-9908
Sticky pad platform for Innova® 40(R)/42(R)/2100, Excella® E24(R) , 46 × 46 cm (18 × 18 in), 4 sticky pads necessary to cover platform (sold separately, order no: M1250-9700), anodized aluminum	M1250-9903
Quick-change platform kit , enables platform attachment without tools, for Innova® 2100/4000/4080/4230	M1192-9901
Utility carrier , holds racks and vessels between x2 rubber-cushioned cross bars, for Innova® 2100/Innova® 40 /Innova® 42/Excella® 24	M1194-9909
Rod kit , for utility carrier (one additional rod), of Innova 40/42/2100 and Excella 24 lab shakers	M1194-9923
Utility tray with non-skid rubber surface for Innova® 2100, 40, 42 , usable as a stand-alone – no other platform required	M1194-9910
Drip pan , to catch accidental spills, for universal platform M1250-9902	M1250-9906

✎ Ordering information for other voltage options can be found in the “Voltage Version” chapter.





Shakers Accessories

Accessories	Order no.
Description	
Test tube rack, small, 30 × 8 × 12.9 cm	
diameter 8 – 11 mm, 48 tubes	M1289-0001
diameter 12 – 15 mm, 34 tubes	M1289-0002
diameter 15 – 18 mm, 24 tubes	M1289-0003
diameter 18 – 21 mm, 18 tubes	M1289-0004
diameter 22 – 26 mm, 13 tubes	M1289-0005
diameter 26 – 30 mm, 12 tubes	M1289-0006
Test tube rack, medium, 36 × 8 × 12.9 cm	
diameter 8 – 11 mm, 60 tubes	M1289-0010
diameter 12 – 15 mm, 44 tubes	M1289-0020
diameter 15 – 18 mm, 31 tubes	M1289-0030
diameter 18 – 21 mm, 23 tubes	M1289-0040
diameter 22 – 26 mm, 16 tubes	M1289-0050
diameter 26 – 30 mm, 16 tubes	M1289-0060
Test tube rack, large, 45 × 8 × 12.9 cm	
diameter 8 – 11 mm, 80 tubes	M1289-0100
diameter 12 – 15 mm, 60 tubes	M1289-0200
diameter 15 – 18 mm, 42 tubes	M1289-0300
diameter 18 – 21 mm, 30 tubes	M1289-0400
diameter 22 – 26 mm, 22 tubes	M1289-0500
diameter 26 – 30 mm, 20 tubes	M1289-0600
Clamp, for 1 L media bottles	ACSB-1000S
Clamp, for 500 mL media bottles and TPP Bioreactors 450 mL or 600 mL	ACSB-500S
Angled test tube rack holder, for user-supplied test tube racks and microplates	TTR-210
Angled Test Tube Rack Spacer Bar, for use with TTR-210	
to accommodate test tubes racks that are less than 13 mm (5 in) wide	TTR-215
Microplate rack, single layer, for single layer of five plates	TTR-221
Microplate rack, stack, stack three deepwell or nine standard plates	M1289-0700
Sticky tape, 23 m × 3.8 cm (75 feet × 1.5 in) roll	M1250-9600
Sticky pad, 20 × 20 cm (8 × 8 in), Compatible platform or adapter kit necessary	M1250-9700
Drip pan, to catch accidental spills, for use with universal platform M1250-9920	M1250-9921
Drip pan, to catch accidental spills, for universal platform M1250-9902	M1250-9906

8 – 11 mm: fits e.g. Eppendorf tubes 1.5 mL, 15 – 18 mm: fits e.g. 15 mL Conicals, 26 – 30 mm: fits e.g. 50 mL Conicals

Find the right lab shaker accessory



Shaker Accessory Guide

www.eppendorf.link/shaker-accessory-guide



Test tube racks



Shakers Accessories

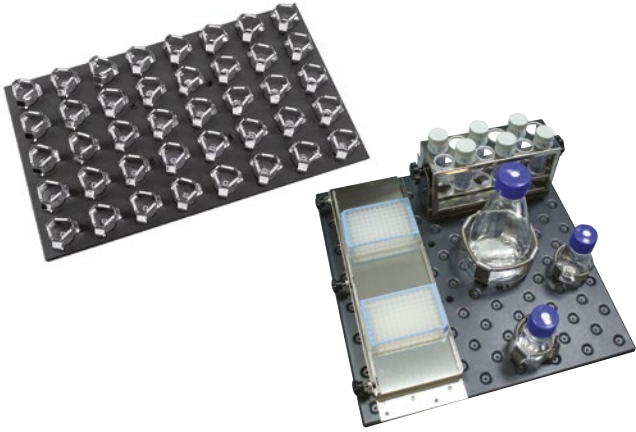

Various platform types



Lab shaker clamps

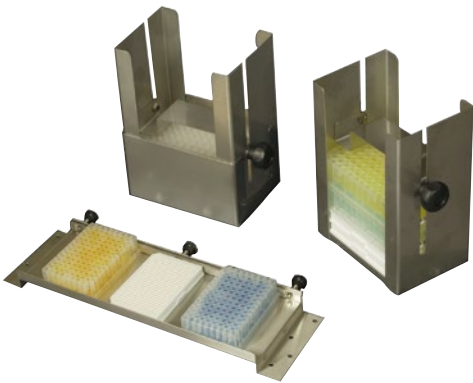

Microplate racks

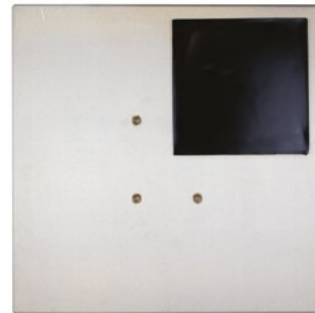

Sticky pad



Utility carrier



Utility Tray





Universal Platforms for Incubated Shakers

Universal Platforms and Clamps for Incubated Shakers

	Innova® S44i	Innova® 44/44R	Innova® 43/43R	Innova® 42/42R
Order no. universal platform	S44I040001	M1282-9904	M1250-9920	M1250-9902
	Clamps	Clamps	Clamps	Clamps
10 mL Erlenmeyer flasks	238	187	183	109
25 mL Erlenmeyer flasks	238	96	92	64
50 mL Erlenmeyer flasks	130	96	92	45
125 mL Erlenmeyer flasks	81	39	39	24
250 mL Erlenmeyer flasks	48	31	30	19
500 mL Erlenmeyer flasks	36	24	24	14
1 L Erlenmeyer flasks	20	14	12	8
2 L Erlenmeyer flasks*	14 ¹⁾	11	11	6
3 L Erlenmeyer flasks	9 ¹⁾	6	6	4
4 L Erlenmeyer flasks	8 ¹⁾	6	6	4
5 L Erlenmeyer flasks	6 ¹⁾	6 ²⁾	6 ²⁾	4 ³⁾
6 L Erlenmeyer flasks			4 ²⁾	2 ³⁾
2 L Lauber Thomson*	13	11	11	6
2.8 L Fernbach flasks	8	6	6	4
500 mL media bottle flasks	30	24	24	14
1 L media bottle flasks	20	13	13	8
Microplate rack, single layer	4	4	4	2
Microplate rack, stack	20	16	16	8
Test tube rack, small, 30 × 8 × 12.9 cm	12	9	9	5
Test tube rack, medium, 36 × 8 × 12.9 cm	10	8	8	4
Test tube rack, large, 45 × 8 × 12.9 cm	7	6	6	4
Platform size (cm/in)	76 × 62 cm (30 × 24 in)	76 × 46 cm (30 × 18 in)	76 × 46 cm (30 × 18 in)	46 × 46 cm (18 × 18 in)

* Note to 2 L clamps: ACE-2000S fits 2 L wide neck Erlenmeyer flasks (DIN-ISO 24450), max. bottom diameter ~158 mm. For 2 L narrow neck Erlenmeyer (DIN-ISO 1773), Thomson, or Corning flasks with max. bottom diameter of 166 mm refer to clamp M1190-9005 (Clamp, for 2 L Thomson flasks).

¹⁾ S44i: Maximum flask capacity limited to 1 L with installed shelf (removable), distance platform to ceiling ~43.7 cm, platform to shelf ~27 cm, platform to photosynthetic light bank ~40.6 cm.²⁾ Innova 43/44: Maximum flask size limited to 4 L with installed photosynthetic light bank. 144: Distance platform to ceiling ~46 cm, platform to photosynthetic light bank ~40 cm. 143: Distance platform to ceiling ~48 cm.

³⁾ Innova 42: Maximum flask size limited to 4 L with installed drawer, shelf or photosynthetic light bank (shelf and drawer removable, shelf adjustable in height). Distance platform to ceiling: ~47.7 cm, platform to drawer ~35.3 cm, platform to shelf (in position 5 from top) ~36.8 cm. ⁴⁾ New Brunswick S41i: Max. flask size with shelf in lower position limited to 250 mL Erlenmeyer or 500 mL Thomson Optimum Growth. Max. flask size with shelf in upper position limited to 1 L Erlenmeyer or 2.8 L Thomson Optimum Growth. Max. flask size without shelves 3 L and 5 L Corning and 5 L Thomson Optimum Growth. No fit of standard 5 L Erlenmeyer flasks (nn/wn). Platform to ceiling: ~40 cm, platform to lower shelf: ~18.5 cm, platform to upper shelf ~27.5 cm

Dedicated Platforms and Clamps for Incubated Shakers

	Innova® S44i		Innova® 44/44R		Innova® 43/43R	
	Clamps	Order no.	Clamps	Order no.	Clamps	Order no.
125 mL Erlenmeyer flasks	86	S44I040002	60	M1282-9905	60	M1191-9909
250 mL Erlenmeyer flasks	53	S44I040003	40	M1282-9906	40	M1191-9910
500 mL Erlenmeyer flasks	39	S44I040004	24	M1282-9907	24	M1191-9911
1 L Erlenmeyer flasks	23	S44I040005	15	M1282-9908	15	AG-1
2 L Erlenmeyer flasks*	15	S44I040006	12	M1282-9909	12	AG-2
2 L Lauber Thomson*	15	S44I040010				
Sticky pad platform**		Not required ¹⁾		M1282-9913		M1250-9904
Platform size (cm/in)	76 × 62 cm (30 × 24 in)		76 × 46 cm (30 × 18 in)		76 × 46 cm (30 × 18 in)	

* Note to 2 L clamps: For 2 L wide neck Erlenmeyer flasks (DIN-ISO 24450), max. bottom diameter ~158 mm refer to 2 L Erlenmeyer flask platforms. For 2 L narrow neck Erlenmeyer (DIN-ISO 1773), Thomson, or Corning flasks with max. bottom diameter of 166 mm refer to 2 L Lauber Thomson platforms.

** Sticky pads to be ordered separately see page 280

¹⁾ The universal platform of the Innova S44i and the New Brunswick S41 are designed to be compatible with sticky pads directly.



Lab Shaker Clamps

Innova® 40/40R M1250-9902	New Brunswick S41i M1334-9920
Clamps	Clamps
109	110
64	60
45	60
24	23
19	18
14	15 ⁴⁾
8	10 ⁴⁾
6	6 ⁴⁾
4	3 ⁴⁾
	3 ⁴⁾
6	6 ⁴⁾
4	3 ⁴⁾
14	15 ⁴⁾
8	8 ⁴⁾
2	
8	
5	6
4	3
4	3
46 × 46 cm (18 × 18 in)	46 × 46 cm (18 × 18 in)

Clamps	Clamps
Dimensions (W × H)	Order no.
31 × 26 mm	ACE-10S
23 × 22 mm	M1190-9004
51 × 26 mm	M1190-9000
68 × 37 mm	M1190-9001
91 × 47 mm	M1190-9002
102 × 48 mm	M1190-9003
130 × 64 mm	ACE-1000S
158 × 72 mm	ACE-2000S
189 × 112 mm	ACE-3000S
210 × 99 mm	ACE-4000S
222 × 145 mm	ACE-5000S
244 × 100 mm	ACE-6000S
165 × 112 mm	M1190-9005
203 × 73 mm	ACFE-2800S
92 × 108 mm	ACSB-500S
108 × 150 mm	ACSB-1000S
	TTR-221
	M1289-0700
	see page 14
	see page 14
	see page 14

Innova® 42/42R		Innova® 40/40R		New Brunswick S41i		Clamps
Clamps	Order no.	Clamps	Order no.	Clamps	Order no.	Dimensions (W × H)
34	M1194-9904	34	M1194-9904	32	M1334-9921	68 × 37 mm
25	M1194-9905	25	M1194-9905	24	M1334-9922	91 × 47 mm
16	M1194-9906	16	M1194-9906	15	M1334-9923	102 × 48 mm
9	M1194-9907	9	M1194-9907	11	M1334-9924	130 × 64 mm
5	M1194-9908	5	M1194-9908	6	M1334-9925	158 × 72 mm
	M1250-9903		M1250-9903		Not required ¹⁾	165 × 112 mm
46 × 46 cm (18 × 18 in)		46 × 46 cm (18 × 18 in)		36 × 61 cm (14 × 24 in)		



Bioprocess

»We help bring life-saving treatments to the world.«

Lina Tao, Senior Vice President, Eppendorf Bioprocess Unit

Bioprocess engineers develop and produce a multitude of products and ingredients available today. Their applications are diverse and the products can be found in the pharmaceutical, chemical, and nutritional industry. Within those branches, promising new bioprocess approaches, such as cell and gene therapies (CGT) or stem cell-derived novel food, start gaining momentum and open the door towards a new tomorrow. The progresses in the CGT field hold great potential to revolutionize how we will live in the future, but such progresses will only be possible with the help of the bioprocessing industry.

With our Eppendorf Bioprocess solutions, we are committed to help bring life-saving treatments to the world. Our bioprocess solutions are successfully used in the development of cell and gene therapies for

more than a decade and with our single-use stirred-tank bioreactor technology, we are aiming to provide the new gold-standard for this growing industry. By exploiting the strong synergies in bioreactor technology and polymer manufacturing, Eppendorf bioprocess has emerged as a global player and valuable resource to its customers. With our equipment, training programs, and application services, we support scientists in resolving cultivation bottlenecks from bioprocess development to production. In that way and in line with our corporate mission, we contribute to the efforts of our customers worldwide to improve human living conditions.



From Cell and Gene Therapy to Cultured Meat

Currently, we are entering an age where not only cell products but also the cell itself is the product of interest. Cell and gene therapies can facilitate treating diseases like cancer, for example by modulated immune cells or viral vectors that adjust immune responses accordingly. Cell therapy techniques aim to treat diseases by harnessing cells to deliver treatment. Alternatively, cell therapy can be used to repair or replace damaged tissue. Gene therapy aims towards restoring abnormal or dysfunctional expression patterns of a disease-related gene by introducing genetic material to replace, enhance or silence its function. In the same line, stem cell-based technologies are promising approaches for drug discovery and therapy. Moreover, new advances within the stem cell field even revolutionize how we will cultivate meat in the future.

Our bioprocess solutions enable the controlled cultivation of induced pluripotent stem cells (iPSCs), mesenchymal stem cells (MSCs) and

others to help establishing optimal and reproducible conditions for your process development. Single-use stirred-tank rigid-wall bioreactors are the key technology to overcome limitations of established 2D or bag-based cell cultivations. Our BioBLU® Single-Use Bioreactors are developed for high-density (stem) cell cultivation to overcome production bottlenecks through seamless scale-up and reproducible results.

Learn more about Eppendorf single-use bioreactors and examples for cell and gene therapy applications at:

www.eppendorf.link/cell-and-gene-therapy-development



Learn more about vaccines
www.eppendorf.link/vaccines



Learn more about antibodies
www.eppendorf.link/antibodies



From small scale to pilot/production scale, Eppendorf provides the bioprocess solution you need.

Antibodies/Hormones

Improved cultivation techniques such as perfusion and new possibilities in data handling and automation enhance the development of antibodies, therapeutic proteins, and active ingredients.

Eppendorf offers one of the most scalable and comprehensive single-use portfolios for cell culture applications on the market, for seamless process scale-up from R&D labs to pilot and manufacturing facilities.

Vaccines

Driven by events such as the COVID-19 pandemic and other governmental vaccination programs, there is a rising demand for development of new vaccines. Eppendorf bioprocess equipment helps companies in setting up flexible processes to balance costs and shorten time-to-market. Besides standard impellers, Eppendorf offers specialty impellers which can facilitate perfusion processes. For example, our packed-bed impeller uses Fibra-Cel® Disks as a solid support material for growth when secreted proteins are desired, e.g. from mammalian or insect cell culture.

Academic Customers

No matter which research area you are focusing on, we understand that universities and other publicly funded institutes are facing special challenges, such as frequently changing staff and often limited budgets. With flexible hardware and intuitive software tools, Eppendorf bioprocess systems support the various stages of discovery – from understanding a metabolic pathway to developing a commercially viable bioprocess. Specialists from Eppendorf will recommend equipment that meets your needs and budget.

Looking for
expert advice on
key bioprocessing
topics?



[www.eppendorf.link/
bioprocessing-intro](http://www.eppendorf.link/bioprocessing-intro)



Download the bioprocess family brochure
www.eppendorf.com/bioprocess-brochure

Our Portfolio – Your Choice



Model	DASbox® Mini Bioreactor System	DASGIP® Parallel Bioreactor Systems	SciVario® twin
Page	8	8	6
Working volume range ¹⁾	60 – 250 mL	0.2 – 1.8 L	0.2 – 40 L
Single-use vessels available	■	■	■
Glass vessels, autoclavable	■	■	■
Interchangeable vessels	■	■	■
Bacteria/yeasts/fungi	■	■	■
Mammalian/animal cells	■	■	■
Stem cells	■	■	Optional
Insect cells	■	■	Optional
Number of parallel units	Up to 24	Up to 16	2
Controller	PC	PC	Touchscreen
BioCommand®			
DASware®	■	■	■
Gas mixing options	4 gas (air, N ₂ , O ₂ , CO ₂)	4 gas (air, N ₂ , O ₂ , CO ₂)	4 gas (air, N ₂ , O ₂ , CO ₂)
Gas flow control ²⁾	TMFC	R or TMFC	TMFC
Exhaust analysis	■	■	■
Optical density measurement	■	■	■
Suitable for qualification for GMP			

¹⁾ Realized using multiple vessel sizes ²⁾ Gas Flow Controllers: R = Rotameter, TMFC = Thermal Mass Flow Controller





SciVario® twin



Description

The SciVario twin is a next generation bioprocess controller that evolves together with you. In a fast-changing field like modern biotechnology, working with a system that supports your current and future needs is indispensable. With an intuitive user-interface and highly innovative hardware and software, it enables flexibility for process optimization and readiness for the digital age.

Applications

- > Research and development in cell culture and microbiology
- > Lab scale fermentation of aerobic and anaerobic bacteria, yeasts as well as filamentous fungi
- > Cultivation of mammalian and human cell lines
- > Medium optimization
- > Clone and cell line screening, strain characterization

Product features

- > Customizable and flexible thanks to the innovative bay-drawer concept for further extension and reconfiguration
- > Integrated digital sensor technology (Mettler Toledo® ISM® and Hamilton ARC®), supporting analog sensors for pH and DO and optical DO sensors
- > Optional PreSens® optical DO sensor technology for BioBLU Single-Use Bioreactors

SciVario® twin

- 0.2 – 3.8 L working volume (autoclavable)**
- 0.25 – 40 L working volume (single-use)**



- > Variable speed pumps for accurate liquid addition and operation in batch and fed-batch mode
- > Wide range TMFC to allow for individual mixing of air, N₂, O₂, and CO₂ to headspace and/or submerged aeration



- > Individual or parallel operation of two glass and/or BioBLU Single-Use Bioreactors, in any combination of bioreactor types
- > Suitable for cell culture and microbial fermentation



- > Compact design, 16-40 cm of benchspace needed per bioreactor
- > Cable management guides for a clean and tidy setup



- > Intuitive and exciting new user interface supporting efficient and intelligent process control
- > Compatible with DASware® control software

SciVario twin
Video



www.eppendorf.link/SciVario-twin-video

SciVario twin
Brochure



www.eppendorf.link/One-for-All-brochure





DASbox® Mini Bioreactor System



DASbox® Mini Bioreactor System
60 – 250 mL working volume
(autoclavable)
65 – 250 mL working volume
(single-use)

www.ependorf.link/DASbox

Product features

- > 4-fold parallel system expandable to up to 24 bioreactors
- > Suitable for glass and/or BioBLU Single-Use Bioreactors, that can be used in any combination
- > Bioreactors can be run independently or in parallel
- > Suitable for cell culture and microbial fermentation
- > Compact mini bioreactor system: requires only 7 cm (3 inches) bench space per bioreactor
- > Optimal tool for DoE and scale-down approaches
- > Agitation control supporting overhead-driven Rushton, marine-type or pitched blade impellers
- > Innovative liquid-free temperature control system needs no cooling agent supply and supports independent temperature control for each bioreactor
- > Accurate monitoring and control of pH, DO, and level
- > Variable speed pumps for accurate liquid addition and operation in batch, fed-batch, continuous, and cyclic perfusion mode
- > Four mass flow controllers per bioreactor allow for individual mixing of air, N₂, O₂, and CO₂ to headspace and/or submerged aeration
- > Novel liquid-free Peltier exhaust condenser with easy to handle slide in – slide out activation and deactivation
- > DASware® control software for advanced process control
- > Compatible with DASware Software Suite for interconnectivity and bioprocess information management

DASGIP® Parallel Bioreactor System



DASGIP® Parallel Bioreactor System
200 mL – 1.8 L working volume
(autoclavable)
250 mL – 1.25 L working volume
(single-use)

www.ependorf.link/DASGIP-Parallel

Product features

- > Parallel operation of up to 16 glass or single-use bioreactors
- > DASGIP Bioblock for advanced and user-friendly temperature control
- > Suitable for cell culture and microbial fermentation
- > Modular design of control units allows for flexible system configurations that meet the demands of specific applications
- > Control of agitation, pH, level, and DO (including customizable cascade modes) in each bioreactor
- > Variable speed pumps for accurate liquid addition and operation in batch, fed-batch, continuous, and cyclic perfusion mode
- > Optical absorbance measurement for online calculation of e.g. OD₆₀₀ or cell dry weight
- > TMFC individual gas mixing of air, N₂, O₂ and CO₂
- > Online calculation of OTR, CTR and RQ
- > DASware control software for advanced process control
- > Compatible with DASware Software Suite for interconnectivity and bioprocess information management



BioFlo® 120



Product features

- > Flexible software platform for universal control of both microbial and cell culture applications
- > Auto Culture modes offer process control at the touch of a button
- > Compatible with BioBLU® Single-Use Bioreactors for fermentation and cell culture applications
- > Precise temperature control provided through interchangeable heat-blanketed or water-jacketed bioreactors
- > High precision TMFC for automatic gas flow control
- > Automatic gas mix for four independent sparge gas supplies
- > Available analog input/output connection for direct integration of accessories (i.e. scales, variable-speed pumps, etc.)
- > Integrated Mettler Toledo® ISM® platform
- > Compatible with DASware Software Suite or BioCommand for bioprocess information management



BioFlo® 120
0.4 – 10.5 L working volume
(autoclavable),
0.4 – 40 L working volume
(single-use)

[www.eppendorf.link/
BioFlo-120](http://www.eppendorf.link/BioFlo-120)

BioFlo® 320



Product features

- > Interchangeable autoclavable and BioBLU Single-Use Bioreactors
- > Integrated Mettler Toledo® ISM® platform
- > Control up to eight systems from a single user interface
- > Universal control for both microbial and cell culture applications
- > Field-upgradable TMFC drawers for sparge and overlay gas
- > Enhanced software package with new cascade and time profile features
- > Built-in optical pH sensing technology for use with the BioBLU Single-Use Bioreactors
- > DeltaV™ compatibility available through DeltaV Discovery and DeltaV ProPlus PAS
- > Up to six integrated pumps capable of operating in variable-speed mode
- > Eight independently controlled process gas supplies
- > Documentation packages available to help qualify the system for use in GMP environments
- > Compatible with DASware Software Suite or BioCommand for bioprocess information management



BioFlo® 320
0.6 - 10.5 L working volume
(autoclavable),
0.4 - 40 L working volume
(single-use)

[www.eppendorf.link/
BioFlo-320](http://www.eppendorf.link/BioFlo-320)





Bioprocess Autosampler



Product features

- > Aseptic operation without the use of a laminar flow cabinet
- > Compatible with differently-sized glass and BioBLU® Single-Use Bioreactors with working volumes of 60 mL to 1.8 L
- > Suitable for 1.5 mL and 10 mL sample vials, up to 648 samples can be stored
- > Enables regular sampling 24/7
- > Sample storage between 4 and 40 °C.
- > Sanitation procedure using ethanol is similar to procedures, usually applied when sampling manually
- > Low dead volume minimizes the reduction of culture volume
- > Modular design that facilitates expansion of the number of bioreactors to be sampled and retrofitting of existing bioprocess systems
- > Control of the Bioprocess Autosampler is integrated in DASware® control bioprocess software



Bioprocess Autosampler:
Modular autosampling solution for small and bench scale bioprocess systems

[www.eppendorf.link/
bp-autosampler](http://www.eppendorf.link/bp-autosampler)

BioFlo® 720



Product features

- > Compatible with Thermo Scientific™ HyPerforma™ 5:1 bioreactors from 50 L to 2,000 L
- > High performance Mass Flow Controllers capable of up to 500:1 turn-down allowing multiple bioreactor sizes to be run from the same controller
- > Suitable for analog and digital sensors Mettler-Toledo® ISM® and Hamilton® ARC®
- > Available with dual sparge, overlay and CO₂ stripping options
- > Field-upgradeable options for future expansion of the system
- > Documentation packages available to help qualifying the system for use in GMP environments¹⁾
- > Intuitive software tools such as Auto Calibrate and Auto Inflate reduce preparation time, maximizing system efficiency
- > Integrated Scale Up Assist software simplifies the workflow and calculations necessary to scale up and scale down
- > Flexible choices for single-use bioreactors (SUBs) and Bioprocess Containers (BPCs)
- > Mobile enclosure with a small footprint (0.7 m²/7.55 sq ft) fitting through a standard lab door
- > Watson-Marlow® peristaltic pumps for flow rates in a range of 1.2 mL/min - 3.3 L/min

¹⁾ BioFlo 720 is not a medical device as defined by the Food and Drug Administration or other regulatory authorities.



BioFlo® 720
Pilot- and Large-scale Single-Use bioreactor
50 – 2,000 L Working Volume

[www.eppendorf.link/
BioFlo-720](http://www.eppendorf.link/BioFlo-720)



Eppendorf Bioprocess Software – Much More Than Just Bioprocess Control

Eppendorf offers BioCommand as well as DASware control Supervisory Control and Data Acquisition (SCADA) software packages for advanced bioprocess control. The comprehensive DASware Software Suite provides next-generation bioprocess management.

DASware Software Suite

Next-generation bioprocess management:

A suite of smart and flexible software solutions to accelerate bioprocess development, with DASware control for parallel bioprocess control. The DASware licences enable interconnectivity of bioreactors and bioreactor controllers with external lab-devices, Design of Experiments (DoE), and integration into process control systems.



DASware control

> Advanced process monitoring, control, and data logging - for parallel cultivation with individual control of each bioreactor

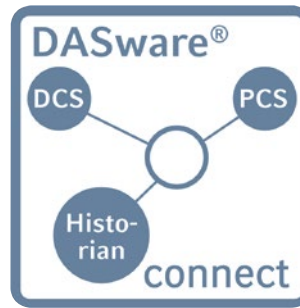

DASware connect

> Integration into process control systems and legacy corporate historians facilitating company-wide access to all relevant bioprocess data



DASware design

> Applies the Design of Experiments (DoE) concept via a full factorial DoE builder or by importing DoE designs from third-party DoE tools

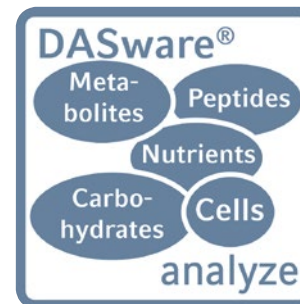

DASware analyze

> Seamless integration of external lab devices to the bioreactor allows for process automation and feedback control loops



BioCommand software

> Enables monitoring, controlling, and logging data from your fermentation and cell culture processes. Three distinct packages provide the tools needed for research, optimization, and if needed, the security and audit trails to support your regulatory requirements.





BioBLU® Single-Use Bioreactors



Description

With renowned polymer expertise, Eppendorf is proud to offer the largest portfolio of rigid-walled stirred-tank single-use bioreactors – for use in small and bench scale processes that are operated by parallel DASbox Mini Bioreactor System, DASGIP Parallel Bioreactor Systems, SciVario twin or BioFlo bench-scale systems.

BioBLU Single-Use Bioreactors combine the benefits of single-use bioreactor technology with the reliable performance of conventional glass or stainless-steel bioreactors.

Applications

- > The BioBLU c bioreactors are rigid-wall, stirred-tank, single-use bioreactors, specifically designed and optimized for cultivation of mammalian cells.
- > The BioBLU 5p bioreactor is a packed-bed bioreactor perfectly suited for adherent cells and perfusion culture. Pre-loaded with Fibra-Cel® disks, it provides a solid support growth matrix, e.g. for production of secreted proteins.
- > The BioBLU 0.3sc bioreactor is optimized for gentle stirring and cell aggregate formation to suit the special needs of stem cells.
- > The BioBLU f bioreactors for microbial applications were developed as true replacements for existing fermentation bioreactors. Utilizing an industrial standard, rigid-wall design, BioBLU f Single-Use Bioreactors allow microbial process development at the highest level.



Compared to Existing Glass Bioreactors, BioBLU Single-Use Bioreactors Have Many benefits:

- > Reduced costs for cleaning and sterilization qualification
 - > Reduced capital investment, use your existing equipment
 - > β -irradiated and autoclavable bioreactor options available
 - > Increased productivity with reduced turnaround time between runs
 - > Simplified handling reduces cross contamination
 - > Reliable scalability through industrial design
 - > Simplify installation with rigid-wall design, reduced potential for bioreactor damage
- > Single layer polymer design mitigates issues related to leachables and extractables
 - > Reduce the amount of lost runs due to sensor failure with non-invasive sensor options
 - > BioBLU bioreactors are compatible with a variety of Eppendorf benchtop bioprocess systems



BioBLU c Single-Use Bioreactors for cell culture applications

Single-use solutions for small and bench scale cell culture applications. A full portfolio of bioreactors covering working volumes of 100 mL – 40 L, offer unmatched scalability. The single-layer polymer design mitigates issues related to leachables and extractables.



BioBLU 5p Single-Use Bioreactor with packed-bed

For the cultivation of adherent cells and for perfusion processes we offer the BioBLU 5p packed-bed bioreactor. It utilizes the proprietary Eppendorf packed-bed impeller design and is pre-loaded with Fibra-Cel® Disks. Providing a shear-free environment, it is a premium choice for a wide variety of applications, including the production of secreted products and stem cell culture.



BioBLU f Single-Use Bioreactors for microbial applications

Single-use solutions for small and bench scale fermentation applications, covering a working volume range of 65 mL – 3.75 L. Fermentation processes have high mass transfer and heat removal requirements. Proven stirred-tank design, powerful overhead drives featuring Rushton-type impellers, and effective cooling enable the BioBLU f Bioreactors to achieve these demands.

Want to know more about BioBLU Single-Use Bioreactors?

Follow the links to the cell culture or microbiology bioreactors below to access our application notes, publications, and brochures.

Learn more about
BioBLU c Single-Use
Bioreactors



[www.eppendorf.link/
BioBLU-c](http://www.eppendorf.link/BioBLU-c)

Learn more about
BioBLU f Single-Use
Bioreactors



[www.eppendorf.link/
BioBLU-f](http://www.eppendorf.link/BioBLU-f)



Service Products



Supporting You for over 75 Years

Eppendorf Services

Eppendorf began in 1945 as a medical instrument repair workshop on the grounds of the University Hospital Eppendorf in Hamburg, Germany. Today, more than 500 certified service specialists across the world provide in-house or on-site service solutions, ensuring the uptime you need and can rely on, increasing your peace of mind in terms of supporting you to comply to regulatory requirements, and the quality and safety of your results.

Application and Training Services

Keep pace with new trends, methods and technologies by receiving training and application support from our global team of scientific product and application specialists. Acquire basic knowledge, or develop more advanced skills needed for your workflows and routine maintenance within scientific research, healthcare and industry.

Our dedicated Applications and Technical Service teams are here to support you!

Get all information about the Eppendorf Service portfolio!

www.eppendorf.link/epServices



Your Needs – Our Solutions

From service agreements to on-demand services – You choose the best solution for your uptime requirements and budget, while meeting national and international compliance with corresponding norms and regulations.

We take care of your equipment throughout their full lifecycle, while you can fully concentrate on achieving the reliable results you are looking for with your research and routine lab work.



Pipette Service Done Right

Since we released the first piston stroke pipette in 1961, we continue to manufacture and service pipettes with a passion for improving user results. Our highly qualified technicians undergo intensive training and must pass rigorous exams to become certified before servicing pipettes. We maintain over 5,000 pipette manufacturer specifications and conform to the manufacturer standard when their specifications are tighter than ISO 8655 standards, if requested. In our major markets, ISO 17025-accredited calibration processes are available. As your liquid handling expert partner, we can help you meet your regulatory needs.

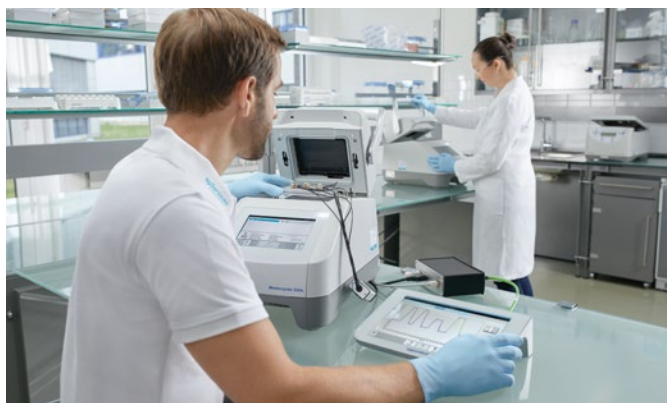

Your Instruments – Our Services

How much effort does it cost you to take good care of your lab instruments to ensure valuable uptime, and prove that they are delivering reproducible results? For your peace of mind, we offer a comprehensive service portfolio, so you can be assured of reliable and optimal working equipment in compliance with regulatory requirements. Trust in Eppendorf as your service partner.

Service Agreements

Extended Warranty Agreements



Installation
Service



Qualification
Service



Preventive
Maintenance



Calibration /
Verification



Repair
Service



Application
Support



Training /
Webinar

Knowledge Base

Various Application Notes, Short Protocols, FAQs, and videos are available on our website.

Exceeding your expectations
Download instrument brochure here!

www.eppendorf.link/epServices-instrument



Pipette service done right
Download pipette brochure here!

www.eppendorf.link/epServices-pipette



Service Products

Simplify Your Service Processes

We accompany you every step of the way – from the installation and maintenance of your lab instrument or software to the support for your quality and regulatory audits.

Choose from the following service options:

- > Service agreements from cost-efficient to all-inclusive care packages for an easy service process
- > On-demand service solutions for individual service needs
- > Do you have to spend your service budget now, but you need our services only at a later point in time? Please contact your local service organization for information on our prepaid solutions: www.eppendorf.com/service-support-form

Our Service Agreements – Your Advantages

With our basket of Service Agreement solutions, we take the load off your shoulders by simplifying your ordering and budgeting process:

- > Assuring continuous productivity
- > Maintenance for a long service life

- > Including repair costs: fully or partially
- > Discounting on additional services
- > Discounting with flexible prepaid services

Service Portal

- > In our web-based Service Portal you can easily and quickly register your pipettes, define required calibration intervals and book the pipette services you need from our extensive portfolio.

Keeping track of all of your calibration needs:

- > Free cloud-based backup of your pipette inventory service data
- > Define calibration intervals with reminders for upcoming services
- > Convenient, fast, and intuitive online booking of pipette services
- > Direct access to your service orders and documents
- > Overview of the status and history of your services

www.eppendorf.link/service-portal



Eppendorf Service Agreements



Service Agreement	AdvancedCare	PremiumCare
Full preventive maintenance	For assured instrument reliability and uptime 1/year	For assured instrument reliability, uptime and financial plannability 1/year
Software update (during annual maintenance, if applicable)	■	■
Priority support¹⁾	■	■
Parts, labor, travel on repairs	20 % discount	included
Discount on additional services (e.g. IQ/OQ)	10 %	10 %

¹⁾ Subject to local business conditions, and based on a "best effort" practise. For more information please contact your local service organization.



Extended Warranty Agreements

For your peace of mind, we offer Extended Warranty agreements covering all repair costs and optional maintenance after the standard warranty period.

Service Agreement	Extended Warranty	Extended Warranty plus
Full preventive maintenance	Purchased one time within the standard warranty period. Valid for one year following the standard warranty period.	Purchased within the standard warranty period. Valid following the standard warranty period.
Software update (during annual maintenance, if applicable)	–	1/year
Priority support ¹⁾	–	■
Parts, labor, travel included on repairs	■	■
Discount on additional services (e.g. IQ/OQ)	–	10 %

¹⁾ Subject to local business conditions, and based on a "best effort" practise. For more information please contact your local service organization.

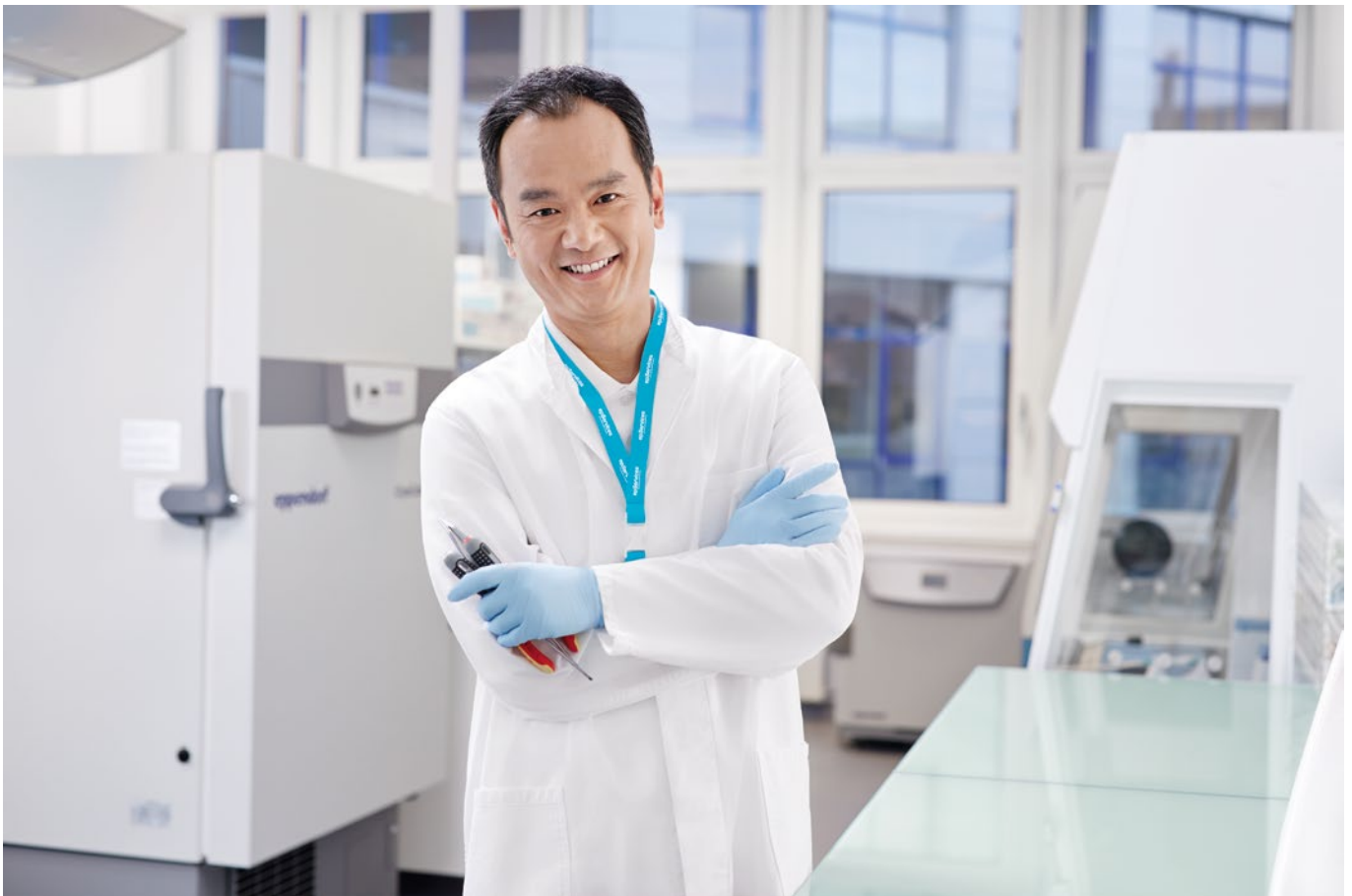

Service Products



Installation Service

The installation of your Eppendorf instrument and software will be performed by our certified service technicians. They will support you with the correct instrument settings in your environment, and will provide the initial operational instructions.



Qualification Services

Installation Qualification and Operational Qualification Services supporting GxP compliance

Are you working in a regulated environment? We offer specifically created and revised Installation Qualification and Operational Qualification services including GxP compliant documentation. These documents support you in fulfilling the complex GxP standards, reducing your administrative

workload, and provide you with qualified assurance that your instrument is installed and is operating in accordance with manufacturers' specifications.

Be prepared for your internal and external audits with our GxP supporting documentation!

Installation Qualification & Operational Qualification Services	IQ/OQ GxP	OQ GxP
Check of delivery status, and installation environment	■	
Installation incl. configuration and functional checks	■	
Detailed IQ report	■	
Test of alert functions	■	■
Verification of instrument parameters (e.g. temperature, speed)	■	■
Detailed OQ report	■	■
Handling of deviation list	■	■
Signed approval by customer and service technician	■	■



Maintenance Services

Preventive Maintenance Services

How much do you rely on keeping your instrument in good working order? Our professional maintenance services are aimed at the prevention of unexpected downtimes and failures by early detection of problems.

Keeping your instrument in perfect working order will not only extend their service life but also increase your productivity.

Services include:

- > Cleaning (external and internal)
- > Maintenance
- > Exchange of wear and tear parts
- > Comprehensive functional check
- > Software updates
- > Evaluation of stored data
- > Documentation
- > Dated service sticker to confirm Eppendorf Service

Ensure reliability and save your resources!



Calibration / Verification Services

Calibration and Verification Services

Assuring the precision and accuracy of your instrument is maintained according to specifications is your first step to reliable results.

Eppendorf offers calibration, verification and adjustment services for:

- > Pipettes and Dispensers (volume)
- > epMotion® 5073/5075 (volume, temperature, speed)
- > Centrifuges (time, speed, temperature)
- > Thermocycler (temperature)
- > Biological Shaker (speed, temperature)
- > CO₂ Incubator (temperature, CO₂, O₂, rH)
- > ULT Freezer (temperature)
- > Photometry (wavelength, temperature i.a.)
- > Temperature control- & Mixing instruments (i.a. temperature)



Repair Service

For the most productive long life and highest uptime of your Eppendorf instrument, we can provide complete and thorough technical support. Our qualified service staff

ensures timely and accurate resolutions and provides professional guidance and care worldwide. For any technical support please contact your local service organization.



Application Support

You can expect the highest standards of support for your products and applications from Eppendorf. Our highly trained

scientific support staff is available in all time zones to assist you with any questions concerning our products.



Training & Webinar

The Eppendorf Training Center has been providing high-quality webinars and training courses since 1997 at various locations and in several languages. Contents are constantly being updated to always include the latest insights into the scientific fields. We work with small groups to ensure optimal attention and sufficient hands-on time for our participants.



Download your
decontamination
form to return
goods:



[www.eppendorf.link/
decontamination](http://www.eppendorf.link/decontamination)



Pipette Calibration Service



Preventive Maintenance, Calibration and Adjustment Services

Pipettes are precision instruments with parts subject to normal wear and tear leading to imprecision over time. Therefore, regular maintenance and calibration are fundamental to their precision and accuracy. Calibration services performed by highly trained and certified Eppendorf Calibration Service Technicians build the foundation of your reliable and reproducible results with your downstream applications.

Our newly, clearly designed calibration service portfolio includes a thorough check of the pipette internally and externally, ensuring that wearable parts like O-rings are replaced in a timely manner.

We offer a range of transparent and modular service options

- > We maintain every pipette's conformity according to ISO 8655:2022 (if available in your country)
- > ISO 17025 accredited certification

For more information on Service Agreements options for multiple pipettes contact your local service organization or go to www.eppendorf.link/pipette-service



Take a break,
watch this video!

www.eppendorf.link/pipette-video

Pipette Calibration Services Ordering Information

Service	Calibration measurements "As Is"	Calibration measurements "As Left"	Decontamination from the outside ¹⁾	Checking, cleaning, lubricating ²⁾ before calibration
ISO 8655 without Preventive Maintenance	10 per test volume		included	
ISO 8655 including Preventive Maintenance		10 per test volume	included	included
3x4 without Preventive Maintenance	4 per test volume		included	
3x4 including Preventive Maintenance		4 per test volume	included	included

¹⁾ Pipettes and dispensers and package equipment need to be decontaminated before sending in. Download decontamination form at www.eppendorf.com/decontamination. ²⁾ Internal parts

Pipette Calibration Service Packages Ordering Information

Service	Calibration measurements "As Is"	Calibration measurements "As Left"	Outside decontamination ²⁾ , checking, cleaning, lubrication ⁴⁾	ISO 17025 Accreditation calibration certificate
ISO 8655 Verified	4 per test volume ¹⁾	10 per test volume ¹⁾	included	
ISO 17025 including Preventive Maintenance		10 per test volume ¹⁾	included	included
ISO 17025 Advanced	4 per test volume ¹⁾	10 per test volume ¹⁾	included	included ³⁾
ISO 17025 Professional	10 per test volume ¹⁾	10 per test volume ¹⁾	included	included

¹⁾ 10%, 50% and 100% of nominal volumes for variable volume instruments. ²⁾ Pipettes and dispensers and package equipment need to be decontaminated before sending in. Download decontamination form at www.eppendorf.com/decontamination. ³⁾ ISO 17025 accreditation calibration certificate is included in the second calibration after the maintenance. ⁴⁾ Internal parts

ISO 8655

ISO 8655 lays out the standard criteria by which a pipette should be calibrated and what error limits should be used at each volume. ISO 8655 criteria include measurements at 3 volumes, 10 measurements at each volume, and controls for room environment.

Manufacturer Standard

In addition to ISO 8655 specifications, many manufacturers make pipettes that work within a tighter set of error limits than required by ISO 8655. It is important to calibrate using manufacturer error limits to ensure the pipette works according to manufacturer specifications.

ISO 17025

The ISO 17025 accreditation ensures a high level of competence and compliance with strict quality rules. ISO 17025 criteria include a traceability chain for measurement equipment, measurement uncertainty values, and approved quality standards.

We ensure our stringent and validated procedures are followed to the highest standards possible, for Eppendorf and other brand pipettes.

Description of Additional Services	Order no.
Labor Charge, 15 min. of repair services, time unit of one technician	0082000210
ISO 17025 Calibration Certificate ²⁾	0082000211
Advanced Documentation, Excel file for calibration information on all pipettes/dispensers per order ¹⁾²⁾	0082000212
On-site calibration services in your own laboratory ²⁾	please inquire

¹⁾ ISO 17025 accreditation calibration certificate is included in the second calibration after the maintenance. ²⁾ This service may be available in your country. Please contact your local Eppendorf service organization.

Single Channel Pipette/ Dispenser	8-Channel Pipette	12-Channel Pipette	16-Channel Pipette	24-Channel Pipette
0082000140	0082000161	0082000162	0082000181	0082000182
0082000142	0082000165	0082000166	0082000185	0082000186
0082000139	0082000159	0082000160	0082000179	0082000180
0082000141	0082000163	0082000164	0082000183	0082000184

Single Channel Pipette/ Dispenser	8-Channel Pipette	12-Channel Pipette	16-Channel Pipette	24-Channel Pipette
0082000234	0082000235	0082000236	0082000237	0082000238
0082000143	0082000167	0082000168	0082000187	0082000188
0082000227	0082000228	0082000229	0082000230	0082000231
0082000220	0082000221	0082000222	0082000223	0082000224



epMotion® 96 Service



epMotion 96 Service

The Eppendorf epMotion 96 is a semi-automated electronic pipette system for fast and precise parallel 96-channel microplate processing. The reliability of the electronic parallel pipetting system movement is the prerequisite for high precision and reproducibility of the results across the whole 96- or 384-well plate. Maintaining and verifying your system's accuracy and precision on a regular basis is highly recommended to make sure your system still dispenses according to the specification.

Preventive Maintenance services include:

- > Cleaning and lubrication of dispensing head
- > Checking and exchanging of 96 O-rings from cones
- > Software/firmware update if applicable
- > Leak Test (50 µL + 300 µL)
- > Service check list
- > Dated service sticker to confirm Eppendorf Service
- > Calibration Report

Qualification services include:

- > Checking of
 - > delivery status, and environment
 - > installation incl. configuration and functions
- > Testing of alert functions
- > Verification of instrument parameters (e.g. volume)
- > Detailed IQ/OQ report
- > Handling of deviation list/management
- > Signed approval by customer and service technician

96 x confidence by verified performance!

epMotion® Service



epMotion Service

epMotion and its dispensing tools are precision instruments. As such, they should be regularly maintained and calibrated to ensure continuing high accuracy, precision and reproducibility.

Preventive Maintenance services include:

- > Cleaning (external and internal)
- > Maintenance, instrument calibration software update
- > Exchange of CAN bus cables/O-rings of dispensing tools
- > Comprehensive functional check
- > Evaluation of stored data
- > Service check list
- > Dated service sticker to confirm Eppendorf Service

Qualification services include:

- > Checking of
 - > delivery status, and environment
 - > installation incl. configuration and functions
- > Testing of alarm functions
- > Verification of instrument parameters (e.g. temperature, vacuum, speed, volume)
- > Detailed IQ/OQ report
- > Handling of deviation list/management
- > Signed approval by customer and service technician

Calibration services for dispensing tools

How do you know that your experimental data are correct? Your first step to reliable results is to ensure your dispensing tools are calibrated, assuring the:

- > Accuracy and precision of the dispensing tool
- > Reproducibility of the dispensed volumes
- > Optimization of sample yields

Keep your process in motion with regular maintenance and calibration services!



epMotion® Application Implementation



Automated Pipetting – Difficult Application?

Are you having trouble with a protocol or are not sure how to optimize your automated application? We are happy to advise and assist you with your application. Eppendorf offers various application support services for epMotion users with low to high throughput experiments. Our network of highly skilled and extensively trained In-Field Automation Specialists is available for comprehensive application training and support after installation of your epMotion as well as during the setup of your own advanced methods.

Application Implementation

Eppendorf will provide the on-site support to program your epMotion methods for a single application as well as optimize all liquid classes needed for the application to the best of the instrument's capability. An initial in-house feasibility test is performed. Upon completion of the method on the customer's epMotion, the application will be approved by the user. Optimization to the maximum level of performance!

For your next level of performance!

Your advantages

- > Well trained Application Specialist will get you started with your methods in less time than without professional help
- > Approved reliability of your programmed method
- > Shortening your protocol setup times and reducing your personnel costs
- > Reducing waste of valuable samples
- > Improving productivity with optimized utilization of the deck capacities and the operation of the system

All systems go -
At all times
Download epMotion
brochure here!



[www.eppendorf.link/
epServices-epMotion](http://www.eppendorf.link/epServices-epMotion)

Centrifuge Service



Centrifuge Service

Regular service of centrifuges and rotors in either an operational or a disassembled state ensures a safe working environment. Functional inspections assure that all manufacturer specifications are met.

Preventive Maintenance services include:

- > Cleaning of external and internal parts
- > Checking of
 - > stability, housing, lid latch, display and keypad
 - > temperature sensors and speed sensor
 - > rotor and imbalance detection
- > Software update, if required
- > System test run
- > Evaluation of stored data
- > Service check list
- > Dated service sticker to confirm Eppendorf Service

Relax while your samples are spinning safely!

Qualification services include:

- > Checking of
 - > delivery status, and environment
 - > installation incl. configuration and functions
- > Testing of alert functions
- > Verification of instrument parameters (temperature, speed)
- > Detailed IQ/OQ report
- > Handling of deviation list/management
- > Signed approval by customer and service technician

Rotor Assurance Plans

Rotors and buckets are subject to normal wear and tear during regular operation. Microscopic cracks can be detected early during a qualified inspection, which will allow the rotor to be exchanged before serious damage has occurred. If none or very few surface changes are identified, the rotor can be used according to instructions.

Take a break,
watch this video!



www.eppendorf.link/centrifuge-video



Ultra- and High-Speed Centrifuge Service



Ultra- and High-Speed Centrifuge Service

Your centrifuge from our Himac centrifuge product line is now supported by Eppendorf. Our qualified staff ensures timely and accurate solutions are provided with professional guidance and care. Maintain and qualify your laboratory instruments on a regular basis with our service agreement options and on-demand services for many years of productive and reliable operation.

Preventive Maintenance services include:

- > Cleaning of external and internal parts
- > Checking of
 - > stability, housing, lid latch, display and keypad
 - > temperature sensors and speed sensor
 - > rotor and imbalance detection
- > Software update, if required
- > System test run
- > Service check list
- > Dated service sticker to confirm Eppendorf Service

Qualification services include:

- > Checking of
 - > delivery status, and environment
 - > installation incl. configuration and functions
- > Testing of alert functions
- > Verification of instrument parameters (temperature, speed)
- > Detailed IQ/OQ report
- > Handling of deviation list/management
- > Signed approval by customer and service technician

Save time by ensuring uptime and reproducible results!

Find our
service flyer



www.eppendorf.link/service-ultra-centrifuge

Mastercycler® Service



Mastercycler Service

Your cycler should be regularly maintained, and followed by a temperature verification. The exact adherence to defined temperatures is crucial for reproducible results.

Preventive Maintenance services include:

- > Cleaning of external and internal parts
- > Checking of
 - > housing, accessories and internal parts
 - > electrical connection (incl. mains power)
 - > LED, display and keyboard, touchscreen
 - > USB-interface
 - > thermoblock
 - > heated lid
 - > fan(s)
- > Software update if required
- > Verification of temperature
- > Evaluation of stored data
- > Service check list
- > Dated service sticker to confirm Eppendorf Service

Qualification services include:

- > Checking of
 - > delivery status, and environment
 - > installation incl. configuration and functions
- > Testing of alert functions
- > Verification of instrument parameters (e.g. temperature)
- > Detailed IQ/OQ report
- > Handling of deviation list/management
- > Signed approval by customer and service technician

Temperature verification services

Temperature verification of selected well positions and adjustment of the cycler block temperature if necessary is highly recommended to assure instrument consistency and accuracy. The temperature verification from Eppendorf is a very accurate and precise method, meeting all documentation and detection requirements in the lab.

Keep operating – with absolute confidence



Temperature Control and Mixing Service



Temperature Control and Mixing Service

Slight deviations in temperature and mixing frequency of your samples can affect their reaction conditions leading to non-reproducible results. To guarantee you the precise function of the instrument we offer manufacturer-designed maintenance and qualification services.

Preventive Maintenance services include:

- > Cleaning of housing, accessories, internal parts
- > Checking of
 - > housing, plate holder, accessories, internal parts
 - > electrical connection
- > Function checking of
 - > LED, display and keyboard
 - > vortex sensor
 - > overload protection
 - > detection of ThermoTop, SmartBlock, thermoblock
 - > mixing, heating, cooling, vortexing
 - > fans
- > Evaluation of stored data
- > Service check list
- > Dated service sticker to confirm Eppendorf Service

Qualification services include:

- > Checking of
 - > delivery status, and environment
 - > installation incl. configuration and functions
- > Testing of alert functions
- > Verification of instrument parameters (e.g. heating, cooling, mixing, vortexing, timer)
- > Detailed IQ/OQ report
- > Handling of deviation list/management
- > Signed approval by customer and service technician

Temperature Verification

Temperature verification of selected well positions is highly recommended to assure instrument consistency and accuracy.

Care for your samples with our mix of services!

ULT Freezer Service



ULT Freezer Service

Reliable and efficient performance can be expected for years of smooth operation from any of our ULT Freezers. Our services are designed to check, validate, and promote reliable freezer performance according to specifications.

Preventive Maintenance services include:

- > Cleaning and inspection of air filter, heated vent/condenser
- > Checking of
 - > environment, electrical supply and fittings
 - > CO₂ /LN₂ backup system
 - > independent temperature monitoring system
 - > compressor operating temperature
 - > condition and function of inner door/lids, cooling fan
 - > motor, bearings, blades, insulation, accessible cooling
 - > circuit pipes, and accessible electrical wiring
- > Operation of
 - > freezer lid gas strut (chest freezer)
 - > display and function keys
 - > chamber temperature sensors and alert
 - > RS232/RS485 communication port
- > Alignment of door handle/sealing of outer door (upright freezer)
- > Verification and adjustment of operating parameters
- > Service check list
- > Dated service sticker to confirm Eppendorf Service

Qualification services include:

- > Checking of
 - > delivery status, and environment
 - > installation incl. configuration and functions
- > Testing of alert functions
- > Verification of instrument parameters (e.g. temperature)
- > Basic IQ/OQ report

Protect your priceless samples!

How to protect
precious samples
in your Eppendorf
ULT freezer:



[www.eppendorf.link/
epServices-freezer-video](http://www.eppendorf.link/epServices-freezer-video)



ULT Freezer Service

Multi-Temperature Mapping for Ultra-Low Temperature Upright Freezer

Regular verification with the help of an external, calibrated multi-channel temperature verification system inside your ULT freezer provides you with the security of reliable long-term sample storage.

Our factory-trained and certified service technician will perform an on-site temperature mapping study including a full report stating:

- > Minimum, maximum and average temperature of each location
- > Full log of raw data of each measurement
- > Temperature profile graphic for duration of measuring period
- > All relevant calibration certificates

Norms, standards and best practices such as ISPE-Controlled Temperature Chamber Mapping and Monitoring, IEC 60068 - Environmental testing, or Vaisala – 5 Rules of Sensor Placement in Validation/Mapping Applications recommend a temperature mapping of 9 or 15 probes after installation, and subsequently every two years, or when changes are made to the system.

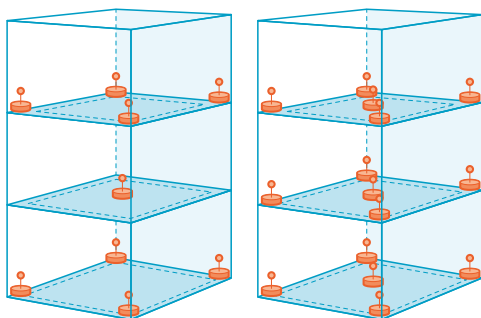

A probe holder system (9 and 15 probes) is used to ensure comparable results between different measurements and units

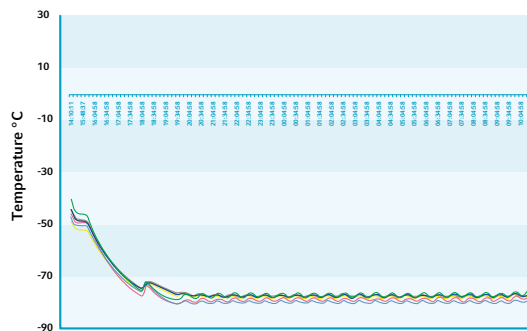

Example of a Multi-Temperature Mapping with 9 probes inside an ULT upright freezer

Your advantages

- > 24 hours, 365 days a year reliable storage for temperature-sensitive samples
- > Comparable annual temperature distribution results in one or multiple freezers
- > Audit proof documentation

This service is only available in selected countries. Please contact your local Eppendorf service organization for further information.

Poster maintenance
ULT freezer



[www.eppendorf.link/
epServices-freezer-poster](http://www.eppendorf.link/epServices-freezer-poster)

CO₂ Incubator Service



CO₂ Incubator Service

CO₂ incubators feature complex, dynamic control systems to maintain user-defined culturing parameters for optimized cell growth and proliferation. To ensure reproducible results and to protect your precious cultures from undesirable variables, we check and validate your incubator performance.

Preventive Maintenance services include:

- > Checking of
 - > installation environment
 - > electrical/gas supply and fittings
 - > door seals and door hinges
 - > all chamber gas, temperature, humidity sensors
 - > security of incubator shelf and racking systems
 - > sensor covers
 - > humidity trays
 - > wiring system, PCB's, display, and controller
- > Testing of alert functions
- > Replace in-line gas filter(s) and auto-zero filter
- > Validation/adjustment of operating parameters within specifications
- > Service check list
- > Dated service sticker to confirm Eppendorf Service

Qualification service include:

- > Checking of
 - > delivery status, and environment
 - > installation incl. configuration and functions
- > Testing of alert functions
- > Verification of instrument parameters (e.g. temperature, CO₂, speed, alert)
- > Detailed IQ/OQ report

For CellXpert®:

- > Detailed IQ/OQ report
- > Handling of deviation list/management
- > Signed approval by customer and service technician

Our service culture for peace of mind!



S41i Incubator Shaker Service



S41i Incubator Shaker Service

The versatility of the S41i Incubator Shaker supports simultaneous culture of adherent and suspension cultures. The smallest deviations in the culturing environment can result in undesirable outcomes. To ensure reproducible results and to protect your precious cultures from undesirable variables, we offer a range of maintenance and qualification services.

Preventive Maintenance services include

- > Checking of
 - > electrical/gas supply and fittings
 - > chamber CO₂, temperature sensors
 - > security of shaker platform(s) and flask holders
 - > security of incubator shelf and racking systems
 - > humidity trays
 - > shaker drive belt
 - > platform support boot seals
- > Replace
 - > in-line CO₂ filter and auto-zero filter
- > Validation/adjustment of operating parameters within specifications
- > Service check list
- > Dated service sticker to confirm Eppendorf Service

Qualification services include:

- > Checking of
 - > delivery status, and environment
 - > installation incl. configuration and functions
- > Testing of alert functions
- > Verification of instrument parameters (e.g. temperature, CO₂, speed, alert)
- > Detailed IQ/OQ report

Achieve reliable culturing results with optimized performance of incubating and shaking systems!

How to clean your incubator:



www.eppendorf.link/epServices-incubator

Biological Shaker Service



Biological Shaker Service

Biological shakers are required to be in continuous use for years. Small and short-term variations in shaker operation can influence culturing outcomes, with negative effects on yields and/or cell expression. Ensure consistent, reliable shaker performance with our shaker services.

Preventive Maintenance services include:

- > Cleaning of condenser
- > Lubricate non-sealed shaker bearings, as appropriate
- > Checking of
 - > installation environment
 - > electrical/gas supply and fittings
 - > any door/lid open sensors
 - > security of doors/lids, handles, door struts and hinges
 - > security of shaker mechanism
 - > shaker drive motor, and circulation fan
 - > shaker drive belt; adjust belt tension as necessary
- > Validation/adjustment of operating parameters within specifications
- > Service check list
- > Dated service sticker to confirm Eppendorf Service

Qualification services include:

- > Checking of
 - > delivery status, and environment
 - > installation incl. configuration and functions
- > Testing of alert functions
- > Verification of instrument parameters (e.g. rpm, temperature, alerts)
- > Detailed IQ/OQ report
- > Handling of deviation list/management
- > Signed approval by customer and service technician

Care for your shaker – Optimize your cultures!



Photometry Service



Photometry Service

To optimize photometric and fluorometric precision, accuracy, and linearity, your instrument should be routinely checked and adjusted by a qualified Eppendorf Service Technician.

Preventive Maintenance services include:

- > Cleaning of housing and cuvette shaft
- > Checking of
 - > housing (incl. stability) and cuvette shaft
 - > internal parts, light path, keyboard, display
 - > printer output and USB port
- > Software update
- > Setting number of flashes
- > dsDNA Test - 260 nm (Biophotometer plus)
- > Self Test (Biospectrometer/Biophotometer D30)
- > Photometer Test (wavelength systematic error/precision and photometric accuracy/fluorescence)
- > Temperature verification/adjustment
- > Evaluation of stored data
- > Service check list
- > Dated service sticker to confirm Eppendorf Service

Qualification services include:

- > Checking of
 - > delivery status, and environment
 - > installation incl. configuration and functions
- > Testing of alert functions
- > Verification of instrument parameters (e.g. wavelength, temperature)
- > Detailed IQ/OQ report

Stay tuned to the right wavelength!

Photometer Test

You are also able to verify photometric and wavelength accuracy and the respective precision using the Secondary UV-VIS Filter Set. In the event your instrument does not conform to specifications, you must have it checked and properly adjusted by a trained service technician. The filter sets themselves must be inspected every two years as their spectral properties can change over time. Your filter set must be tested, maintained and certified directly by the manufacturer at Eppendorf's plant.

Check how to clean and maintain your Eppendorf μ Cuvette



www.eppendorf.link/epServices-Cuvette

Service Agreements and Qualification Services Ordering Information

Ordering Information	AdvancedCare Agreement	PremiumCare Agreement	IQ/OQ GxP	OQ GxP	1 Year Extended Warranty ¹⁾	1 Year Extended Warranty plus ²⁾
	Assured instrument reliability and uptime	Full coverage for instrument reliability and uptime	Qualification services for the regulated environment	Re-Qualification services for the regulated environment	Parts, labor and travel cost are covered in case of a repair	Full coverage for repair, including maintenance for reliability
epMotion® 5070	0082030105	0082030107	0082030030	0082030040	0082030100	0082030102
epMotion® 5073	0082030106	0082030108	0082030031	0082030041	0082030101	0082030103
epMotion® 5075	0082030073	0082030075	0082030032	0082030042	0082030069	0082030071
epMotion® 96	0082030074	0082030076	0082030036	0082030016	0082030070	0082030072
Microcentrifuge w/o refrigeration	0082020325	0082020320	0082020300	0082020305	0082020340	0082020345
Microcentrifuge with refrigeration	0082020326	0082020321	0082020301	0082020306	0082020341	0082020346
Multipurpose centrifuge w/o refrigeration	0082020327	0082020322	0082020302	0082020307	0082020342	0082020347
Multipurpose centrifuge with refrigeration	0082020328	0082020323	0082020303	0082020308	0082020343	0082020348
Multipurpose Centrifuge 592x	0082020331	0082020330	0082020303	0082020308	0082020343	0082020348
High-Speed Centrifuge	0082029327	0082029321	0082029221	0082029227	0082029341	0082029347
Micro Ultracentrifuge	0082029328	0082029319	0082029220	0082029226	0082029339	0082029345
Ultracentrifuge	0082029326	0082029320	0082029220	0082029226	0082029340	0082029346
Vacuum Concentrator	0082020329	0082020324	0082020012³⁾	0082020011³⁾	0082020344	0082020349
Mastercycler®	0082040325	0082040320	0082040300	0082040301	0082040340	0082040345
ULT Freezer	0082070325	0082070320	0082070009³⁾	0082070008³⁾	0082070340	0082070345
CO ₂ Incubator	0082060325	0082060320	0082060009³⁾	0082060008³⁾	0082060340	0082060345
CellXpert®	0082060325	0082060320	0082060302	0082060303	0082060340	0082060345
Incubator Shaker S41i	0082050325	0082050320	0082050300	0082050301	0082050340	0082050345
Shaker - open air	0082080325	0082080320	0082080300	0082080305	0082080340	0082080345
Shaker - heating	0082080326	0082080321	0082080301	0082080306	0082080341	0082080346
Shaker - heating & cooling	0082080327	0082080322	0082080302	0082080307	0082080342	0082080347
Shaker - S44i	0082080329	0082080324	0082080304	0082080309	0082080344	0082080349
Eppendorf BioPhotometer®	0082110325	0082110320	0082110300	0082110302	0082110340	0082110345
Eppendorf BioSpectrometer®	0082110326	0082110321	0082110301	0082110303	0082110341	0082110346
Temperature control & mixing instruments ⁴⁾	0082100325	0082100320	0082100300	0082100301	0082100340	0082100345

¹⁾ Purchased once within the standard warranty period. Valid for one year following the standard warranty period. ²⁾ Purchased within the standard warranty period. Valid following the standard warranty period.
³⁾ Non-GxP compliant. ⁴⁾ Eppendorf ThermoMixer™/Eppendorf ThermoStat, MixMate®



Service Products

Further Services

epMotion® and Other Services Ordering Information	Order no.
1-channel dispensing tool calibration - 10 measurements per test volume (min, mid, max)	0050600255
8-channel dispensing tool calibration - 10 measurements per test volume (min, mid, max)	0050600259
1-channel dispensing tool calibration - 4 measurements per test volume (min, mid, max)	0082030077
8-channel dispensing tool calibration - 4 measurements per test volume (min, mid, max)	0082030078
UV lamp exchange	5073920070

Info: Our service offers may differ by country. Please contact your local service representative for more information.

Instrument Installation and Maintenance Services Ordering Information	Installation Services	Preventive Maintenance	Device Check
epMotion® 5070	0082030081	0082030010	N/A
epMotion® 5073	0082030111	0082030011	N/A
epMotion® 5075	0082030141	0082030012	N/A
epMotion® 96	0082030171	0082030002	N/A
Microcentrifuge w/o refrigeration	0082020101	0082020260	0082020270
Microcentrifuge with refrigeration	0082020131	0082020261	0082020271
Multipurpose Centrifuge w/o refrigeration	0082020161	0082020262	0082020272
Multipurpose Centrifuge with refrigeration	0082020191	0082020263	0082020273
Multipurpose Centrifuge 592x	0082020191	0082020264	0082020274
High-Speed Centrifuge	0082029211	0082029251	N/A
Micro-Ultracentrifuge	0082029210	0082029250	N/A
Ultracentrifuge	0082029210	0082029250	N/A
Vacuum Concentrator	0082020212	0082020265	0082020275
Mastercycler®	0082040131	0082040260	N/A
ULT Freezer	0082070071	0082070260	0082070270
CO ₂ Incubator	0082060071	0082060260	0082060270
S41i Incubator Shaker	0082050021	0082050260	0082050270
Open Air Shaker	0082080091	0082080260	0082080270
Shaker with Heating	0082080121	0082080261	0082080271
Shaker with Heating/Cooling	0082080151	0082080262	0082080272
Shaker S44i	0082080231	0082080264	0082080274
Eppendorf BioPhotometer®	0082110081	0082110260	N/A
Eppendorf BioSpectrometer®	0082110111	0082110261	N/A
Temperature control & mixing instruments ¹⁾	0082100061	0082100260	N/A
VisioNize®	0082160001		

¹⁾ Eppendorf ThermoMixer®/Eppendorf ThermoStat, MixMate®

Info: Our service offers may differ by country. Please contact your local service representative for more information.

Rotor Inspection Services for Microcentrifuges and Multipurpose Centrifuges Ordering Information	
Fixed-angle rotors	5424860109
Swing-bucket rotors	5810860113
Temperature Verification Services Ordering Information	
Eppendorf ThermoMixer®/Eppendorf ThermoStat/MixMate®	0082100025
Eppendorf ThermoMixer®/Eppendorf ThermoStat/MixMate® - ISO 17025	0082100026
Eppendorf ThermoMixer®/Eppendorf ThermoStat/MixMate® - multi-channel	0082100023
Eppendorf ThermoMixer®/Eppendorf ThermoStat/MixMate® - multi-channel - ISO 17025	0082100024
Mastercycler® - sequential	6321897000
Mastercycler® - ISO 17025 - sequential	0082040027
Mastercycler® - parallel	6321897507
Mastercycler® - ISO 17025 - parallel	0082040030
Eppendorf BioSpectrometer® kinetic	6136005004
Other Verification Services Ordering Information	
Photometer Test for Eppendorf BioPhotometer®	6132005026
Photometer Test for Eppendorf BioSpectrometer®	6135005027
Photometer Test for Eppendorf BioSpectrometer® fluorescence	6137005008



Bioprocess Service



Bioprocess Performance Plans

Bioprocess systems include several sophisticated technologies. Peak performance requires smooth interplay of the subsystems and fully functioning consumable parts. Regular maintenance by qualified engineers helps to ensure reliable operation, while deferring it can cause unreliable results, expensive repairs, and prolonged downtime. Eppendorf Bioprocess Performance Plans help you to maintain the optimal performance of your equipment over years of frequent use.

Download the
bioprocess catalog



www.eppendorf.link/catalog

You will find details and ordering information for all Bioprocess Performance Plans in the Bioprocess Catalog!



EU-IVD Centrifuges



Are the tools in your lab compliant to the IVD legislation? Do they need to be?

To support regulatory compliance, Eppendorf offers two versions of our benchtop centrifuges:

An IVDR compliant, CE marked version for diagnostic applications (according to the EU In Vitro Diagnostic Regulation (IVDR) 2017/746), and a General Lab Product version for research applications.

Choosing the right version for your laboratory is easy

If your lab work is predominantly a clinical or diagnostic application IVDR compliant products can add peace of mind to support your documentation and accreditation requirements. Eppendorf has taken all measures needed to make sure the IVDR compliant documentation is fulfilled and furthermore CE certificates are provided.

If your lab work is rather research oriented, no matter if it is basic research or teaching or all the way up to pharmacological research and development, the General Lab Product version is the right choice. It comes with a large variety of research application examples and testimonials.

Quality promise of Eppendorf

Both versions follow the same extremely high quality standards at Eppendorf. We are not making any compromises in precision, accuracy, robustness, safety and ergonomics. By giving you, our customer, the choice we provide you with dedicated products for clinical purposes which have been specifically intended for that end and are not made for other applications from an unrelated field. We want you to concentrate on your work, for the better of mankind, and enable you to take care of necessary IVDR compliant documentation.

Learn more about
the Eppendorf
centrifuge portfolio!



[www.eppendorf.link/
IVDCentrifugation](http://www.eppendorf.link/IVDCentrifugation)



MiniSpin®/MiniSpin® plus



CE*

* The MiniSpin®/MiniSpin® plus is a non-automatic centrifuge for the separation of liquid substance mixtures from the human body and is specifically intended to be used as an accessory together with an in vitro diagnostic device and to enable its use according to its intended purpose. This product complies with the requirements of the EU In Vitro Diagnostics Regulation (IVDR) 2017/746.

Ordering information

Description	Order no.
Centrifuge MiniSpin® (EU-IVD) , keypad, non-refrigerated, with Rotor F-45-12-11, 230 V/50 – 60 Hz (GB)	5452000069
Centrifuge MiniSpin® plus (EU-IVD) , keypad, non-refrigerated, with Rotor F-45-12-11, 230 V/50 – 60 Hz (GB)	5453000062
Rotor F-45-12-11 , angle 45°, 12 places, max. tube diameter 11 mm, incl. rotor lid and rotor nut, MiniSpin®/MiniSpin® plus	5452720008
Rotor F-55-16-5 PCR , angle 55°, 16 places, max. tube diameter 5 mm, incl. rotor lid (aluminum), MiniSpin®/MiniSpin® plus	5452727007
Adapter , for 1 PCR tube (0.2 mL, max. Ø 6 mm), for all 1.5/2.0 mL rotors, 6 pcs.	5425715005
Adapter , for 1 sample tube (0.5 mL, max. Ø 8 mm) or 1 Microtainer® (0.6 mL, max. Ø 8 mm), for all 1.5/2.0 mL rotors, 6 pcs.	5425716001
Adapter , for 1 micro test tube (0.4 mL, max. Ø 6 mm), for all 1.5/2.0 mL rotors, 6 pcs.	5425717008

✎ Ordering information for other voltage options can be found in the “Voltage Version” chapter.

Centrifuge 5418 R



CE*

* The Centrifuge 5418 R is a non-automatic centrifuge for the separation of liquid substance mixtures from the human body and is specifically intended to be used as an accessory together with an in vitro diagnostic device and to enable its use according to its intended purpose. This product complies with the requirements of the EU In Vitro Diagnostics Regulation (IVDR) 2017/746.

Ordering information

Description	Order no.
Centrifuge 5418 R (EU-IVD) , rotary knobs, refrigerated, with Rotor FA-45-18-11 and rotor lid, 230 V/50 – 60 Hz (GB)	5401000064
Adapter , for 1 PCR tube (0.2 mL, max. Ø 6 mm), for all 1.5/2.0 mL rotors, 6 pcs.	5425715005
Adapter , for 1 sample tube (0.5 mL, max. Ø 8 mm) or 1 Microtainer® (0.6 mL, max. Ø 8 mm), for all 1.5/2.0 mL rotors, 6 pcs.	5425716001
Adapter , for 1 micro test tube (0.4 mL, max. Ø 6 mm), for all 1.5/2.0 mL rotors, 6 pcs.	5425717008

✎ Ordering information for other voltage options can be found in the “Voltage Version” chapter.

Centrifuge 5420



CE*

* The Centrifuge 5420 is a non-automatic centrifuge for the separation of liquid substance mixtures from the human body and is specifically intended to be used as an accessory together with an in vitro diagnostic device and to enable its use according to its intended purpose. This product complies with the requirements of the EU In Vitro Diagnostics Regulation (IVDR) 2017/746.

Ordering information

Description	Order no.
Centrifuge 5420 (EU-IVD) , keypad, non-refrigerated, without rotor, 230 V/50 – 60 Hz (GB)	5420000261
Centrifuge 5420 (EU-IVD) , keypad, non-refrigerated, with aerosol-tight Rotor FA-24x2, 230 V/50 – 60 Hz (GB)	5420000067

✎ Ordering information for other voltage options can be found in the “Voltage Version” chapter.



Centrifuges and Rotors

Centrifuge 5425/5425 R



* The Centrifuge 5425/5425 R is a non-automatic centrifuge for the separation of liquid substance mixtures from the human body and is specifically intended to be used as an accessory together with an in vitro diagnostic device and to enable its use according to its intended purpose. This product complies with the requirements of the EU In Vitro Diagnostics Regulation (IVDR) 2017/746.

Ordering information

Description	Order no.
Centrifuge 5425 (EU-IVD), keypad, non-refrigerated, without rotor, 230 V/50 – 60 Hz (GB)	5405000263
Centrifuge 5425 (EU-IVD), rotary knobs, non-refrigerated, without rotor, 230 V/50 – 60 Hz (GB)	5405000662
Centrifuge 5425 (EU-IVD), keypad, non-refrigerated, with Rotor FA-24x2, 230 V/50 – 60 Hz (GB)	5405000069
Centrifuge 5425 (EU-IVD), rotary knobs, non-refrigerated, with Rotor FA-24x2, 230 V/50 – 60 Hz (GB)	5405000468
Centrifuge 5425 R (EU-IVD), keypad, refrigerated, without rotor, 230 V/50 – 60 Hz (GB)	5406000267
Centrifuge 5425 R (EU-IVD), rotary knobs, refrigerated, without rotor, 230 V/50 – 60 Hz (GB)	5406000666
Centrifuge 5425 R (EU-IVD), keypad, refrigerated, with Rotor FA-24x2, 230 V/50 – 60 Hz (GB)	5406000062
Centrifuge 5425 R (EU-IVD), rotary knobs, refrigerated, with Rotor FA-24x2, 230 V/50 – 60 Hz (GB)	5406000461

✍ Ordering information for other voltage options can be found in the “Voltage Version” chapter.

Centrifuge 5427 R

New



CE*



* The Centrifuge 5427 R is a non-automatic centrifuge for the separation of liquid substance mixtures from the human body and is specifically intended to be used as an accessory together with an in vitro diagnostic device and to enable its use according to its intended purpose. This product complies with the requirements of the EU In Vitro Diagnostics Regulation (IVDR) 2017/746.

Ordering information

Description

Centrifuge 5427 R (EU-IVD), rotary knobs, refrigerated, without rotor, 230 V/50 – 60 Hz (GB)

Centrifuge 5427 R (EU-IVD), rotary knobs, refrigerated, with Rotor FA-45-30-11, 230 V/50 – 60 Hz (GB)

Centrifuge 5427 R (EU-IVD), rotary knobs, refrigerated, with Rotor FA-45-48-11, 230 V/50 – 60 Hz (GB)

Order no.

[542900065](#)

[5429000365](#)

[5429000265](#)

✎ Ordering information for other voltage options can be found in the "Voltage Version" chapter.



Your local distributor: www.eppendorf.link/contact

Eppendorf UK Limited · Gateway 1000 · Whittle Way · Stevenage SG1 2FP · United Kingdom · sales@eppendorf.co.uk · www.eppendorf.com · www.eppendorf.link/eshop

Centrifuges and Rotors

Centrifuge 5430/5430 R



* The Centrifuge 5430/5430 R is a non-automatic centrifuge for the separation of liquid substance mixtures from the human body and is specifically intended to be used as an accessory together with an in vitro diagnostic device and to enable its use according to its intended purpose. This product complies with the requirements of the EU In Vitro Diagnostics Regulation (IVDR) 2017/746.

Ordering information

Description	Order no.
Centrifuge 5430 (EU-IVD), keypad, non-refrigerated, without rotor, 230 V/50 – 60 Hz (GB)	5427000062
Centrifuge 5430 (EU-IVD), rotary knobs, non-refrigerated, without rotor, 230 V/50 – 60 Hz (GB)	5427000666
Centrifuge 5430 (EU-IVD), keypad, non-refrigerated, with Rotor FA-45-30-11 incl. rotor lid, 230 V/50 – 60 Hz (GB)	5427000267
Centrifuge 5430 (EU-IVD), rotary knobs, non-refrigerated, with Rotor FA-45-30-11 incl. rotor lid, 230 V/50 – 60 Hz (GB)	5427000461
Centrifuge 5430 R (EU-IVD), keypad, refrigerated, without rotor, 230 V/50 – 60 Hz (GB)	5428000260
Centrifuge 5430 R (EU-IVD), rotary knobs, refrigerated, without rotor, 230 V/50 – 60 Hz (GB)	5428000660
Centrifuge 5430 R (EU-IVD), keypad, refrigerated, with Rotor FA-45-30-11 incl. rotor lid, 230 V/50 – 60 Hz (GB)	5428000066
Centrifuge 5430 R (EU-IVD), rotary knobs, refrigerated, with Rotor FA-45-30-11 incl. rotor lid, 230 V/50 – 60 Hz (GB)	5428000465

✎ Ordering information for other voltage options can be found in the “Voltage Version” chapter.

Centrifuge 5702/5702 R/5702 RH



* The Centrifuge 5702/5702 R/5702 RH is a non-automatic centrifuge for the separation of liquid substance mixtures from the human body and is specifically intended to be used as an accessory together with an in vitro diagnostic device and to enable its use according to its intended purpose. This product complies with the requirements of the EU In Vitro Diagnostics Regulation (IVDR) 2017/746.

Ordering information

Description	Order no.
Centrifuge 5702 (EU-IVD) , rotary knobs, non-refrigerated, without rotor, 230 V/50 – 60 Hz (GB)	5702000060
Centrifuge 5702 (EU-IVD) , rotary knobs, non-refrigerated, with Rotor A-4-38 incl. adapters for 15/50 mL conical tubes, 2 sets of 2 adapters, 230 V/50 – 60 Hz (GB)	5702000361
Centrifuge 5702 R (EU-IVD) , rotary knobs, refrigerated, without rotor, 230 V/50 – 60 Hz (GB)	5703000063
Centrifuge 5702 R (EU-IVD) , rotary knobs, refrigerated, with Rotor A-4-38 incl. adapters for 13/16 mm blood collection tubes, 2 sets of 2 adapters, 230 V/50 – 60 Hz (GB)	5703000365
Centrifuge 5702 R (EU-IVD) , rotary knobs, refrigerated, with Rotor A-4-38 incl. adapters for 15/50 mL conical tubes, 2 sets of 2 adapters, 230 V/50 – 60 Hz (GB)	5703000462
Centrifuge 5702 RH (EU-IVD) , rotary knobs, refrigerated/heated, without rotor, 230 V/50 – 60 Hz (GB)	5704000067
Centrifuge 5702 (EU-IVD) , rotary knobs, non-refrigerated, with Rotor A-4-38 incl. adapters for round-bottom tubes 4 – 10 mL and adapters for round-bottom tubes 2.6 – 7 mL, 2 sets of 2 adapters, 230 V/50 – 60 Hz (GB)	5702000558

✎ Ordering information for other voltage options can be found in the “Voltage Version” chapter.



Centrifuges and Rotors

Centrifuge 5804/5804 R and 5810/5810 R



* The Centrifuge 5804/5804 R and 5810/5810 R is a non-automatic centrifuge for the separation of liquid substance mixtures from the human body and is specifically intended to be used as an accessory together with an in vitro diagnostic device and to enable its use according to its intended purpose. This product complies with the requirements of the EU In Vitro Diagnostics Regulation (IVDR) 2017/746.

Ordering information

Description	Order no.
Centrifuge 5804 (EU-IVD) , keypad, non-refrigerated, without rotor, 230 V/50 – 60 Hz (GB)	5804000064
Centrifuge 5804 R (EU-IVD) , keypad, refrigerated, without rotor, 230 V/50 – 60 Hz (GB)	5805000068
Centrifuge 5810 (EU-IVD) , keypad, non-refrigerated, without rotor, 230 V/50 – 60 Hz (GB)	5810000068
Centrifuge 5810 R (EU-IVD) , keypad, refrigerated, without rotor, 230 V/50 – 60 Hz (GB)	5811000061

✓ Ordering information for other voltage options can be found in the “Voltage Version” chapter.

Centrifuge Packages 58xx Family

Ordering information

Description	Conical tubes	Order no.
Centrifuge 5804 (EU-IVD) , keypad, non-refrigerated, with Rotor A-4-44 incl. adapters for 15/50 mL conical tubes, 230 V/50 – 60 Hz (GB)	16 × 15 mL/4 × 50 mL	5804000366
Centrifuge 5804 R (EU-IVD) , keypad, refrigerated, with Rotor A-4-44 incl. adapters for 15/50 mL conical tubes, 230 V/50 – 60 Hz (GB)	16 × 15 mL/4 × 50 mL	5805000360
Centrifuge 5804 (EU-IVD) , keypad, non-refrigerated, with Rotor S-4-72 incl. adapters for 15/50 mL conical tubes, 230 V/50 – 60 Hz (GB)	32 × 15 mL/16 × 50 mL	5804000560
Centrifuge 5804 R (EU-IVD) , keypad, refrigerated, with Rotor S-4-72 incl. adapters for 15/50 mL conical tubes, 230 V/50 – 60 Hz (GB)	32 × 15 mL/16 × 50 mL	5805000661
Centrifuge 5810 (EU-IVD) , keypad, non-refrigerated, with Rotor A-4-62 incl. adapters for 15/50 mL conical tubes, 230 V/50 – 60 Hz (GB)	36 × 15 mL/16 × 50 mL	5810000360
Centrifuge 5810 R (EU-IVD) , keypad, refrigerated, with Rotor A-4-62 incl. adapters for 15/50 mL conical tubes, 230 V/50 – 60 Hz (GB)	36 × 15 mL/16 × 50 mL	5811000363
Centrifuge 5810 (EU-IVD) , keypad, non-refrigerated, with Rotor A-4-81 incl. adapters for 15/50 mL conical tubes, 230 V/50 – 60 Hz (GB)	48 × 15 mL/20 × 50 mL	5810000467
Centrifuge 5810 R (EU-IVD) , keypad, refrigerated, with Rotor A-4-81 incl. adapters for 15/50 mL conical tubes, 230 V/50 – 60 Hz (GB)	48 × 15 mL/20 × 50 mL	5811000460
Centrifuge 5810 (EU-IVD) , keypad, non-refrigerated, with Rotor S-4-104 incl. adapters for 15/50 mL conical tubes, 230 V/50 – 60 Hz (GB)	56 × 15 mL/28 × 50 mL	5810000564
Centrifuge 5810 R (EU-IVD) , keypad, refrigerated, with Rotor S-4-104 incl. adapters for 15/50 mL conical tubes, 230 V/50 – 60 Hz (GB)	56 × 15 mL/28 × 50 mL	5811000665
Centrifuge 5810 (EU-IVD) , keypad, non-refrigerated, with Rotor S-4-104 incl. adapters for 13/16 mm round-bottom tubes, 230 V/50 – 60 Hz (GB)	56 × 15 mL/28 × 50 mL 92 × 13 mm/80 × 16 mm	5810000661
Centrifuge 5810 R (EU-IVD) , keypad, refrigerated, with Rotor S-4-104 incl. adapters for 13/16 mm round-bottom tubes, 230 V/50 – 60 Hz (GB)	56 × 15 mL/28 × 50 mL 92 × 13 mm/80 × 16 mm	5811000860

✓ Ordering information for other voltage options can be found in the “Voltage Version” chapter.

Centrifuge 5910 Ri



CE*

* The Centrifuge 5910 Ri is a non-automatic centrifuge for the separation of liquid substance mixtures from the human body and is specifically intended to be used as an accessory together with an in vitro diagnostic device and to enable its use according to its intended purpose. This product complies with the requirements of the EU In Vitro Diagnostics Regulation (IVDR) 2017/746.

Ordering information

Description	Order no.
Centrifuge 5910 Ri (EU-IVD) , touch interface, refrigerated, without rotor, 230 V/50 – 60 Hz (GB)	5943000068

✎ Ordering information for other voltage options can be found in the “Voltage Version” chapter.

Centrifuge Packages 5910 Ri

Ordering information

Description	Conical tubes	Order no.
Centrifuge 5910 Ri (EU-IVD) , touch interface, refrigerated, with Rotor S-4x750, incl. round buckets and adapters for 5 mL/15 mL/50 mL conical tubes, 230 V/50 – 60 Hz (GB)	56 × 15 mL/28 × 50 mL	5943000564
Centrifuge 5910 Ri (EU-IVD) , touch interface, refrigerated, with Rotor S-4xUniversal, incl. universal buckets and adapters for 5 mL/15 mL/50 mL conical tubes and plates, 230 V/50 – 60 Hz (GB)	68 × 15 mL/36 × 50 mL	5943000368
Centrifuge 5910 Ri (EU-IVD) , touch interface, refrigerated, with Rotor S-4xUniversal, incl. universal buckets and adapters for 5 mL/15 mL/50 mL conical tubes, 175 – 250 mL bottles and plates, 230 V/50 – 60 Hz (GB)	68 × 15 mL/28 × 50 mL	5943000262

✎ Ordering information for other voltage options can be found in the “Voltage Version” chapter.



Centrifuges and Rotors

Centrifuge 5920 R



CE*

* The Centrifuge 5920 R is a non-automatic centrifuge for the separation of liquid substance mixtures from the human body and is specifically intended to be used as an accessory together with an in vitro diagnostic device and to enable its use according to its intended purpose. This product complies with the requirements of the EU In Vitro Diagnostics Regulation (IVDR) 2017/746.

Ordering information

Description	Order no.
Centrifuge 5920 R (EU-IVD) , keypad, refrigerated, without rotor, 230 V/50 – 60 Hz (GB)	594800069

✎ Ordering information for other voltage options can be found in the “Voltage Version” chapter.

Centrifuge Packages 5920 R

Ordering information

Description	Conical tubes	Order no.
Centrifuge 5920 R (EU-IVD) , keypad, refrigerated, with Rotor S-4x1000, incl. high-capacity buckets and adapters for 15 mL/50 mL conical tubes, 230 V/50 – 60 Hz (GB)	108 × 15 mL/52 × 50 mL	5948000263
Centrifuge 5920 R (EU-IVD) , keypad, refrigerated, with Rotor S-4xUniversal-Large, incl. universal buckets and adapters for 5 mL/15 mL/25 mL/50 mL conical tubes and plates, 230 V/50 – 60 Hz (GB)	96 × 15 mL/40 × 50 mL	5948000965
Centrifuge 5920 R (EU-IVD) , keypad, refrigerated, with Rotor S-4x1000, incl. plate/tube buckets and adapters for 15 mL/50 mL conical tubes, 230 V/50 – 60 Hz (GB)	88 × 15 mL/40 × 50 mL	5948000468
Centrifuge 5920 R (EU-IVD) , keypad, refrigerated, with Rotor S-4x1000, incl. round buckets and adapters for 15 mL/50 mL conical tubes, 230 V/50 – 60 Hz (GB)	56 × 15 mL/28 × 50 mL	5948000360
Centrifuge 5920 R (EU-IVD) , keypad, refrigerated, with Rotor S-4xUniversal-Large, incl. universal buckets and adapters for round-bottom tubes with diameter 13/16 mm, 230 V/50 – 60 Hz (GB)	108 × 15 mL/52 × 50 mL 196 × 13 mm/148 × 16 mm	5948000867

✎ Ordering information for other voltage options can be found in the “Voltage Version” chapter.

Order Numbers for Different Mains Voltage Versions



The following products are available in the listed mains voltage versions. For mains voltage versions for which no separate order number is listed, the valid order numbers are also those listed in the first column or in

the product description. The versions marked n.a. are not available. Order-related production is marked with *.

Automated Pipetting

Power supply	Europe	UK/HKG	Australia	China	Japan	Argentina	ROW
epMotion® 96	5069 000 012	5069 000 020	5069 000 039	5069 000 047	5069 000 004	5069 000 055	5069 000 004
epMotion® 96 with 2-position slider	5069 000 110	5069 000 128	5069 000 136	5069 000 144	5069 000 101	5069 000 152	5069 000 101
epMotion® 96xl	5069 000 217	5069 000 225	5069 000 233	5069 000 241	5069 000 209	5069 000 250	5069 000 209
epMotion® 96xl with 2-position slider	5069 000 314	5069 000 322	5069 000 330	5069 000 349	5069 000 306	5069 000 357	5069 000 306

Temperature Control and Mixing

Power supply	Europe	UK/HKG	Australia	China	Japan	Argentina	ROW
Eppendorf ThermoMixer® C, basic device without thermoblock	5382 000 015	5382 000 031	5382 000 066	5382 000 074	5382 000 023	5382 000 082	5382 000 023
Eppendorf ThermoMixer® F0.5, with thermoblock for 24 reaction vessels 0.5 mL	5386 000 010	5386 000 036	5386 000 060	5386 000 079	5386 000 028	5386 000 087	5386 000 028
Eppendorf ThermoMixer® F1.5, with thermoblock for 24 reaction vessels 1.5 mL	5384 000 012	5384 000 039	5384 000 063	5384 000 071	5384 000 020	5384 000 080	5384 000 020
Eppendorf ThermoMixer® F2.0, with thermoblock for 24 reaction vessels 2.0 mL	5387 000 013	5387 000 030	5387 000 064	5387 000 072	5387 000 021	5387 000 080	5387 000 021
Eppendorf ThermoMixer® FP, with thermoblock for Microplates and Deepwell Plates, including lid	5385 000 016	5385 000 032	5385 000 067	5385 000 075	5385 000 024	5385 000 083	5385 000 024
Eppendorf ThermoStat C, basic device without thermoblock	5383 000 019	5383 000 035	5383 000 060	5383 000 078	5383 000 027	5383 000 086	5383 000 027
MixMate®, basic device without tube holders	5353 000 510	5353 000 537	5353 000 545	5353 000 553	5353 000 529	5353 000 561	5353 000 022

Centrifuges and Rotors - General Lab Products

Power supply	Europe	UK/HKG	Australia	China	Japan	Argentina	ROW
Centrifuge MiniSpin® plus, non-refrigerated, with Rotor F-45-12-11	5453 000 015	5453 000 060	5453 000 089	5453 000 097	5453 000 038	5453 000 054	n.a.
Centrifuge MiniSpin®, non-refrigerated, with Rotor F-45-12-11	5452 000 010	5452 000 060	5452 000 085	5452 000 093	5452 000 034	5452 000 050	5452 000 816
Centrifuge 5418 R, refrigerated, with Rotor FA-45-18-11 and rotor lid	5401 000 010	5401 000 060	5401 000 080	5401 000 099	5401 000 030	5401 000 056	5401 000 021
Centrifuge 5420, keypad, non-refrigerated, without rotor	5420 000 318	5420 000 369	5420 000 288	5420 000 296	5420 000 237	5420 000 253	5420 000 229
Centrifuge 5420, keypad, non-refrigerated, with aerosol-tight Rotor FA-24x2	5420 000 113	5420 000 164	5420 000 083	5420 000 091	5420 000 032	5420 000 059	5420 000 024
Centrifuge 5425, keypad, non-refrigerated, without rotor	5405 000 310	5405 000 360	5405 000 280	5405 000 298	n.a.	5405 000 255	5405 000 220
Centrifuge 5425, rotary knobs, non-refrigerated, without rotor	5405 000 719	5405 000 760	5405 000 689	5405 000 697	5405 000 638	5405 000 654	5405 000 620
Centrifuge 5425, keypad, non-refrigerated, with Rotor FA-24x2	5405 000 115	5405 000 166	5405 000 085	5405 000 093	n.a.	5405 000 050	5405 000 026
Centrifuge 5425, rotary knobs, non-refrigerated, with Rotor FA-24x2	5405 000 514	5405 000 565	5405 000 484	5405 000 492	5405 000 433	5405 000 450	5405 000 425
Centrifuge 5425, rotary knobs, non-refrigerated, Molecular Biology Solution, with Rotor FA-18x2-Kit	5405 000 174	5405 000 182	5405 000 190	5405 000 204	n.a.		n.a.
Centrifuge 5425 R, keypad, refrigerated, without rotor	5406 000 313	5406 000 364	5406 000 283	5406 000 291		5406 000 259	5406 000 224
Centrifuge 5425 R, rotary knobs, refrigerated, without rotor	5406 000 712	5406 000 763	5406 000 682	5406 000 690	5406 000 631	5406 000 658	5406 000 623
Centrifuge 5425 R, keypad, refrigerated, with Rotor FA-24x2	5406 000 119	5406 000 160	5406 000 089	5406 000 097		5406 000 054	5406 000 020
Centrifuge 5425 R, rotary knobs, refrigerated, with Rotor FA-24x2	5406 000 518	5406 000 569	5406 000 488	5406 000 496	5406 000 437	5406 000 453	5406 000 429
Centrifuge 5427 R, rotary knobs, refrigerated, without rotor	5429 000 010	5429 000 060	5429 000 083	5429 000 097	5429 000 037	5429 000 053	5429 000 027
Centrifuge 5427 R, rotary knobs, refrigerated, with Rotor FA-45-30-11	5429 000 310	5429 000 360	5429 000 383	5429 000 397	5429 000 333	5429 000 353	5429 000 327
Centrifuge 5427 R, rotary knobs, refrigerated, with Rotor FA-45-48-11	5429 000 210	5429 000 260	5429 000 283	5429 000 297	5429 000 233	5429 000 253	5429 000 227
Centrifuge 5430, keypad, non-refrigerated, without rotor	5427 000 015	5427 000 060	5427 000 089	5427 000 097	5427 000 038	5427 000 054	5427 000 020
Centrifuge 5430, rotary knobs, non-refrigerated, without rotor	5427 000 610	5427 000 660	5427 000 682	5427 000 690	5427 000 631	5427 000 658	5427 000 623
Centrifuge 5430, keypad, non-refrigerated, with Rotor FA-45-30-11 incl. rotor lid	5427 000 210	5427 000 260	5427 000 283	5427 000 291	5427 000 232	5427 000 259	5427 000 224
Centrifuge 5430, rotary knobs, non-refrigerated, with Rotor FA-45-30-11 incl. rotor lid	5427 000 415	5427 000 465	5427 000 488	5427 000 496	5427 000 437	5427 000 453	5427 000 429
Centrifuge 5430, rotary knobs, non-refrigerated, Low-Throughput Plate Solution, with Rotor A-2-MTP	5427 000 178	5427 000 186	5427 000 194	5427 000 178	5427 000 275	n.a.	n.a.
Centrifuge 5430 R, keypad, refrigerated, without rotor	5428 000 205	5428 000 255	5428 000 287	5428 000 295		5428 000 252	5428 000 228
Centrifuge 5430 R, rotary knobs, refrigerated, without rotor	5428 000 610	5428 000 655	5428 000 686	5428 000 694	5428 000 635	5428 000 651	5428 000 627
Centrifuge 5430 R, keypad, refrigerated, with Rotor FA-45-30-11 incl. rotor lid	5428 000 010	5428 000 060	5428 000 082	5428 000 090		5428 000 058	5428 000 023
Centrifuge 5430 R, rotary knobs, refrigerated, with Rotor FA-45-30-11 incl. rotor lid	5428 000 410	5428 000 460	5428 000 481	5428 000 490	5428 000 430	5428 000 457	5428 000 422
Centrifuge 5702, rotary knobs, non-refrigerated, without rotor	5702 000 010	5702 000 065	5702 000 086	5702 000 094	5702 000 043	5702 000 051	5702 000 817
Centrifuge 5702, rotary knobs, with Rotor A-4-38 incl. adapters for 15/50 mL conical tubes, 2 sets of 2 adapters	5702 000 320	5702 000 365	5702 000 388	5702 000 396	n.a.	5702 000 353	5702 000 345
Centrifuge 5702 R, rotary knobs, refrigerated, without rotor	5703 000 010	5703 000 060	5703 000 080	5703 000 098	5703 000 039	5703 000 055	5703 000 047
Centrifuge 5702 R, rotary knobs, refrigerated, with Rotor A-4-38 incl. adapters for 13/16 mm blood collection tubes, 2 sets of 2 adapters	5703 000 320	5703 000 360	5703 000 381	5703 000 390	n.a.	5703 000 357	5703 000 349
Centrifuge 5702 R, rotary knobs, refrigerated, with Rotor A-4-38 incl. adapters for 15/50 mL conical tubes, 2 sets of 2 adapters	5703 000 425	5703 000 460	5703 000 489	5703 000 497	5703 000 411	5703 000 454	5703 000 470
Centrifuge 5702 RH, rotary knobs, refrigerated/heated, without rotor	5704 000 010	5704 000 060	5704 000 083	5704 000 091	5704 000 032	5704 000 059	5704 000 040
Centrifuge 5702, rotary knobs, non-refrigerated, with Rotor A-4-38 incl. adapters for round-bottom tubes 4 – 10 mL and adapters for round-bottom tubes 2.6 – 7 mL, 2 sets of 2 adapters	5702 000 515		5702 000 566	5702 000 574	5702 000 590	5702 000 540	5702 000 582

Centrifuges and Rotors - General Lab Products

Power supply	Europe	UK/HKG	Australia	China	Japan	Argentina	ROW
Centrifuge 5804, keypad, without rotor	5804 000 010	5804 000 060	5804 000 080	5804 000 099	5804 000 048	5804 000 056	5804 000 170
Centrifuge 5804 R, keypad, refrigerated, without rotor	5805 000 010	5805 000 060	5805 000 084	5805 000 092	*	5805 000 050	*
Centrifuge 5804, keypad, with Rotor A-4-44 incl. adapters for 15/50 mL conical tubes	5804 000 320	5804 000 360	5804 000 382	5804 000 390	*	5804 000 358	5804 000 374
Centrifuge 5804, keypad, with Rotor S-4-72 incl. adapters for 15/50 mL conical tubes	5804 000 520	5804 000 565	5804 000 587	5804 000 595	*	5804 000 552	5804 000 544
Centrifuge 5804 R, keypad, refrigerated, with Rotor A-4-44 incl. adapters for 15/50 mL conical tubes	5805 000 320	5805 000 365	5805 000 386	5805 000 394	*	5805 000 351	5805 000 378
Centrifuge 5804 R, keypad, refrigerated, with Rotor S-4-72 incl. adapters for 15/50 mL conical tubes	5805 000 620	5805 000 665	5805 000 688	5805 000 696	*	5805 000 653	5805 000 645
Centrifuge 5810, keypad, non-refrigerated, without rotor	5810 000 010	5810 000 060	5810 000 084	5810 000 092	*	5810 000 050	5805 000 181
Centrifuge 5810 R, keypad, refrigerated, without rotor	5811 000 015	5811 000 065	5811 000 088	5811 000 096	*	5811 000 053	5811 000 231
Centrifuge 5810 R, keypad, refrigerated, with Rotor A-4-62 incl. adapters for 15/50 mL conical tubes	5811 000 325	5811 000 360	5811 000 380	5811 000 398	*	5811 000 355	5811 000 371
Centrifuge 5810, keypad, non-refrigerated, with Rotor A-4-81 incl. adapters for 15/50 mL conical tubes	5810 000 420	5810 000 460	5810 000 483	5810 000 491	*	5810 000 459	5810 000 475
Centrifuge 5810 R, keypad, refrigerated, with Rotor A-4-81 incl. adapters for 15/50 mL conical tubes	5811 000 420	5811 000 465	5811 000 487	5811 000 495	*	5811 000 452	5811 000 479
Centrifuge 5810, keypad, non-refrigerated, Classic Cell Culture Solution, with Rotor S-4-104 including 4 adapters for 5/15 mL tubes and 4 adapters for 50 mL conical tubes	5810 000 525	5810 000 560	5810 000 580	5810 000 599	*	5810 000 556	5810 000 548
Centrifuge 5810 R, keypad, refrigerated, with Rotor S-4-104 incl. adapters for 15/50 mL conical tubes	5811 000 620	5811 000 660	5811 000 681	5811 000 690	*	5811 000 657	5811 000 649
Centrifuge 5810, keypad, non-refrigerated, with Rotor S-4-104 incl. adapters for 13/16 mm round-bottom tubes	5810 000 620	5810 000 665	5810 000 688	5810 000 696	*	5810 000 653	5810 000 670
Centrifuge 5810 R, keypad, refrigerated, with Rotor S-4-104 incl. adapters for 13/16 mm round-bottom tubes	5811 000 820	5811 000 865	5811 000 886	5811 000 894	*	5811 000 851	5811 000 843
Centrifuge 5810, keypad, non-refrigerated, with Rotor A-4-62 incl. adapters for 15/50 mL conical tubes	5810 000 320	5810 000 365	5810 000 386	5810 000 394	*	5810 000 351	5810 000 378
Centrifuge 5910 Ri, refrigerated, without rotor	5943 000 011	5943 000 061	5943 000 084	5943 000 092	5943 000 033	5943 000 058	5943 000 025
Centrifuge 5910 Ri, refrigerated, with Rotor FA-6x50	5943 000 149	5943 000 157	5943 000 165	5943 000 203			
Centrifuge 5910 Ri, refrigerated, with Rotor S-4x750, incl. round buckets and adapters for 5 mL/15 mL/50 mL conical tubes	5943 000 516	5943 000 561	5943 000 581	5943 000 599	5943 000 538	5943 000 554	5943 000 521
Centrifuge 5910 Ri, refrigerated, with Rotor S-4xUniversal, incl. universal buckets and adapters for 5 mL/15 mL/50 mL conical tubes and plates	5943 000 316	5943 000 361	5943 000 386	5943 000 394	5943 000 335	5943 000 351	5943 000 327
Centrifuge 5910 Ri, refrigerated, with Rotor S-4xUniversal, incl. universal buckets and adapters for 5 mL/15 mL/50 mL conical tubes, 175 – 250 mL bottles and plates	5943 000 216	5943 000 266	5943 000 289	5943 000 297	5943 000 238	5943 000 254	5943 000 228
Centrifuge 5910 Ri, refrigerated, with Rotor S-4xUniversal, incl. universal buckets, adapters for 175 - 250 mL and 1000 mL bottles and 1000 mL bottles	5943 000 173	5943 000 181	5943 000 198	5943 000 301			
Centrifuge 5910 Ri, refrigerated, with Rotor S-4xUniversal, incl. universal buckets, adapters for 5 mL/15 mL/50 mL conical tubes and plates, adapters for 1000 mL bottles and 1000 mL bottles	5943 000 904	5943 000 912	5943 000 921	5943 000 939	5943 000 947		
Centrifuge 5920 R, refrigerated, without rotor	5948 000 010	5948 000 060	5948 000 085	5948 000 093	5948 000 026	5948 000 050	5948 000 026
Centrifuge 5920 R, refrigerated, with Rotor S-4xUniversal-Large	5948 000 910	5948 000 960	5948 000 980	5948 000 999	5948 000 921	5948 000 956	5948 000 921
Centrifuge 5920 R, keypad, refrigerated, with Rotor S-4xUniversal-Large, incl. universal buckets and adapters for 5 mL/15 mL/25 mL/50 mL conical tubes and plates	5948 000 911	5948 000 961	5948 000 981	5948 000 998		5948 000 957	5948 000 922
Centrifuge 5920 R, keypad, refrigerated, with Rotor S-4xUniversal-Large, incl. universal buckets and adapters for round-bottom tubes with diameter 13/16 mm	5948 000 810	5948 000 860	5948 000 883	5948 000 891		5948 000 859	5948 000 824
Centrifuge 5920 R, keypad, refrigerated, with Rotor S-4x1000, incl. high-capacity buckets and adapters for 15 mL/50 mL conical tubes	5948 000 210	5948 000 260	5948 000 280	5948 000 298	5948 000 220	5948 000 255	5948 000 220
Centrifuge 5920 R, keypad, refrigerated, with Rotor S-4x1000, incl. plate/tube buckets and adapters for 15 mL/50 mL conical tubes	5948 000 410	5948 000 460	5948 000 484	5948 000 492	5948 000 425	5948 000 450	5948 000 425
Centrifuge 5920 R, keypad, refrigerated, with Rotor S-4x1000, incl. round buckets and adapters for 15 mL/50 mL conical tubes	5948 000 315	5948 000 365	5948 000 387	5948 000 395	5948 000 328	5948 000 352	5948 000 328
Centrifuge 5920 R, keypad, refrigerated, High-Throughput Screening Solution, with Rotor S-4x1000, incl. plate/tube bucket and plate carrier	5948 000 174	5948 000 182	5948 000 190	5948 000 204			

Centrifuges and Rotors - General Lab Products

Power supply	Europe	UK/HKG	Australia	China	Japan	Argentina	ROW
Concentrator plus basic device, w/o pump, with Rotor F-45-48-11	5305 000 100	5305 000 169	5305 000 185	5305 000 193	5305 000 142	5305 000 150	5305 000 177
Concentrator plus complete system, with integrated diaphragm vacuum pump, with Rotor F-45-48-11	5305 000 304	5305 000 363	5305 000 380	5305 000 398	5305 000 347	5305 000 355	5305 000 371
Concentrator plus complete system, with integrated diaphragm vacuum pump, without rotor	5305 000 509	5305 000 568	5305 000 584	5305 000 592	5305 000 541	5305 000 550	5305 000 576
Concentrator plus complete system, with integrated diaphragm vacuum pump, with connection, e.g., for a gel dryer, without rotor	5305 000 703	5305 000 762	5305 000 589	5305 000 797	5305 000 746	5305 000 754	5305 000 770

Power supply	230V Variant, no plug*	208V Variant, NEMA 6-30P plug	220V Variant, no plug*	200V Variant, no plug*
Example regions and countries	EU and India	USA	Australia, New Zealand, SEA, China	Japan
High-Speed Centrifuge CR22N	5721 220 012	5721 220 013	5721 220 011	5721 220 000
CR22N Harvesting Bundle (4 x 1.5 L), refrigerated, High-Speed Centrifuge CR22N incl. rotor R9A2 and 4 x 1.5 L triangular bottles	5721 261 412	5721 261 413	5721 261 411	-
High-Speed Centrifuge CR30NX, refrigerated	5721 300 012	5721 300 013	5721 300 011	5721 300 010
CR30NX Harvesting Bundle (4 x 1.5 L), refrigerated, High-Speed Centrifuge CR30NX incl. rotor R9A2 and 4 x 1.5 L triangular bottles	5721 351 512	5721 351 513	5721 351 511	-
Centrifuge CP100NX, refrigerated, touch interface	5720 110 012	5720 110 013	5720 110 011	5720 110 010
Centrifuge CP90NX, refrigerated, touch interface	5720 109 012	5720 109 013	5720 109 011	5720 109 010
Centrifuge CP80NX, refrigerated, touch interface	5720 108 012	5720 108 013	5720 108 011	5720 100 810

Power supply	230V Variant*	120V Variant, NEMA 5-15 plug	220V Variant*	100V Variant*
Example regions and countries	EU and India	USA	Australia, New Zealand, SEA, China	Japan
Centrifuge CS150FNX, refrigerated, floorstanding, touch interface	5720 121 511	5720 121 513	5720 121 501	5720 121 500
Centrifuge CS150NX, refrigerated, benchtop, touch interface	5720 131 511	5720 131 513	5720 131 501	5720 131 500

* Inquire with our service experts to install your fitting plug

PCR

Power supply	Europe	UK/HKG	Australia	China	Japan	Argentina	ROW
Mastercycler® X40	6381 000 018	6381 000 042	6381 000 069	6381 000 077	6381 000 018	6381 000 085	n.a.
Mastercycler® nexus GX2	6336 000 015	6336 000 040	6336 000 066	6336 000 074	n.a.	6336 000 082	6336 000 023
Mastercycler® nexus GX2e	6338 000 012	6338 000 047	6338 000 063	6338 000 071	n.a.	6338 000 080	6338 000 020
Mastercycler® nexus X2	6337 000 019	6337 000 043	6337 000 060	6337 000 078	6337 000 027	6337 000 086	n.a.
Mastercycler® nexus X2e	6339 000 016	6339 000 040	6339 000 067	6339 000 075	n.a.	6339 000 083	6339 000 024
Mastercycler® X50s	6311 000 010	6311 000 045	6311 000 061	6311 000 070	n.a.	6311 000 088	n.a.
Mastercycler® X50a	6313 000 018	6313 000 042	6313 000 069	6313 000 077	n.a.	6313 000 085	n.a.
Mastercycler® X50h	6316 000 019	6316 000 043	6316 000 060	6316 000 078	n.a.	6316 000 086	n.a.
Mastercycler® X50i	6301 000 012	6301 000 047	6301 000 063	6301 000 071	n.a.	6301 000 080	n.a.
Mastercycler® X50l	6303 000 010	6303 000 044	6303 000 060	6303 000 079	n.a.	6303 000 087	n.a.
Mastercycler® X50t	6306 000 010	6306 000 045	6306 000 061	6306 000 070	n.a.	6306 000 088	n.a.
HeatSealer S100, incl. PCR Plate Adapter	5391 000 001	5391 000 036	5391 000 044	5391 000 060	n.a.	5391 000 079	5391 000 010
HeatSealer S200, incl. PCR Plate Adapter	5392 000 005	5392 000 030	5392 000 048	5392 000 064	n.a.	5392 000 072	5392 000 013

Freezers

Power supply	Europe/UK	Australia	China	115 V, 60 Hz	USA	Japan
CryoCube® F570n, 570 L, classic interface, green cooling liquids, air cooling, handle left side, 5 shelves	F571300031	F571300033	F571300034	F571200035	F571400035	
CryoCube® F570h, 570 L, classic interface, VIP, green cooling liquids, air cooling, handle left side, 5 shelves	F571340031	F571340033	F571340034	F571240035		
CryoCube® F570hw, 570 L, classic interface, VIP, green cooling liquids, water cooling, handle left side, 5 shelves	F571340131	F571340133	F571340134			
Innova® U535, 535 L, classic interface, VIP, classic cooling liquids, air cooling, handle left side, 3 shelves	U9430-0001	U535310003	U535310004	U9430-0000	U9430-0002	
CryoCube® F440h, 440 L, classic interface, VIP, green cooling liquids, air cooling, handle left side, 5 shelves	F440340031	F440340033	F440340034	F440240035		
CryoCube® F440n, 440 L, classic interface, green cooling liquids, air cooling, handle left side, 5 shelves	F440300031	F440300033	F440300034	F440200035	F440400035	
Innova® U360, ULT freezer, with LED interface, classic cooling liquids, and air-cooling	U9425-0001	U360310003	U360310004	U9425-0000		
CryoCube® FC660h, ULT chest freezer, with LED interface, green cooling liquids, and air-cooling	F660320001	F660320003	F660320004		F660420005 ¹⁾	
CO ₂ back-up system, for Innova® U101, U360, U535, U725/ -G, C585, C760, CryoCube® F101h and F740 series	U9043-0004			U9043-0002		F652999005
LN ₂ back-up system, for Innova® U101, U360, U535, U725/ -G, C585, C760, CryoCube® F101h and F740 series	U9044-0004			U9044-0002		F652999006
CO ₂ back-up system, for CryoCube® F440/ F570/ FC660 series, Premium U410, HEF® U410	U9043-0008			U9043-0006		
LN ₂ back-up system, for CryoCube® F440/ F570/ FC660 series, Premium U410, HEF® U410	U9044-0008			U9044-0006		

¹⁾ classic cooling in USA

Power supply	Europe	UK/HKG	Australia	China	USA	Japan
CryoCube® F101h, 101 L, classic interface, VIP, green cooling liquids, air cooling, handle right side, 2 shelves	F101340061	F101340062	F101340063	F101340064	F101240065	-
CryoCube® F740h, 3 c., 740 L, ULT freezer, with LED interface, green cooling liquids, and air-cooling, handle left side, 3 shelves	F740340011	F740340012	F740340013	F740340014	F740540015	F740040016
CryoCube® F740h, 3 c., 740 L, ULT freezer, with LED interface, green cooling liquids, and air-cooling, handle right side, 3 shelves	F740340021	F740340022	F740340023	F740340024	F740540025	F740040026
CryoCube® F740h, 5 c., 740 L, ULT freezer, with LED interface, green cooling liquids, and air-cooling, handle left side, 5 shelves	F740340031	F740340032	F740340033	F740340034	F740540035	F740400036
CryoCube® F740h, 5 c., 740 L, ULT freezer, with LED interface, green cooling liquids, and air-cooling, handle right side, 5 shelves	F740340041	F740340042	F740340043	F740340044	F740540045	F740040046
CryoCube® F740hi, 5 c., 740 L, ULT freezer, with touchscreen interface, green cooling liquids, and air-cooling, handle left side, 5 shelves	F740320031	F740320032	F740320033	F740320034	F740520035	F740020036
CryoCube® F740hi, 5 c., 740 L, ULT freezer, with touchscreen interface, green cooling liquids, and air-cooling, handle right side, 5 shelves	F740320041	F740320042	F740320043	F740320044	F740520045	F740020046
CryoCube® F740hi, 3 c., 740 L, ULT freezer, with touchscreen interface, green cooling liquids, and air-cooling, handle left side, 3 shelves	F740320011	F740320012	F740320013	F740320014	F740520015	F740020016
CryoCube® F740hi, 3 c., 740 L, ULT freezer, with touchscreen interface, green cooling liquids, and air-cooling, handle right side, 3 shelves	F740320021	F740320022	F740320023	F740320024	F740520025	F740020026
CryoCube® F740hiw, 5 c., 740 L, ULT freezer, with touchscreen interface, green cooling liquids, and water-cooling, handle left side, 5 shelves	F740320131	F740320132	F740320133	F740320134	F74052013	F740020136
CryoCube® F740hiw, 3 c., 740 L, ULT freezer, with touchscreen interface, green cooling liquids, and water-cooling, handle left side, 3 shelves	F740320111	F740320112	F740320113	F740320114	F740520115	F740020116

CO₂ Incubators

CellXpert® C170i Ordering Information

Device Options					Order no				
Door Segments	Door Handle	O ₂ Control	Humidity Monitor/ Water Level Sensor		230 V, 50/60 Hz	230 V, 50/60 Hz	230 V, 50/60 Hz	230 V, 50/60 Hz	100–120 V, 50/60 Hz
			Water Level Sensor	Copper	European	UK/HKG	Australia	China	USA/Japan
1	Right				6731 000 011*	6731 000 012*	6731 000 013*	6731 000 014*	6731 010 015*
1	Right			Yes	6731 000 511	6731 000 512	6731 000 513	6731 000 514	6731 010 515
1	Right		Humidity monitor		6731 000 111*	6731 000 112*	6731 000 113*	6731 000 114*	6731 010 115*
1	Right		Water level sensor		6731 000 211*	6731 000 212*	6731 000 213*	6731 000 214*	6731 010 215*
1	Right		Both		6731 000 311*	6731 000 312*	6731 000 313*	6731 000 314*	6731 010 315*
1	Right	1–20%			6731 001 011*	6731 001 012*	6731 001 013*	6731 001 014*	6731 011 015*
1	Right	1–20%		Yes	6731 001 511	6731 001 512	6731 001 513	6731 001 514	6731 001 515
1	Right	1–20%	Both	Yes	6731 001 811	6731 001 812	6731 001 813	6731 001 814	6731 011 815
1	Left				6731 000 021*	6731 000 022*	6731 000 023*	6731 000 024*	6731 010 025*
1	Left			Yes	6731 000 521	6731 000 522	6731 000 523	6731 000 524	6731 010 525
1	Left		Humidity monitor		6731 000 121	6731 000 122	6731 000 123	6731 000 124	6731 010 125
1	Left		Water level sensor		6731 000 221	6731 000 222	6731 000 223	6731 000 224	6731 010 225
1	Left		Both		6731 000 321	6731 000 322	6731 000 323	6731 000 324	6731 010 325
1	Left	1–20%			6731 001 021*	6731 001 022*	6731 001 023*	6731 001 024*	6731 011 025*
1	Left	1–20%		Yes	6731 001 521	6731 001 522	6731 001 523	6731 001 524	6731 001 525
1	Left	1–20%	Both	Yes	6731 001 821	6731 001 822	6731 001 823	6731 001 824	6731 011 825
4	Right				6731 000 041*	6731 000 042*	6731 000 043*	6731 000 044*	6731 010 045*
4	Right		Both		6731 000 341	6731 000 342	6731 000 343	6731 000 344	6731 010 345
4	Right		Both	Yes	6731 000 841	6731 000 842	6731 000 843	6731 000 844	6731 010 845
4	Right	1–20%			6731 001 041*	6731 001 042*	6731 001 043*	6731 001 044*	6731 011 045*
4	Right	1–20%	Both		6731 001 341	6731 001 342	6731 001 343	6731 001 344	6731 011 345
4	Left				6731 000 051	6731 000 052	6731 000 053	6731 000 054	6731 010 055
4	Left		Both		6731 000 351	6731 000 352	6731 000 353	6731 000 354	6731 010 355
4	Left		Both	Yes	6731 000 851	6731 000 852	6731 000 853	6731 000 854	6731 010 855
4	Left	1–20%	Both		6731 001 351	6731 001 352	6731 001 353	6731 001 354	6731 011 355
4	Left	1–20%			6731 001 051	6731 001 052	6731 001 053	6731 001 054	6731 011 055
8	Right	1–20%			6731 001 081*	6731 001 082*	6731 001 083*	6731 001 084*	6731 011 085*
8	Left	1–20%			6731 001 091	6731 001 092	6731 001 093	6731 001 094	6731 011 095

* Stock article; all others are built-to-order

CellXpert® C170 Ordering Information

Device Options	Order no				
	230 V, 50/60 Hz	230 V, 50/60 Hz	230 V, 50/60 Hz	230 V, 50/60 Hz	100–120 V, 150/60 Hz
Door Handle	European	UK/HKG	Australia	China	USA/Japan
CellXpert® C170, non-segmented inner door, handle right side	6734 000 011	6734 000 012	6734 000 013	6734 000 014	6734 010 015
CellXpert® C170, inner door with 4 door segments, handle right side	6734 000 041	6734 000 042	6734 000 043	6734 000 044	6734 010 045

Power supply	Europe	UK/HKG	Australia	China	ROW
New Brunswick S41i	S41I230011	S41I230012	S41I230013	S41I230014	S41I120010

Lab Shakers

Power supply	230 V, 50 Hz	120 V, 60 Hz	100 V, 60 Hz	100 V, 50 Hz
New Brunswick Innova® 40, 1.9 cm (3/4 in)	M1299-0082	M1299-0080	M1299-0081	M1299-0083
New Brunswick Innova® 40, 2.5 cm (1 in)	M1299-0092	M1299-0090	M1299-0091	M1299-0093
New Brunswick Innova® 40R, 1.9 cm (3/4 in)	M1299-0086	M1299-0084	M1299-0085	M1299-0087
New Brunswick Innova® 40R, 2.5 cm (1 in)	M1299-0096	M1299-0094	M1299-0095	M1299-0097
New Brunswick Innova® 42, 1.9 cm (3/4 in)	M1335-0002	M1335-0000	M1335-0001	M1335-0003
New Brunswick Innova® 42, 2.5 cm (1 in)	M1335-0012	M1335-0010	M1335-0011	M1335-0013
New Brunswick Innova® 42R, 1.9 cm (3/4 in)	M1335-0006	M1335-0004	M1335-0005	M1335-0007
New Brunswick Innova® 42R, 2.5 cm (1 in)	M1335-0016	M1335-0014	M1335-0015	M1335-0017
New Brunswick Innova® 43, 2.5 cm (1 in)	M1320-0002	M1320-0000	M1320-0001	M1320-0003
New Brunswick Innova® 43, 5.1 cm (2 in)	M1320-0012	M1320-0010	M1320-0011	M1320-0013
New Brunswick Innova® 43R, 2.5 cm (1 in)	M1320-0006	M1320-0004	M1320-0005	M1320-0007
New Brunswick Innova® 43R, 5.1 cm (2 in)	M1320-0016	M1320-0014	M1320-0015	M1320-0017
New Brunswick Innova® 44, 2.5 cm (1 in)	M1282-0002	M1282-0000	M1282-0001	M1282-0003
New Brunswick Innova® 44, 5.1 cm (2 in)	M1282-0012	M1282-0010	M1282-0011	M1282-0013
New Brunswick Innova® 44R, 2.5 cm (1 in)	M1282-0006	M1282-0004	M1282-0005	M1282-0007
New Brunswick Innova® 44R, 5.1 cm (2 in)	M1282-0016	M1282-0014	M1282-0015	M1282-0017

Power supply	Europe	UK/HKG	Australia	China	Japan	Argentina	Brazil	ROW
Innova® S44i, 2.5 cm (1 in) orbit, orbit 2.5 cm (1 in), incubated	S44I300001	S44I300002	S44I300003	S44I300004	S44I000006	S44I300008	S44I300009	S44I200005
Innova® S44i, 2.5 cm (1 in) orbit, orbit 2.5 cm (1 in), refrigerated	S44I310001	S44I310002	S44I310003	S44I310004	S44I010006	S44I310008	S44I310009	S44I210005
Innova® S44i, 2.5 cm (1 in) orbit, orbit 2.5 cm (1 in), refrigerated, photosynthetic LED light bank	S44I311001	S44I311002	S44I311003	S44I311004		S44I311008	S44I311009	S44I211005
Innova® S44i, 5.1 cm (2 in) orbit, orbit 5.1 cm (2 in), incubated	S44I320001	S44I320002	S44I320003	S44I320004	S44I020006	S44I320008	S44I320009	S44I220005
Innova® S44i, 5.1 cm (2 in) orbit, orbit 5.1 cm (2 in), refrigerated	S44I330001	S44I330002	S44I330003	S44I330004	S44I030006	S44I330008	S44I330009	S44I230005
Innova® S44i, 5.1 cm (2 in) orbit, orbit 5.1 cm (2 in), refrigerated, photosynthetic LED light bank	S44I331001	S44I331002	S44I331003	S44I331004		S44I331008	S44I331009	S44I231005

Centrifuges and Rotors - EU-IVD Products

Power supply	Europe	UK	China ¹⁾
Centrifuge MiniSpin® plus, non-refrigerated, with Rotor F-45-12-11	5453 000 011	5452 000 069	5452 000 093
Centrifuge MiniSpin®, non-refrigerated, with Rotor F-45-12-11	5452 000 018	5453 000 062	5453 000 097
Centrifuge 5418 R, refrigerated, with Rotor FA-45-18-11 and rotor lid	5401 000 013	5401 000 064	5401 000 099
Centrifuge 5420, keypad, non-refrigerated, without rotor	5420 000 210	5420 000 261	5420 000 296
Centrifuge 5420, keypad, non-refrigerated, with aerosol-tight Rotor FA-24x2	5420 000 016	5420 000 067	5420 000 091
Centrifuge 5425, keypad, refrigerated, without rotor	5405 000 212	5405 000 263	5405 000 298
Centrifuge 5425, rotary knobs, refrigerated, without rotor	5405 000 611	5405 000 662	5405 000 697
Centrifuge 5425, keypad, refrigerated, with Rotor FA-24x2	5405 000 018	5405 000 069	5405 000 093
Centrifuge 5425, rotary knobs, refrigerated, with Rotor FA-24x2	5405 000 417	5405 000 468	5405 000 492
Centrifuge 5425, rotary knobs, non-refrigerated, Molecular Biology Solution, with Rotor FA-18x2-Kit	5405 000 158		
Centrifuge 5425 R, keypad, non-refrigerated, without rotor	5406 000 216	5406 000 267	5406 000 291
Centrifuge 5425 R, rotary knobs, non-refrigerated, without rotor	5406 000 615	5406 000 666	5406 000 690
Centrifuge 5425 R, keypad, non-refrigerated, with Rotor FA-24x2	5406 000 011	5406 000 062	5406 000 097
Centrifuge 5425 R, rotary knobs, non-refrigerated, with Rotor FA-24x2	5406 000 410	5406 000 461	5406 000 496
Centrifuge 5427R, rotary knobs, refrigerated, without rotor	5429 000 015	5429 000 065	5429 000 097
Centrifuge 5427R, rotary knobs, refrigerated, with Rotor FA-45-30-11	5429 000 315	5429 000 365	5429 000 397
Centrifuge 5427R, rotary knobs, refrigerated, with Rotor FA-45-48-11	5429 000 215	5429 000 265	5429 000 297
Centrifuge 5430 R, keypad, refrigerated, with Rotor FA-45-30-11 incl. rotor lid	5428 000 015	5428 000 066	5428 000 090
Centrifuge 5430 R, rotary knobs, refrigerated, with Rotor FA-45-30-11 incl. rotor lid	5428 000 414	5428 000 465	5428 000 490
Centrifuge 5430 R, keypad, refrigerated, without rotor	5428 000 210	5428 000 260	5428 000 295
Centrifuge 5430 R, rotary knobs, refrigerated, without rotor	5428 000 619	5428 000 660	5428 000 694
Centrifuge 5430, keypad, non-refrigerated, with Rotor FA-45-30-11 incl. rotor lid	5427 000 216	5427 000 267	5427 000 291
Centrifuge 5430, rotary knobs, non-refrigerated, with Rotor FA-45-30-11 incl. rotor lid	5427 000 410	5427 000 461	5427 000 496
Centrifuge 5430, keypad, without rotor	5427 000 011	5427 000 062	5427 000 097
Centrifuge 5430, rotary knobs, non-refrigerated, without rotor	5427 000 615	5427 000 666	5427 000 690
Centrifuge 5702, rotary knobs, with Rotor A-4-38 incl. adapters for 15/50 mL conical tubes, 2 sets of 2 adapters	5702 000 329	5702 000 361	5702 000 396
Centrifuge 5702 R, rotary knobs, refrigerated, with Rotor A-4-38 incl. adapters for 15/50 mL conical tubes, 2 sets of 2 adapters	5703 000 420	5703 000 462	5703 000 497
Centrifuge 5702 R, rotary knobs, refrigerated, with Rotor A-4-38 incl. adapters for 13/16 mm blood collection tubes, 2 sets of 2 adapters	5703 000 322	5703 000 365	5703 000 390
Centrifuge 5702 R, rotary knobs, refrigerated, without rotor	5703 000 012	5703 000 063	5703 000 098
Centrifuge 5702 RH, rotary knobs, refrigerated/heated, without rotor	5704 000 016	5704 000 067	5704 000 091
Centrifuge 5702, rotary knobs, without rotor	5702 000 019	5702 000 060	5702 000 094
Centrifuge 5702, rotary knobs, non-refrigerated, with Rotor A-4-38 incl. adapters for round-bottom tubes 4 – 10 mL and adapters for round-bottom tubes 2.6 – 7 mL, 2 sets of 2 adapters	5702 000 510	5702 000 558	5702 000 574
Centrifuge 5804, keypad, non-refrigerated, with Rotor A-4-44 incl. adapters for 15/50 mL conical tubes	5804 000 323	5804 000 366	5804 000 390
Centrifuge 5804, keypad, non-refrigerated, with Rotor S-4-72 incl. adapters for 15/50 mL conical tubes	5804 000 528	5804 000 560	5804 000 595
Centrifuge 5804 R, keypad, refrigerated, with Rotor A-4-44 incl. adapters for 15/50 mL conical tubes	5805 000 327	5805 000 360	5805 000 394
Centrifuge 5804 R, keypad, refrigerated, with Rotor S-4-72 incl. adapters for 15/50 mL conical tubes	5805 000 629	5805 000 661	5805 000 696
Centrifuge 5804 R, keypad, refrigerated, without rotor	5805 000 017	5805 000 068	5805 000 092
Centrifuge 5804, keypad, non-refrigerated, without rotor	5804 000 013	5804 000 064	5804 000 099
Centrifuge 5810, keypad, non-refrigerated, with Rotor A-4-62 incl. adapters for 15/50 mL conical tubes	5810 000 327	5810 000 360	5810 000 394
Centrifuge 5810, keypad, non-refrigerated, with Rotor A-4-81 incl. adapters for 15/50 mL conical tubes	5810 000 424	5810 000 467	5810 000 491
Centrifuge 5810, keypad, non-refrigerated, with Rotor S-4-104 incl. adapters for 15/50 mL conical tubes	5810 000 521	5810 000 564	5810 000 599
Centrifuge 5810, keypad, non-refrigerated, with Rotor S-4-104 incl. adapters for 13/16 mm round-bottom tubes	5810 000 629	5810 000 661	5810 000 696
Centrifuge 5810 R, keypad, refrigerated, with Rotor A-4-62 incl. adapters for 15/50 mL conical tubes	5811 000 320	5811 000 363	5811 000 398
Centrifuge 5810 R, keypad, refrigerated, with Rotor A-4-81 incl. adapters for 15/50 mL conical tubes	5811 000 428	5811 000 460	5811 000 495
Centrifuge 5810 R, keypad, refrigerated, with Rotor S-4-104 incl. adapters for 15/50 mL conical tubes	5811 000 622	5811 000 665	5811 000 690
Centrifuge 5810 R, keypad, refrigerated, with Rotor S-4-104 incl. adapters for 13/16 mm round-bottom tubes	5811 000 827	5811 000 860	5811 000 894
Centrifuge 5810 R, keypad, refrigerated, without rotor	5811 000 010	5811 000 061	5811 000 096
Centrifuge 5810, keypad, non-refrigerated, without rotor	5810 000 017	5810 000 068	5810 000 092
Centrifuge 5910 Ri, refrigerated, without rotor	5943 000 017	5943 000 068	5943 000 092
Centrifuge 5910 Ri, refrigerated, with Rotor S-4x750, incl. round buckets and adapters for 5 mL/15 mL/50 mL conical tubes	5943 000 511	5943 000 564	5943 000 599
Centrifuge 5910 Ri, refrigerated, with Rotor S-4xUniversal, incl. universal buckets and adapters for 5 mL/15 mL/50 mL conical tubes and plates	5943 000 319	5943 000 368	5943 000 394
Centrifuge 5910 Ri, refrigerated, with Rotor S-4xUniversal, incl. universal buckets and adapters for 5 mL/15 mL/50 mL conical tubes, 175 – 250 mL bottles and plates	5943 000 211	5943 000 262	5943 000 297
Centrifuge 5920 R, keypad, refrigerated, without rotor	5948 000 018	5948 000 069	5948 000 093
Centrifuge 5920 R, keypad, refrigerated, with Rotor S-4x1000, incl. high-capacity buckets and adapters for 15 mL/50 mL conical tubes	5948 000 212	5948 000 263	5948 000 298
Centrifuge 5920 R, keypad, refrigerated, with Rotor S-4x1000, incl. round buckets and adapters for 15 mL/50 mL conical tubes	5948 000 310	5948 000 360	5948 000 395
Centrifuge 5920 R, keypad, refrigerated, with Rotor S-4x1000, incl. plate/tube buckets and adapters for 15 mL/50 mL conical tubes	5948 000 417	5948 000 468	5948 000 492
Centrifuge 5920 R, keypad, refrigerated, with Rotor S-4xUniversal-Large, incl. universal buckets and adapters for round-bottom tubes with diameter 13/16 mm	5948 000 816	5948 000 867	5948 000 891
Centrifuge 5920 R, keypad, refrigerated, with Rotor S-4xUniversal-Large, incl. universal buckets and adapters for 5 mL/15 mL/25 mL/50 mL conical tubes and plates	5948 000 914	5948 000 965	5948 000 998

¹⁾ Listed articles (except for Centrifuge 5920 R) registered as medical devices class 1 in China.



A series of horizontal lines spanning the width of the page, providing a template for writing.

Contact:
General Enquiries 01438 735 888

Eppendorf UK Limited
Gateway 1000 · Whittle Way
Arlington Business Park
Stevenage · SG1 2FP
Phone.: +44 (0)1438 735 888
Fax: +44 (0)1438 735 889

Eppendorf Online Shop:
www.eppendorf.link/eshop

Internet & E-Mail:
www.eppendorf.co.uk
sales@eppendorf.co.uk

Application Support

UK Application Hotline:
+44 (0) 1438 735 880
support@eppendorf.com

North America:
+1 800 645 3050, menu option 2
techserv@eppendorf.com

Asia Pacific Africa:
+603 8023 6869
support_asiapacific@eppendorf.com

More information for you:

Our distributors

Your local contact



www.eppendorf.link/distributors/

Legal notices, trademarks, patent and design attributions

Trademarks of third parties may appear on this catalogue when referring to their products or services. All trademarks are the property of their respective owners. The trademark name representations and listed owners can be found here:



www.eppendorf.link/trademarks

Imprint:

Eppendorf SE
Barkhausenweg 1
22339 Hamburg
Germany
Phone: + 49 40 53 801-0
Fax: + 49 40 53 801-556

E-mail: eppendorf@eppendorf.de
or contact form
Web: www.eppendorf.com
Registration court:
Local Court Hamburg
Registration number: HRB 171526

Management Board:
Dr. Wilhelm Plüster (Spokesperson for the Management Board, Chief Technology Officer), Axel Jaeger (Member of the Management Board, Chief Financial Officer),
Dr. Dirk Eric Loebermann (Member of the Management Board, Chief Operating Officer)

Chairman of the Supervisory Board:
Philipp von Loeper

Turnover tax identification number pursuant to § 27 a Turnover Tax Law:
DE 118649726