

Register your instrument!
www.eppendorf.com/myeppendorf



HeatSealer S200

Operating manual

Copyright© 2019 Eppendorf AG, Germany. All rights reserved, including graphics and images. No part of this publication may be reproduced without the prior permission of the copyright owner.

Eppendorf® and the Eppendorf Brand Design are registered trademarks of Eppendorf AG, Germany.

Registered trademarks and protected trademarks are not marked in all cases with ® or ™ in this manual.

Table of contents

1	Operating instructions	5
1.1	Using this manual	5
1.2	Danger symbols and danger levels	5
1.2.1	Danger symbols	5
1.2.2	Danger levels	5
1.3	Symbols used	5
2	Safety	6
2.1	Intended use	6
2.2	Warnings for intended use	6
2.3	Warning signs on the device	7
2.4	User profile	7
2.5	Information on product liability	7
3	Product description	8
3.1	Delivery package	8
3.2	Features	8
3.3	Product overview	9
4	Installation	10
4.1	Preparing installation	10
4.2	Selecting the location	10
4.3	Changing the voltage	10
4.4	Connecting the device	12
5	Operation	13
5.1	Operating controls	13
5.2	Parameter settings	14
5.2.1	Setting the temperature	14
5.2.2	Setting the sealing duration	14
5.3	Sealing the plate	15
5.4	Switching the audible alert on/off	18
6	Troubleshooting	19
6.1	Thermal fuse triggered	19
6.2	The device cannot be switched on or does not heat up	19
7	Maintenance	20
7.1	Cleaning	20
7.2	Disinfection/Decontamination	21
7.3	Replacing fuses	22

8	Technical data	23
9	Transport, storage and disposal	24
9.1	Decontamination before shipment	24
9.2	Transport	24
9.3	Storage	24
9.4	Disposal	25
10	Ordering information	26
	Certificates	27

1 Operating instructions





1.1 Using this manual

- ▶ Read this operating manual completely before using the device for the first time. Also observe the instructions for use of the accessories.
- ▶ This operating manual is part of the product. Thus, it must always be easily accessible.
- ▶ Enclose this operating manual when transferring the device to third parties.
- ▶ You will find the current version of the operating manual for all available languages on our webpage under www.eppendorf.com.

1.2 Danger symbols and danger levels

1.2.1 Danger symbols

The safety instructions in this manual have the following danger symbols and danger levels:

	Hazard point		Hot surface
	Electric shock		Biohazard
	Material damage		

1.2.2 Danger levels

DANGER	<i>Will</i> lead to severe injuries or death.
WARNING	<i>May</i> lead to severe injuries or death.
CAUTION	May lead to light to moderate injuries.
NOTICE	May lead to material damage.

1.3 Symbols used

Depiction	Meaning
1.	Actions in the specified order
2.	
▶	Actions without a specified order
•	List
<i>Text</i>	Display text or software text
	Additional information

2 Safety

2.1 Intended use

The Eppendorf HeatSealer S200 is used to seal plates using suitable films and foils.

The Eppendorf HeatSealer S200 can be used in training/routine/research labs in the life sciences, industry and chemistry sectors. The device may only be used for research purposes. Eppendorf does not provide a warranty for other applications. Not suitable for use in diagnostics or therapeutics.

2.2 Warnings for intended use



WARNING! Risk of fire.

- ▶ Do not use this device to process any highly flammable liquids.



WARNING! Damage to health due to infectious liquids and pathogenic germs.

- ▶ When handling infectious liquids and pathogenic germs, observe the national regulations, the biosafety level of your laboratory, the material safety data sheets, and the manufacturer's application notes.
- ▶ Wear your personal protective equipment.
- ▶ For comprehensive regulations about handling germs or biological material of risk group II or higher, please refer to the "Laboratory Biosafety Manual" (source: World Health Organization, Laboratory Biosafety Manual, the current edition).



CAUTION! Poor safety due to incorrect accessories and spare parts.

The use of accessories and spare parts other than those recommended by Eppendorf may impair the safety, functioning and precision of the device. Eppendorf cannot be held liable or accept any liability for damage resulting from the use of accessories and spare parts other than those recommended, or from the improper use of such equipment.

- ▶ Only use accessories and original spare parts recommended by Eppendorf.



NOTICE! Damage to the device due to spilled liquid.

- ▶ Switch off the device.
- ▶ Disconnect the mains/power plug.
- ▶ Collect the spilled liquid. Observe the specifications in the safety data sheet for the liquid.



NOTICE! Material damage to the heating plate due to unsuitable plates.

Plates with elevated rims are not suitable for sealing with foils. The elevated rims may melt and damage the heating plate.

- ▶ Use plates without elevated rims only.

2.3 Warning signs on the device

Warning sign	Meaning
	<p>CAUTION! Burns from hot surfaces. The metal surfaces of the heating plate reach temperatures of up to 200 °C.</p> <ul style="list-style-type: none"> ▶ Do not touch the hot surfaces. ▶ Let the device cool down to ambient temperature before starting an inspection or repair work.
	<p>How to set the temperature range and sealing duration is described in the operating manual.</p> <ul style="list-style-type: none"> ▶ Read the operating manual.
	<p>Only use the device with the plate adapter inserted.</p>

2.4 User profile

This device may only be operated by trained and skilled personnel.

Before using the device, read the operating manual carefully and familiarize yourself with the device's mode of operation.

2.5 Information on product liability

In the following cases, the designated protection of the device may be affected. Liability for any resulting damage or personal injury is then transferred to the owner:

- The device is not used in accordance with the operating manual.
- The device is used outside of its intended use.
- The device is used with accessories or consumables that are not recommended by Eppendorf.
- The device is maintained or repaired by persons not authorized by Eppendorf AG.
- The user makes unauthorized changes to the device.

3 **Product description**
3.1 **Delivery package**

Quantity	Description
1	HeatSealer S200
1	Mains/power cord
1	Adapter for 96-well PCR plates
1	Fuse for 115 V
1	Operating manual

3.2 **Features**

The Heatsealer enables reliable and quick sealing of a multitude of plates.

The sealing duration and temperature can be set on the Heatsealer. The display shows a countdown during the sealing process.

Sealed plates protect samples against evaporation and are thus highly suitable for transporting or storing samples.

The HeatSealer S200 excels with the following features:

- Seals 96- and 384-well plates.
- Suitable for PCR and DWP plates and microplates.
- Suitable for plates of different heights and materials.
- Optimum sealing of plates using suitable films and foils through adjustable sealing temperature.
- Reproducible sealing results through adjustable sealing duration.
- An integrated thermostat prevents the device from overheating.

3.3 Product overview

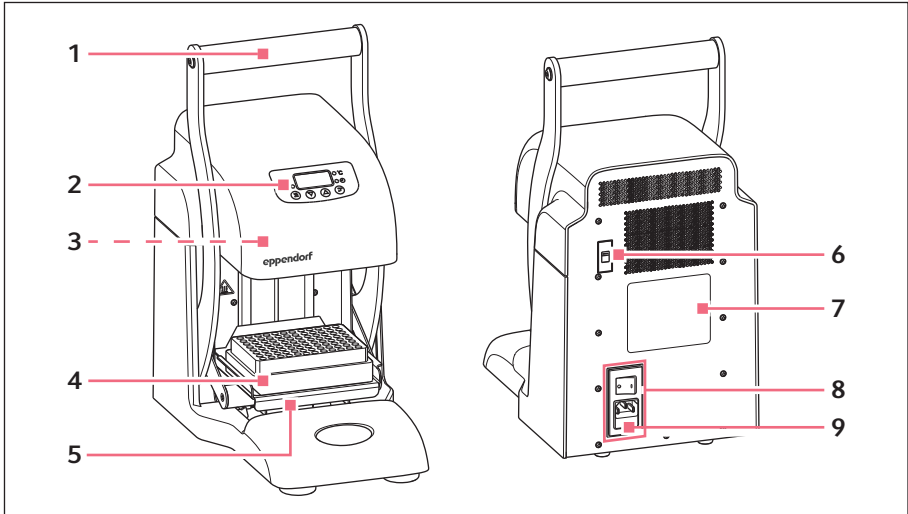

- 1 Handle
- 2 Control panel
- 3 Heating plate
- 4 Plate adapter
- 5 Adapter holder

- 6 Selector switch for mains/power supply voltage
- 7 Name plate
- 8 Mains/power cord socket with mains/power switch
- 9 Fuse drawer

4 Installation

4.1 Preparing installation



Store the transport packaging and packing material for future safe transport or storage.

- ▶ Use the details included in the delivery package to check that the delivery is complete.
- ▶ Check all parts for any transport damage.

4.2 Selecting the location

Select the device location according to the following criteria:

- Mains/power connection in accordance with the name plate
- Minimum distance to other devices and walls: 10 cm
- Resonance free table with horizontal even work surface
- The design of table is suitable for operating the device.
- Surrounding area must be well ventilated.
- The location must be protected against direct sunlight.



The mains/power switch and the disconnecting device of the mains/power line must be easily accessible during operation (e.g. a residual current circuit breaker).

4.3 Changing the voltage



DANGER! Electric shock.

- ▶ Switch off the device and disconnect the mains/power plug before commencing any service or cleaning operations.



NOTICE! Damage to device due to a fuse that does not match the preselected mains/power supply voltage.

- ▶ Use a fuse that matches the preselected mains/power supply voltage in accordance with the table.

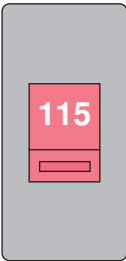
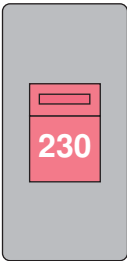

The device is delivered with a fuse for 230 V.
If the device is to be converted for a mains/power supply voltage of 115 V, replace the fuse in accordance with the table.

Setting the mains/power supply voltage on the device		
Voltage supply	110 – 120 V ±10 %	220 – 230 V ±10 %
Fuse	T3, 15 AH 250 V 20x5 mm	T1, 6 AH 250 V 20x5 mm

The mains/power supply voltage selector switch is located at the rear of the device.

- i** The mains/power cord socket with the mains/power switch is protected by a safety sticker upon delivery only.

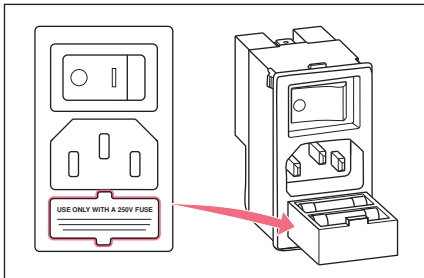

1. Remove the safety sticker.
2. Set the mains/power supply voltage using the selector switch.
3. Open the fuse drawer using a suitable screwdriver and pull it out completely.
4. Remove the fuse and, if applicable, the spare fuse from the fuse drawer.
5. Insert a fuse suitable for the selected mains/power voltage in the rear compartment.
6. Close the fuse drawer again.

4.4 Connecting the device



WARNING! Danger due to incorrect voltage supply.

- ▶ Only connect the device to voltage sources which correspond with the electrical requirements on the name plate.
- ▶ Only use earth/grounded sockets with a protective earth (PE) conductor.
- ▶ Only use the mains/power cord supplied.



WARNING! Electric shock due to damage to the device or mains/power cord.

- ▶ Only switch on the device if the device and mains/power cord are undamaged.
- ▶ Only operate devices which have been installed or repaired properly.
- ▶ In case of danger, disconnect the device from the mains/power supply voltage. Disconnect the mains/power plug from the device or the earth/grounded socket. Use the isolating device intended for this purpose (e.g. the emergency switch in the laboratory).



NOTICE! Damage to electronic components due to condensation.

Condensate may form in the device when it has been transported from a cool environment to a warmer environment.

- ▶ After installing the device, wait for at least 12 h. Only then connect the device to the mains/power line.





Prerequisites

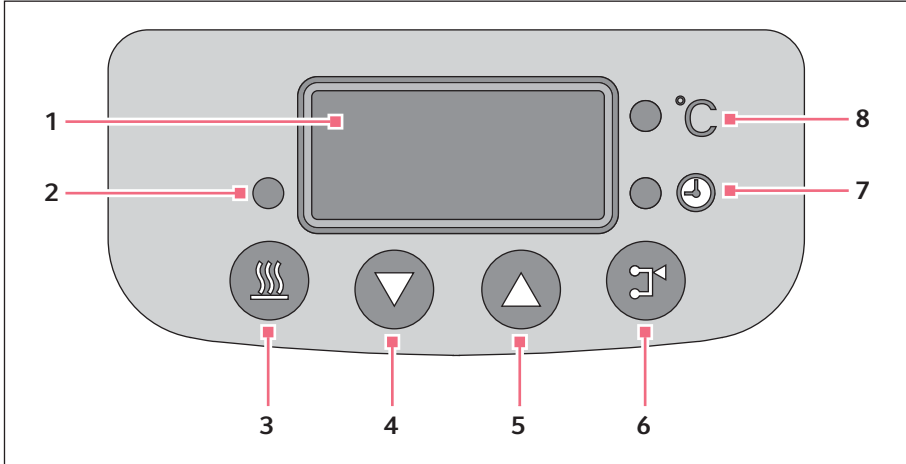

- Device is switched off.
- Electrical connection data in accordance with name plate.
- Voltage is switched on.
- Fuse matches selected voltage.
- ▶ Connect the mains/power cable included in the delivery.

5 Operation
5.1 Operating controls



- | | |
|---------------------|-------------------|
| 1 Display | 5 up key |
| 2 heater status LED | 6 mode key |
| 3 heater key | 7 time LED |
| 4 down key | 8 temperature LED |

 	<p>The heating plate is switched on/off by means of the <i>heater</i> key.</p> <ul style="list-style-type: none"> <i>heater</i> status LED does not illuminate Heating is off. <i>heater</i> status LED flashes Heating plate heats up. <i>heater</i> status LED illuminates Set temperature has been reached.
	<p>Display value is gradually reduced.</p>
	<p>Display value is gradually increased.</p>

	The <i>mode</i> key is used to switch between two modes: <ul style="list-style-type: none">• Setting the temperature• Setting the sealing duration
	<i>temperature</i> LED illuminates <i>temperature</i> mode is selected. The temperature can be set.
	<i>time</i> LED illuminates <i>time</i> mode is selected. The sealing duration can be set.

5.2 Parameter settings



The sealing duration depends on the selected combination of plate and foil. A sealing duration that is too long can damage the plate, destroy samples and reduce the sealing quality. Before sealing plates with samples, determine the optimum sealing temperature and time with an empty plate. Start with 2 s to 3 s.

5.2.1 Setting the temperature

1. Switch on the device.
2. Press the *mode* key until the *temperature* LED illuminates.
3. Use the *up* and *down* keys to set the desired temperature.
The temperature can be set from 125 °C to 200 °C in 1 °C increments.

5.2.2 Setting the sealing duration

1. Press the *mode* key until the *time* LED illuminates.
2. Use the *up* and *down* keys to set the desired sealing duration.
The sealing duration can be set from 1.0 s to 9.0 s in 0.5 s increments.

5.3 Sealing the plate



CAUTION! Crush hazard due to moving assemblies.

Risk of crushing your fingers or hands in case of improper operation.

- ▶ Do not place your fingers between the moving device components when sealing the plate.
- ▶ Do not keep hold of the foil during the sealing process.



CAUTION! Burns from hot surfaces.

The metal surfaces of the heating plate reach temperatures of up to 200 °C.

- ▶ Do not touch the hot surfaces.
- ▶ Let the device cool down to ambient temperature before starting an inspection or repair work.



NOTICE! Damage to device due to unsuitable consumables.

The metal surfaces of the heating plate reach temperatures of up to 200 °C. Consumables with a low temperature resistance can burn or melt.



- ▶ Only use consumables with a temperature resistance suitable for the sealing temperature.
- ▶ Do not exceed the optimum sealing duration.

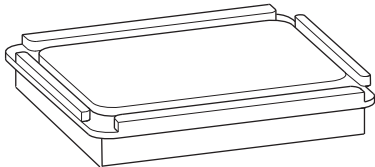

The optimum height for sealing is set by means of the adapter.

- ▶ Make sure that adapter and plate match.

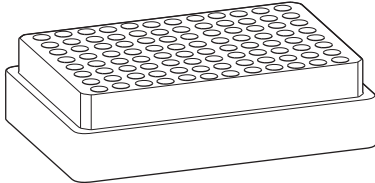
Adapter	Matching plates
<p>Plate Adapter, high profile (not included in the HeatSealer delivery package)</p> 	<p>96-well Microplates 384-well Microplates 384-well PCR Plates Deepwell Plate 384/200µL Deepwell Plate 96/500µL</p>

Adapter	Matching plates
<p data-bbox="103 256 557 288">96-well PCR Plate Adapter</p> 	<p data-bbox="557 256 1012 343">96-well PCR Plates unskirted 96-well PCR Plates semi-skirted 96-well PCR Plates skirted</p>
<p data-bbox="103 486 557 566">Plate Adapter, low profile (not included in the HeatSealer delivery package)</p> 	<p data-bbox="557 486 1012 542">Deepwell Plate 96/1000µL Deepwell Plate 96/2000µL</p>

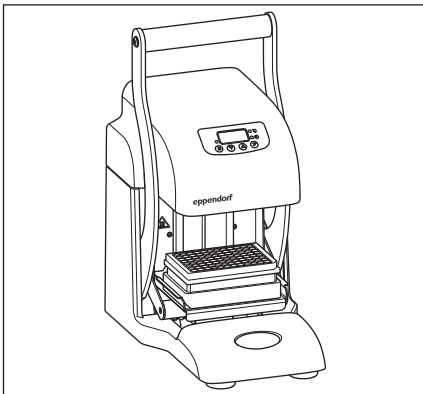

1. Switch on the device.
2. Insert adapter.
3. Set the temperature and sealing duration.
4. Press the *heater* key.
The *heater* LED flashes and the heating plate heats up. It takes approx. 10 minutes to heat up.
When it has reached the set temperature the *heater* LED illuminates constantly.
The device is ready for operation.
5. Put the plate on the adapter.

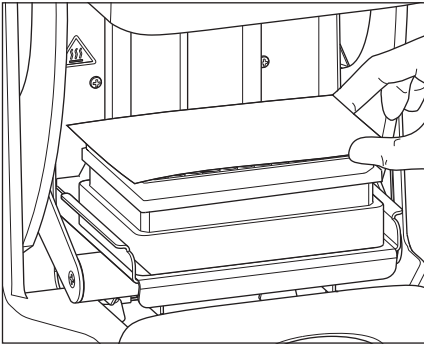

6. Position the foil on the plate. The foil must be laid with the sealing or adhesive side down on the plate.

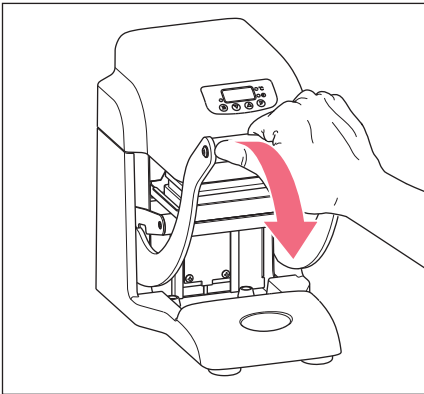

7. Press the handle down until the heating plate makes contact with the foil. Do not apply more force than is necessary. The device automatically detects when the heating plate has reached the correct position and starts the countdown for the sealing duration.
8. Hold a sufficiently strong contact between the heating plate and foil until the countdown has ended.

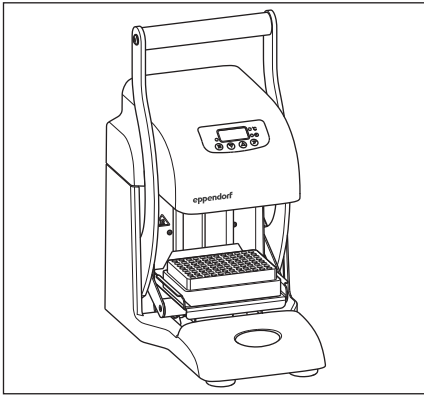

9. Shift the handle back to its starting position.
10. Let the sealed plate cool off.
11. Remove the plate.
12. If no other plates are to be sealed:
Switch off the device.

5.4 Switching the audible alert on/off

The audible alert sounds when the sealing duration countdown starts or ends.

1. Switch on the device.
2. Press the *mode* key until the *temperature* LED illuminates.
3. Press the *heater* and *mode* keys simultaneously.
The current setting of the audible alert is shown on the display.
 - 01: Alert switched on
 - 00: Alert switched off
4. Use the *up* and *down* keys to switch the alert on/off.
5. Press the *mode* key to save the setting.

6 Troubleshooting

6.1 Thermal fuse triggered

The device is equipped with a thermal fuse. When a temperature of 235 °C is exceeded on the heating plate, the thermal fuse triggers and switches the heating plate off permanently.

- ▶ Send the defective device to the authorized service center.

6.2 The device cannot be switched on or does not heat up

1. Check the mains/power plug and mains/power cord.
2. Check the set mains/power supply voltage and the fuse. Replace the fuse if it is defective.
3. Switch the device off and back on.



If none of these measures could eliminate the problem:

- ▶ Send the defective device to the authorized service center.

7 Maintenance

7.1 Cleaning

Regularly clean the housing of the device and the adapter.



DANGER! Electric shock due to the ingress of liquid.

- ▶ Switch off the device and disconnect it from the mains/power line before starting cleaning or disinfection.
 - ▶ Do not allow any liquids to penetrate the inside of the housing.
 - ▶ Do not perform a spray clean/spray disinfection on the housing.
 - ▶ Only reconnect the device to the mains/power line when it is completely dry, both inside and outside.
-



NOTICE! Damage from the use of aggressive chemicals.

- ▶ Do not use any aggressive chemicals on the device or its accessories, such as strong and weak bases, strong acids, acetone, formaldehyde, halogenated hydrocarbons or phenol.
- ▶ If the device has been contaminated by aggressive chemicals, clean it immediately using a mild cleaning agent.



NOTICE! Corrosion due to aggressive cleaning agents and disinfectants.

- ▶ Do not use any corrosive cleaning agents, aggressive solvents or abrasive polishes.



NOTICE! Improper tools can cause damage.

Removing residuals on the heating plate with tools can destroy the heating plate.

- ▶ Only use a lint-free cloth to clean the device and the heating plate.
-

Aids

- Lint-free cloth.
- Mild soap-based laboratory cleaner.
- Distilled water.

Cleaning the device

1. Switch off the device and disconnect it from the mains/power line.
2. Allow device to cool down.
3. Clean all exterior parts of the device and the adapter plate with a mild soap solution and lint-free cloth.
4. Wipe off the soap solution with distilled water.
5. Dry all cleaned parts.

7.2 Disinfection/Decontamination



DANGER! Electric shock due to the ingress of liquid.

- ▶ Switch off the device and disconnect it from the mains/power line before starting cleaning or disinfection.
 - ▶ Do not allow any liquids to penetrate the inside of the housing.
 - ▶ Do not perform a spray clean/spray disinfection on the housing.
 - ▶ Only reconnect the device to the mains/power line when it is completely dry, both inside and outside.
-

1. Switch off the device and disconnect it from the mains/power line.
2. Remove all cables and accessory parts from the device.
3. Clean the device with a mild cleaning agent before the disinfection.
4. Select a disinfection method that corresponds with the legal provisions and guidelines valid for your area of application.
 - Use e.g. alcohol (ethanol, isopropanol) or alcoholic disinfectant.
5. Wipe the surfaces with a lint-free cloth that has been moistened with disinfectant.
6. Disinfect all parts that are to be sent in with the device.

7.3 Replacing fuses



DANGER! Electric shock.

- ▶ Switch off the device and disconnect the mains/power plug before commencing any service or cleaning operations.



NOTICE! Damage to device due to a fuse that does not match the preselected mains/power supply voltage.

- ▶ Use a fuse that matches the preselected mains/power supply voltage in accordance with the table.



The device is supplied with a fuse for 230 V.

If the device is to be converted for a mains/power supply voltage of 115 V, then the fuse must be replaced according to the table.

Setting the mains/power supply voltage on the device

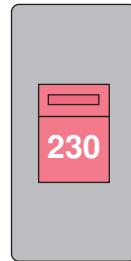
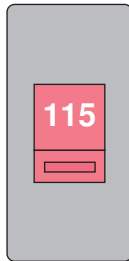

Voltage supply	110 – 120 V ± 10 %	220 – 230 V ± 10 %
Fuse	T3, 15 AH 250 V 20x5 mm	T1, 6 AH 250 V 20x5 mm

The selector switch for the mains/power supply voltage is located on the rear side of the device.

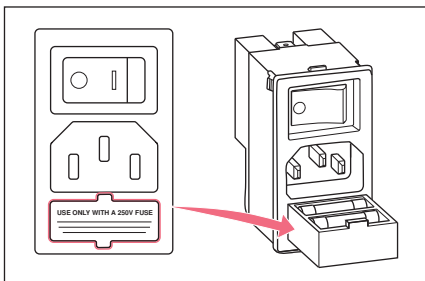

1. Switch off the device and disconnect the mains/power plug.
2. Open the fuse drawer using a suitable screwdriver and pull it right out.
3. Replace the defective fuse in the rear compartment.
4. Close the fuse drawer again.

8 Technical data

Weights and dimensions

Weight	7.2 kg
Width	220 mm
Depth	325 mm
Height	425 mm

Mains/power supply

Voltage supply 115 V	110 – 120 V ± 10 % / 50 Hz – 60 Hz ± 5 %
Voltage supply 230 V	220 – 230 V ± 10 % / 50 Hz – 60 Hz ± 5 %
Power consumption, max.	350 W
Degree of pollution	2 (IEC 664)
Protection class	I
Overvoltage category	II
Fuse 115 V	T3, 15 AH 250 V 20x5 mm
Fuse 230 V	T1, 6 AH 250 V 20x5 mm

Ambient conditions

For indoor use only

Ambient temperature	+18 °C – +35 °C
Relative humidity	20 % – 80 %
Atmospheric pressure	Can be used up to an altitude of 2200 m above MSL

Operating temperature

Adjustable temperature range	125 °C – 200 °C in increments of 1 °C
Tolerance range	± 2 °C
Adjustable sealing duration	1.0 s – 9.0 s in increments of 0.5 s

9 Transport, storage and disposal

9.1 Decontamination before shipment

If you are shipping the device to the authorized Technical Service for repairs or to your authorized dealer for disposal please note the following:



WARNING! Risk to health from contaminated device.

1. Observe the information in the decontamination certificate. It is available as a PDF document on our webpage (www.eppendorf.com/decontamination).
2. Decontaminate all the parts you are going to dispatch.
3. Include the fully completed decontamination certificate in the shipment.

9.2 Transport

- ▶ Use the original packing for transport.
- ▶ Use the transport securing devices.

	Air temperature	Relative humidity	Atmospheric pressure
General transport	-10 °C – +50 °C	20 % – 95 %	300 hPa – 1060 hPa
Air freight	-10 °C – +50 °C	20 % – 95 %	300 hPa – 1060 hPa

9.3 Storage

	Air temperature	Relative humidity	Atmospheric pressure
In transport packing	-10 °C – +50 °C	20 % – 95 %	700 hPa – 1060 hPa
Without transport packing	-10 °C – +50 °C	20 % – 95 %	700 hPa – 1060 hPa

9.4 Disposal

If the product needs to be disposed of, the relevant legal regulations must be observed.

Information on the disposal of electrical and electronic devices in the European Community:

Within the European Community, the disposal of electrical devices is regulated by national regulations based on EU Directive 2012/19/EU pertaining to waste electrical and electronic equipment (WEEE).

According to these regulations, any devices supplied after August 13, 2005, in the business-to-business sphere, to which this product is assigned, may no longer be disposed of in municipal or domestic waste. To document this, they have been marked with the following marking:



Because disposal regulations may differ from one country to another within the EU, please contact your supplier if necessary.

Ordering information

HeatSealer S200

English (EN)

10 Ordering information

Order no. (International)	Order no. (North America)	Description
5391 000.001	5391000001	HeatSealer S100 100 – 230 V/50 – 60 Hz
5392 000.005	5392000005	HeatSealer S200 100 – 230 V/50 – 60 Hz
5392 070.020	5392070020	Plate Adapter, low profile, for HeatSealer S200
5392 070.038	5392070038	96-well PCR Plate Adapter, for HeatSealer S200
5392 070.011	5392070011	Plate Adapter, high profile, for HeatSealer S200
0030 127.838	0030127838	Eppendorf Heat Sealing Film PCR clean, 100 pcs.
0030 127.854	0030127854	Eppendorf Heat Sealing Foil PCR clean, 100 pcs.

Declaration of Conformity

The product named below fulfills the requirements of directives and standards listed. In the case of unauthorized modifications to the product or an unintended use this declaration becomes invalid. This declaration of conformity is issued under the sole responsibility of the manufacturer.

Product name:

HeatSealer S200

including accessories

Product type:

Heat sealer

Relevant directives / standards:

- 2014/35/EU: EN 61010-1, EN 61010-2-010
UL 61010-1, CAN/CSA C22.2 No. 61010-1
- 2014/30/EU: EN 61326-1
47 CFR FCC part 15
- 2011/65/EU: EN 50581

Hamburg, February 04, 2019

Dr. Wilhelm Plüster
Management Board



Dr. Philip Müller
Head of Business Unit
Instrumentation & Systems

Your local distributor: www.eppendorf.com/contact
Eppendorf AG · Barkhausenweg 1 · 22339 Hamburg · Germany
eppendorf@eppendorf.com

Eppendorf* and the Eppendorf Brand Design are registered trademarks of Eppendorf AG, Germany.
All rights reserved, incl. graphics and pictures. Copyright ©2019 by Eppendorf AG.

www.eppendorf.com

ISO
9001
Certified

ISO
13485
Certified

ISO
14001
Certified

Evaluate Your Manual

Give us your feedback.
www.eppendorf.com/manualfeedback

Your local distributor: www.eppendorf.com/contact
Eppendorf AG · Barkhausenweg 1 · 22339 Hamburg · Germany
eppendorf@eppendorf.com · www.eppendorf.com