

Register your instrument!  
[www.eppendorf.com/myeppendorf](http://www.eppendorf.com/myeppendorf)



# Centrifuge 5424 R

Operating manual

Copyright ©2018 All rights reserved, including graphics and images. No part of this publication may be reproduced without the prior permission of the copyright owner.

Microtainer® is a registered trademark of Becton Dickinson, USA.

Eppendorf® and the Eppendorf Brand Design are registered trademarks of Eppendorf AG, Germany.

Eppendorf VisioNize® is a registered trademark of Eppendorf AG, Germany.

Registered trademarks and protected trademarks are not marked in all cases with ® or ™ in this manual.

U.S. Patents are listed on [www.eppendorf.com/ip](http://www.eppendorf.com/ip)

## Table of contents

<b>1</b>	<b>Operating instructions</b>	<b>5</b>
1.1	Using this manual	5
1.2	Danger symbols and danger levels	5
1.2.1	Danger symbols	5
1.2.2	Danger levels	5
1.3	Symbols used	6
1.4	Abbreviations used	6
<b>2</b>	<b>Safety</b>	<b>7</b>
2.1	Intended use	7
2.2	User profile	7
2.3	Information on product liability	7
2.4	Application limits	8
2.4.1	Declaration concerning the ATEX directive (2014/34/EU)	8
2.5	Warnings for intended use	8
2.5.1	Personal injury or damage to device	8
2.5.2	Incorrect handling of the centrifuge	10
2.5.3	Incorrect handling of the rotors	10
2.5.4	Extreme strain on the centrifugation tubes	11
2.5.5	Aerosol-tight centrifugation	12
2.6	Safety instructions on device and accessories	13
<b>3</b>	<b>Product description</b>	<b>15</b>
3.1	Product overview	15
3.2	Delivery package	16
3.3	Features	16
3.4	Name plate	17
<b>4</b>	<b>Installation</b>	<b>19</b>
4.1	Selecting the location	19
4.2	Preparing installation	20
4.3	Installing the instrument	21
<b>5</b>	<b>Operation</b>	<b>23</b>
5.1	Operating controls	23
5.2	Navigating in the menu	25
5.3	Menu structure	25
5.4	Switching on the centrifuge	27
5.5	Replacing the rotor	27
5.5.1	Inserting the rotor	27
5.5.2	Removing the rotor	27
5.6	Closing the centrifuge lid	27
5.7	Cooling	28
5.7.1	Temperature adjustment	28
5.7.2	Temperature display	28
5.7.3	Temperature monitoring	28
5.7.4	FastTemp	28
5.7.5	Continuous cooling	29

**Table of contents**Centrifuge 5424 R  
English (EN)

5.8	Centrifugation . . . . .	29
5.8.1	Centrifuging with preset time . . . . .	30
5.8.2	Centrifuging in continuous operation . . . . .	30
5.8.3	Short run centrifugation . . . . .	31
5.8.4	Removing the rotor . . . . .	31
<b>6</b>	<b>Maintenance . . . . .</b>	<b>33</b>
6.1	Service . . . . .	33
6.2	Preparing cleaning/disinfection . . . . .	33
6.3	Cleaning/disinfection . . . . .	34
6.3.1	Cleaning and disinfecting the device . . . . .	35
6.3.2	Disinfecting and cleaning the rotor . . . . .	36
6.4	Additional care instructions for refrigerated centrifuges . . . . .	36
6.5	Cleaning glass breakage . . . . .	37
6.6	Fuses . . . . .	37
6.7	Decontamination before shipment . . . . .	38
<b>7</b>	<b>Troubleshooting . . . . .</b>	<b>39</b>
7.1	General errors . . . . .	39
7.2	Error messages . . . . .	40
7.3	Emergency release . . . . .	41
<b>8</b>	<b>Transport, storage and disposal . . . . .</b>	<b>43</b>
8.1	Transport . . . . .	43
8.2	Storage . . . . .	43
8.3	Disposal . . . . .	44
<b>9</b>	<b>Technical data . . . . .</b>	<b>45</b>
9.1	Power supply . . . . .	45
9.2	Ambient conditions . . . . .	45
9.3	Weight/dimensions . . . . .	45
9.4	Noise level . . . . .	46
9.5	Application parameters . . . . .	46
9.5.1	Centrifuge 5424 R . . . . .	46
9.6	Service life for accessories . . . . .	47
9.7	Rotors . . . . .	48
9.7.1	rcf display and calculation . . . . .	49
<b>10</b>	<b>Ordering information . . . . .</b>	<b>51</b>
10.1	Accessories . . . . .	51
10.1.1	Rotors and rotor lids . . . . .	51
10.1.2	Adapter . . . . .	51
10.1.3	Other accessories . . . . .	52
10.2	Fuses . . . . .	52
	<b>Certificates . . . . .</b>	<b>53</b>

# 1 Operating instructions

## 1.1 Using this manual







- ▶ Read this operating manual completely before using the device for the first time. Observe the instructions for use of the accessories where applicable.
- ▶ This operating manual is part of the product. Please keep it in a place that is easily accessible.
- ▶ Enclose this operating manual when transferring the device to third parties.
- ▶ The current version of the operating manual for all available languages can be found on our webpage [www.eppendorf.com/manuals](http://www.eppendorf.com/manuals).

The Centrifuge 5424 R is available in two versions: **keypad** or **rotary knobs**. This operating manual generally describes how to operate the keypad version. However, it also applies to the rotary knob version.

## 1.2 Danger symbols and danger levels

### 1.2.1 Danger symbols

The safety instructions in this manual have the following danger symbols and danger levels:

	<b>Biohazard</b>		<b>Explosive substances</b>
	<b>Electric shock</b>		<b>Risk of crushing</b>
	<b>Hazard point</b>		<b>Material damage</b>

### 1.2.2 Danger levels

<b>DANGER</b>	<i>Will</i> lead to severe injuries or death.
<b>WARNING</b>	<i>May</i> lead to severe injuries or death.
<b>CAUTION</b>	<i>May</i> lead to light to moderate injuries.
<b>NOTICE</b>	<i>May</i> lead to material damage.

**Operating instructions**

Centrifuge 5424 R  
English (EN)

**1.3 Symbols used**

<b>Depiction</b>	<b>Meaning</b>
1. 2.	Actions in the specified order
▶	Actions without a specified order
•	List
<i>Text</i>	Display or software texts
<b>i</b>	Additional information

**1.4 Abbreviations used****PCR**

Polymerase Chain Reaction

**PTFE**

Polytetrafluorethylene

**rcf**

Relative centrifugal force :g-force in  $m/s^2$

**rpm**

Revolutions per minute

**UV**

Ultraviolet radiation

## **2 Safety**

### **2.1 Intended use**

The Centrifuge 5424 R is designed for separating liquid substance mixtures with different densities, in particular, for processing and analyzing samples from the human body in in-vitro diagnostic applications to ensure that the in-vitro diagnostic device can be used according to its intended purpose. This centrifuge including components is an in-vitro diagnostic device according to Directive 98/79/EC of the European Parliament and the Council dated October 27, 1998.

Eppendorf centrifuges are exclusively intended for indoor use by trained specialists.

### **2.2 User profile**

The device and accessories may only be operated by trained and skilled personnel.

Before using the device, read the operating manual carefully and familiarize yourself with the device's mode of operation.

### **2.3 Information on product liability**

In the following cases, the designated protection of the device may be affected. Liability for any resulting damage or personal injury is then transferred to the owner:

- The device is not used in accordance with the operating manual.
- The device is used outside of its intended use.
- The device is used with accessories or consumables that are not recommended by Eppendorf.
- The device is maintained or repaired by persons not authorized by Eppendorf AG.
- The user makes unauthorized changes to the device.

## 2.4 Application limits

### 2.4.1 Declaration concerning the ATEX directive (2014/34/EU)



#### **DANGER! Risk of explosion.**

- ▶ Do not operate the device in areas where explosive substances are handled.
- ▶ Do not use this device to process any explosive or highly reactive substances.
- ▶ Do not use this device to process any substances which may generate an explosive atmosphere.

Due to its design and the environmental conditions inside the device, the Centrifuge 5424 R is not suitable for use in a potentially explosive atmosphere.

The device may only be used in a safe environment, such as in the open environment of a ventilated laboratory or a fume hood. The use of substances that may contribute to a potentially explosive atmosphere is not permitted. The final decision on the risks associated with the use of such substances lies with the user.

## 2.5 Warnings for intended use

### 2.5.1 Personal injury or damage to device



#### **WARNING! Electric shock due to damage to the device or mains/power cord.**

- ▶ Only switch on the device if the device and mains/power cord are undamaged.
- ▶ Only operate devices which have been installed or repaired properly.
- ▶ In case of danger, disconnect the device from the mains/power supply voltage. Disconnect the mains/power plug from the device or the earth/grounded socket. Use the isolating device intended for this purpose (e.g. the emergency switch in the laboratory).



#### **WARNING! Lethal voltages inside the device.**

If you touching any parts which are under high voltage you may experience an electric shock. Electric shocks cause injuries to the heart and respiratory paralysis.

- ▶ Ensure that the housing is closed and undamaged.
- ▶ Do not remove the housing.
- ▶ Ensure that no liquids can penetrate the device.

Only authorized service staff may open the device.



#### **WARNING! Danger due to incorrect voltage supply.**

- ▶ Only connect the device to voltage sources which correspond with the electrical requirements on the name plate.
- ▶ Only use earth/grounded sockets with a protective earth (PE) conductor.
- ▶ Only use the mains/power cord supplied.





**WARNING! Damage to health due to infectious liquids and pathogenic germs.**

- ▶ When handling infectious liquids and pathogenic germs, observe the national regulations, the biosafety level of your laboratory, the material safety data sheets, and the manufacturer's application notes.
- ▶ Wear your personal protective equipment.
- ▶ For comprehensive regulations about handling germs or biological material of risk group II or higher, please refer to the "Laboratory Biosafety Manual" (source: World Health Organization, Laboratory Biosafety Manual, the current edition).



**WARNING! Risk of injury when opening or closing the centrifuge lid.**

There is a risk of crushing your fingers when opening or closing the centrifuge lid.

- ▶ When opening or closing the centrifuge lid, do not reach between the lid and device or into the latching mechanism of the lid.
- ▶ Always open the centrifuge lid completely to prevent it from falling.



**WARNING! Risk of injury from rotating rotor.**

If the emergency release of the lid is operated, the rotor may continue to rotate for several minutes.

- ▶ Wait for the rotor to stop before activating the emergency release.
- ▶ To check, look through the monitoring glass in the centrifuge lid.



**WARNING! Risk of injury from chemically or mechanically damaged accessories.**

Even minor scratches and cracks can lead to severe internal material damage.

- ▶ Protect all accessory parts from mechanical damage.
- ▶ Inspect the accessories for damage before every use. Replace any damaged accessories.
- ▶ Do not use rotors or rotor lids showing signs of corrosion or mechanical damage (e.g. deformations).
- ▶ Do not use any accessories which have exceeded their maximum service life.



**CAUTION! Poor safety due to incorrect accessories and spare parts.**

The use of accessories and spare parts other than those recommended by Eppendorf may impair the safety, functioning and precision of the device. Eppendorf cannot be held liable or accept any liability for damage resulting from the use of accessories and spare parts other than those recommended, or from the improper use of such equipment.

- ▶ Only use accessories and original spare parts recommended by Eppendorf.



**NOTICE! Damage to the device due to spilled liquids.**

1. Switch off the device.
2. Disconnect the device from the mains/power supply.
3. Carefully clean the device and the accessories in accordance with the cleaning and disinfection instructions in the operating manual.
4. If a different cleaning and disinfecting method is to be used, contact Eppendorf AG to ensure that the intended method will not damage the device.



**NOTICE! Damage to electronic components due to condensation.**

Condensate may form in the device when it has been transported from a cool environment to a warmer environment.

- ▶ After installing the device, wait for at least 4 h. Only then connect the device to the mains/power line.

## 2.5.2 Incorrect handling of the centrifuge



**NOTICE! Damage from knocking against or moving the device during operation.**

If the rotor hits the rotor chamber wall, it will cause considerable damage to the device and rotor.

- ▶ Do not move or knock against the device during operation.

## 2.5.3 Incorrect handling of the rotors



**WARNING! Risk of injury from improperly attached rotors and rotor lids.**

- ▶ Only centrifuge with rotor and rotor lid firmly tightened.
- ▶ If there are any unusual noises when the centrifuge is started up, the rotor or rotor lid may not be attached properly. Immediately press the **start/stop** key to stop centrifuging.



**CAUTION! Risk of injury due to asymmetrical loading of a rotor.**

- ▶ Load rotors symmetrically with identical tubes.
- ▶ Only load adapters with suitable tubes.
- ▶ Always use the same type of tubes (weight, material/density and volume).
- ▶ Check symmetric loading by balancing the adapters and tubes used with scales.



**CAUTION! Risk of injury from overloaded rotor.**

The centrifuge is designed for the centrifugation of material with a maximum density of 1.2 g/mL at maximum speed and filling volume and/or load.

- ▶ Do not exceed the maximum load of the rotor.



**NOTICE! Damage to rotors from aggressive chemicals.**

Rotors are high-quality components which withstand extreme stresses. This stability can be impaired by aggressive chemicals.

- ▶ Avoid using aggressive chemicals such as strong and weak alkalis, strong acids, solutions with mercury ions, copper ions and other heavy metal ions, halogenated hydrocarbons, concentrated saline solutions and phenol.
- ▶ If it is contaminated by aggressive chemicals, clean the rotor and especially the rotor bores immediately using a neutral cleaning agent.
- ▶ Due to the manufacturing process, color variations may occur on PTFE coated rotors. These color variations do not affect the service life or resistance to chemicals.

## 2.5.4 Extreme strain on the centrifugation tubes



**CAUTION! Risk of injury from overloaded tubes.**

- ▶ Note the loading limits specified by the tube manufacturer.
- ▶ Only use tubes which are approved by the manufacturer for the required  $g$ -force (rcf).



**NOTICE! Risk from damaged tubes.**

Damaged tubes must not be used, as this could cause further damage to the device and the accessories and loss of the samples.

- ▶ Visually check all of the tubes for damage before use.



**NOTICE! Danger from open tube lids.**

Open tube lids may break off during centrifugation and damage both the rotor and the centrifuge.

- ▶ Carefully seal all tube lids before centrifuging.



**NOTICE! Damage to plastic tubes from organic solvents.**

The density of plastic tubes is reduced when organic solvents (e.g., phenol, chloroform) are used, i.e. the tubes could become damaged.

- ▶ Note the manufacturer's information on the chemical resistance of the tubes.

---

## 2.5.5 Aerosol-tight centrifugation



**WARNING! Risk to health due to limited aerosol tightness with incorrect rotor/rotor lid combination.**

Aerosol-tight centrifugation is guaranteed only if the rotors and rotor lids intended for this purpose are used. The designation of aerosol-tight fixed-angle rotors always starts with **FA**. The aerosol-tight rotors and rotor lids of this centrifuge are additionally marked with a red ring on the rotor and a red rotor lid screw.

- ▶ Always use rotors and rotor lids marked aerosol-tight together for aerosol-tight centrifugation. The details specifying in which centrifuge you may use the aerosol-tight rotors and rotor lids can be found on the rotor and on the upper side of the rotor lid.
- ▶ Only use aerosol-tight rotor lids in combination with the rotors that are marked on the rotor lid.







**WARNING! Damage to health due to limited aerosol tightness in the event of incorrect use.**

Mechanical stresses and contamination by chemicals or other aggressive solvents may impair the aerosol tightness of the rotors and rotor lids. Autoclaving at excessive temperatures can lead to vessels, adapters and rotor lids becoming brittle and deformed.

- ▶ Check the integrity of the seals of the aerosol-tight rotor lids or caps before each use.
  - ▶ Only use aerosol-tight rotor lids or caps if the seals are undamaged and clean.
  - ▶ Do not exceed temperatures of 121°C or a time of more than 20 min. while autoclaving.
  - ▶ After each proper autoclaving process (121 °C, 20 min.), thinly brush the threads of the rotor lid screw with pivot grease (order no. Int. 5810 350.050, North America 022634330).
  - ▶ Replace aerosol-tight rotor lids without replaceable seals after 50 autoclaving cycles.
  - ▶ For QuickLock rotor lids, only the seal must be replaced after 50 autoclaving cycles.
  - ▶ **Never** store aerosol-tight rotors or buckets closed.
-

## 2.6 Safety instructions on device and accessories

Depiction	Meaning	Location
	<b>NOTICE</b> ▶ Observe the safety instructions in the operating manual.	Right side of the device
	▶ Observe operating manual.	Right side of the device
	Warning: Possible hand injury	Upper side of the device
	▶ Always tighten the rotor with the enclosed rotor key.	Upper side of the device, under the centrifuge lid
	Warning of biological risks when handling infectious liquids or pathogenic germs.	Aerosol-tight fixed-angle rotors: Rotor lid

**Safety**

Centrifuge 5424 R  
English (EN)

### 3 Product description

#### 3.1 Product overview

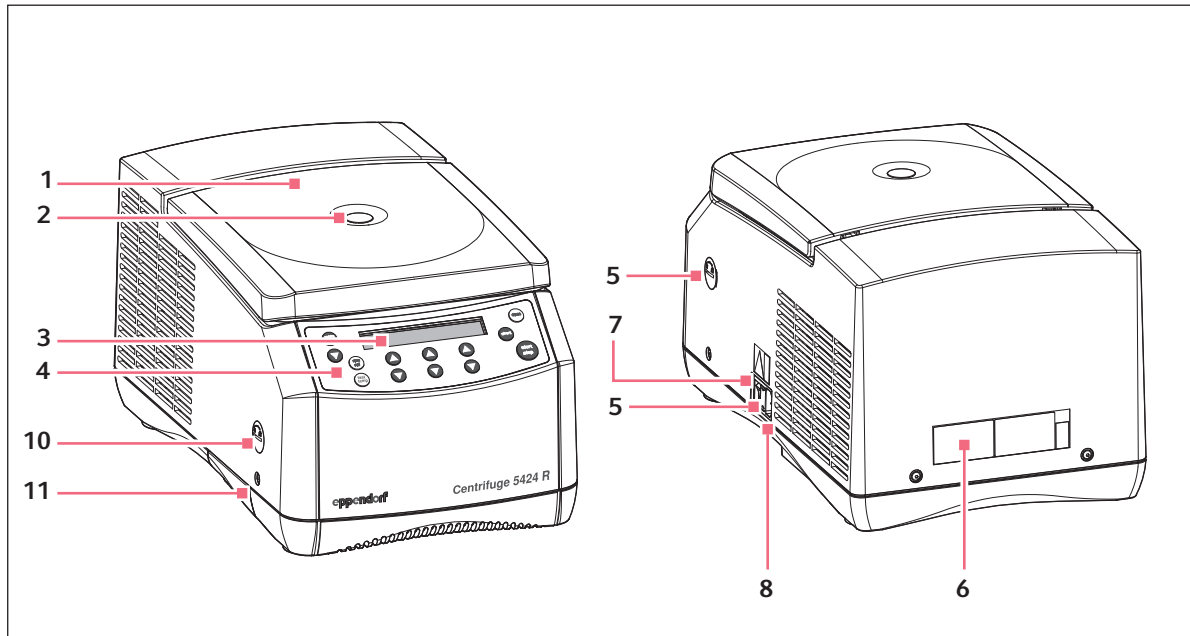

Fig. 3-1: Front and rear view of the Centrifuge 5424 R

- |   |  |
|---|--|
| <b>1 Centrifuge lid</b>   | <b>7 Mains/power switch</b><br>Switch for switching the centrifuge on and off.     |
| <b>2 Monitoring glass</b><br>Visual control for rotor stop or speed control option using stroboscope      | <b>8 Mains/power connection</b><br>Connection socket for the mains cable supplied. |
| <b>3 Display</b>  | <b>9 Fuse holder</b>   |
| <b>4 Control panel</b><br>Keys and dials (dependent on the device version) for operating the centrifuge . | <b>10 Interface for software updates</b><br>Only for authorized service personnel  |
| <b>5 Emergency release</b>  | <b>11 Condensation water tray</b>  |
| <b>6 Name plate</b>   |  |

**Product description**

Centrifuge 5424 R  
English (EN)

**3.2 Delivery package**

1	Centrifuge 5424 R
1	Rotor key
1	Mains/power cord
1	Directions
1	Condensation water tray



- ▶ Check whether the delivery is complete.
- ▶ Check all parts for any transport damage.
- ▶ To safely transport and store the device, retain the transport box and packing material.

**3.3 Features**

The versatile Centrifuge 5424 R has a capacity of 24 × 2 mL and can achieve a maximum speed of 21130 × g / 15000 rpm. You can select from different rotors to centrifuge the following tubes for various applications:

- Micro test tubes (0.2 mL to 2.0 mL)
- PCR strips
- Microtainers (0.6 ml)
- Spin columns (1.5/2.0 ml)

The Centrifuge 5424 R has an additional temperature control function for centrifugation between -10°C and +40°C. Use the **fast temp** function to start a temperature control run without samples to bring the rotor chamber incl. rotor, buckets and adapters to the set target temperature quickly.

The Centrifuge 5424 R can be connected to the Eppendorf VisioNize system. The Eppendorf VisioNize system provides the option to connect the centrifuge to centralized monitoring and data management software. For further information, please refer to the [www.eppendorf.com](http://www.eppendorf.com).



### 3.4 Name plate

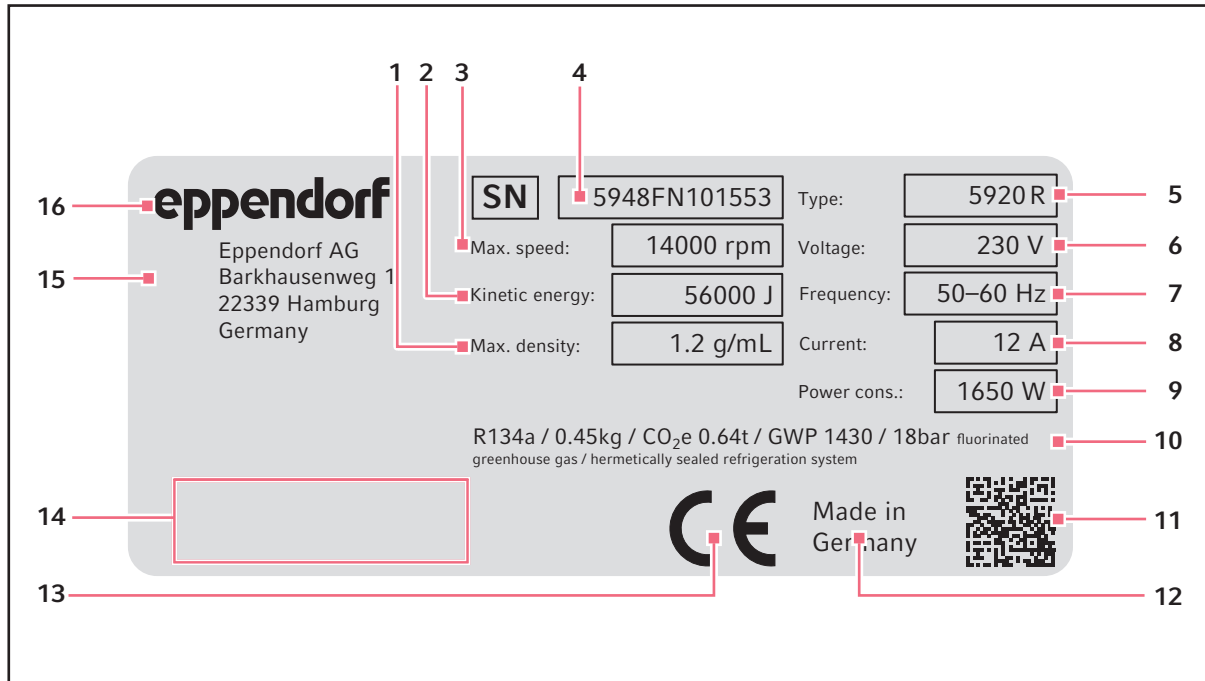









Fig. 3-2: Eppendorf AG device identification (example)

- |   |  |
|---|--|
| <b>1</b> Maximum density of the material for centrifuging | <b>9</b> Maximum rated power   |
| <b>2</b> Maximum kinetic energy                           | <b>10</b> Information on the refrigerant (refrigerated centrifuges only) |
| <b>3</b> Maximum speed                                    | <b>11</b> Data matrix code for serial number                             |
| <b>4</b> Serial number                                    | <b>12</b> Designation of origin  |
| <b>5</b> Product name                                     | <b>13</b> CE marking   |
| <b>6</b> Rated voltage                                    | <b>14</b> Certification marks and symbols (device-specific)              |
| <b>7</b> Rated frequency                                  | <b>15</b> Address of manufacturer  |
| <b>8</b> Maximum rated current                            | <b>16</b> Manufacturer   |

**Product description**

Centrifuge 5424 R  
English (EN)

Tab. 3-1: Certification marks and symbols (device-specific)

Symbol/Certification mark	Meaning
	Serial number
	Manufacturer
	In-vitro diagnostic device (Directive 98/79/EC), European Community
	Symbol for waste electrical and electronic equipment (WEEE) according to EU Directive 2012/19/EU, European Community
	UL mark: declaration of conformity, USA
	Conformity mark for electromagnetic compatibility according to the <i>Federal Communications Commission</i> , USA
	China conformity mark – Use of certain hazardous substances in electrical and electronic products ( <i>Requirements for Concentration Limits for Certain Hazardous Substances in Electronic Information Products SJ/T 11363-2006</i> ), People's Republic of China

## 4 Installation

### 4.1 Selecting the location

---



**WARNING! Danger due to incorrect voltage supply.**

- ▶ Only connect the device to voltage sources which correspond with the electrical requirements on the name plate.
  - ▶ Only use earth/grounded sockets with a protective earth (PE) conductor.
  - ▶ Only use the mains/power cord supplied.
- 



**NOTICE! If an error occurs, the objects in the immediate proximity of the device may be damaged.**

- ▶ In accordance with the recommendations of EN 61010-2-020, leave a safety clearance of **30 cm** around the device during operation.
  - ▶ Please remove all materials and objects from this area.
- 



**NOTICE! Damage due to overheating.**

- ▶ Do not install the device near heat sources (e.g. heating, drying cabinet).
  - ▶ Do not expose the device to direct sunlight.
  - ▶ Ensure unobstructed air circulation. Maintain a clearance of at least 30 cm around all ventilation gaps.
- 



**NOTICE! Radio interference.**

For devices with Class A noise emission in accordance with EN 61326-1/EN 55011, the following applies: This device has been developed and tested in accordance with CISPR 11 Class A. The device may cause radio interference in domestic environments and is not intended for use in residential areas. The device cannot ensure adequate protection of radio reception in residential areas and domestic environments.

- ▶ If necessary, take appropriate measure to eliminate the interferences.
- 



Mains/power connection for centrifuges: The operation of the centrifuge is only permitted using building installations which comply with the applicable national regulations and standards. In particular, it needs to be ensured that there are no prohibited loads on the supply lines and assemblies that are located before the internal protection of the device. This can be ensured by additional circuit breakers or other suitable fuse elements in the building installation.



The mains/power switch and the disconnecting device of the mains/power line must be easily accessible during operation (e.g. a residual current circuit breaker).

**Installation**

Centrifuge 5424 R  
English (EN)

Select the location of the device according to the following criteria:

- Mains/power connection in accordance with the name plate
  - Minimum distance to other devices and walls: 30 cm
  - Resonance free table with horizontal even work surface
  - The surrounding area must be well ventilated.
  - The location is protected against direct sunlight.
- ▶ Do not use this device near strong electromagnetic sources (e.g. unshielded high frequency sources) as they could impede proper functioning of the device.

## 4.2 Preparing installation

Prerequisites

The weight of the Centrifuge 5424 R is 21 kg. A second person is needed to unpack and position the device.

1. Open the packaging box.
2. Remove accessories.
3. Reach with your hands under the device and lift the centrifuge from the carton with another person.
4. Remove the front and back transport protection pads.
5. Place the centrifuge on a suitable lab bench.
6. Remove the plastic sleeve.

## 4.3 Installing the instrument

### Prerequisites

The device is on a suitable lab bench.



#### **WARNING! Danger due to incorrect voltage supply.**

- ▶ Only connect the device to voltage sources which correspond with the electrical requirements on the name plate.
- ▶ Only use earth/grounded sockets with a protective earth (PE) conductor.
- ▶ Only use the mains/power cord supplied.



#### **NOTICE! Damage to electronic components due to condensation.**

Condensate may form in the device when it has been transported from a cool environment to a warmer environment.

- ▶ After installing the device, wait for at least 4 h. Only then connect the device to the mains/power line.



#### **NOTICE! Compressor damage after improper transport.**

- ▶ After installation, wait 4 hh before switching on the centrifuge.
- 

1. Let the device warm up to ambient temperature.
2. Check that the mains voltage and frequency match the requirements on the device type plate.
3. Connect the centrifuge to the mains/power line and switch it on at the mains/power switch.
  - The display is active.
  - Lid opens automatically
4. **Only device version with rotor:** Turn rotor counterclockwise supplied rotor key and remove rotor towards the top in an upright movement.
5. Remove the transport protection pad.
6. Place the rotor vertically on the motor shaft.
7. Turn the rotor nut using the rotor key clockwise until the rotor nut is tightened.
8. Insert the condensation water tray into the holder provided .



## 5 Operation

### 5.1 Operating controls

The Centrifuge 5424 R is available in two versions: with keypad (arrow keys) or with rotary knobs. This operating manual describes the operation of the centrifuge with keypad. The centrifuge with rotary knobs is operated in the same manner.

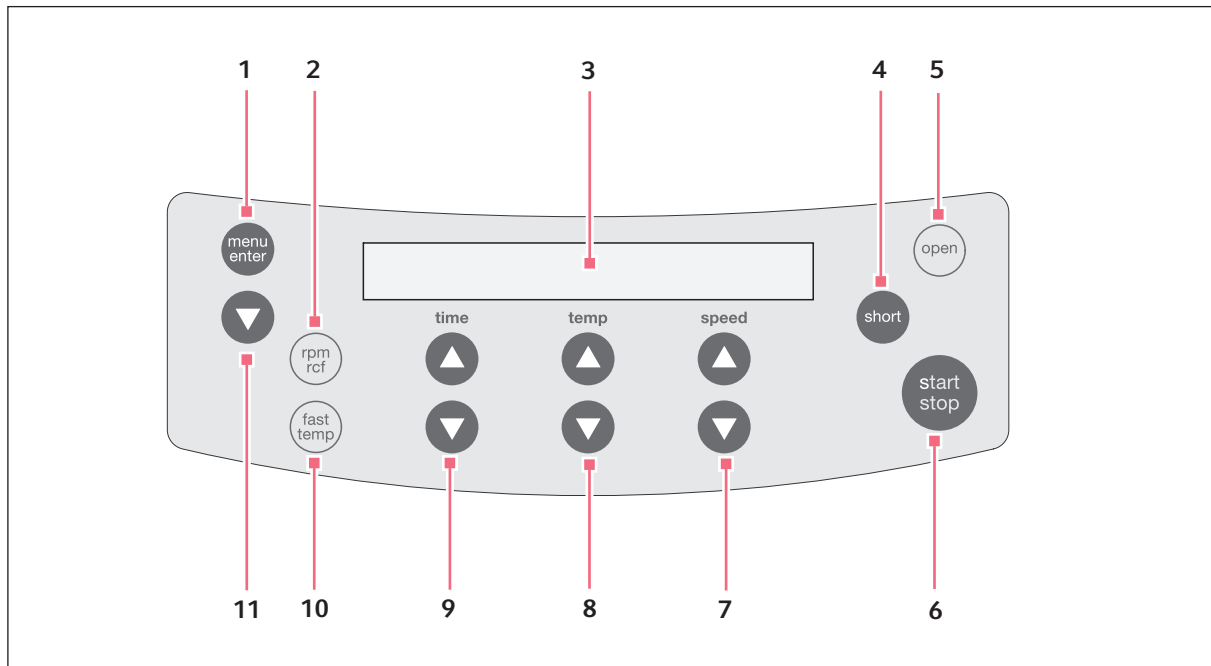

Fig. 5-1: Operating controls Centrifuge 5424 R

- |  |   |
|--|---|
| <p><b>1 menu/enter key</b><br/>Open the menu<br/>Confirm your selection</p> <p><b>2 rpm/rcf key</b><br/>Switch display of centrifugation speed (rpm or rcf)</p> <p><b>3 Display</b></p> <p><b>4 short key</b><br/>Short run centrifugation</p> <p><b>5 open key</b><br/>Release the lid</p> <p><b>6 start/stop key</b><br/>Start and stop centrifugation</p> | <p><b>7 speed arrow keys</b><br/>Set the speed of centrifugation<br/>Keep the arrow key pressed: Quick setting</p> <p><b>8 temp arrow keys</b><br/>Setting the temperature<br/>Keep the arrow key pressed: Quick setting</p> <p><b>9 time arrow keys</b><br/>Set the centrifugation time<br/>Keep the arrow key pressed: Quick setting</p> <p><b>10 fast temp key</b><br/>Start <b>fast temp</b> temperature control run</p> <p><b>11 Menu arrow key</b><br/>Navigating in the menu</p> |
|--|---|

**Operation**

Centrifuge 5424 R  
English (EN)

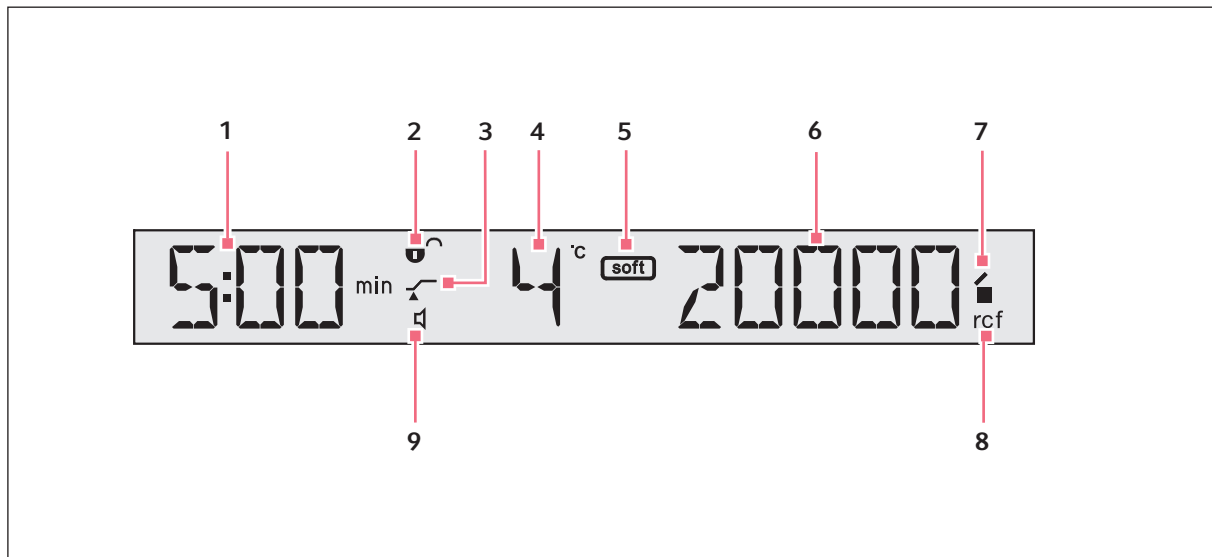

















Fig. 5-2: Display of the Centrifuge 5424 R

- |  |   |
|--|---|
| <p><b>1 Centrifugation time</b></p> <p><b>2 Status of the key lock (LOCK)</b><br/>  Centrifugation parameters cannot be accidentally changed.<br/>  No key lock.</p> <p><b>6 ATSET function</b><br/>  Start of time counting when reaching 95% of the preset <i>g</i> force (rcf) or speed (rpm)<br/>  Time counting begins immediately.</p> <p><b>4 Temperature</b></p> <p><b>5 Soft ramp</b><br/>  Rotor accelerates and brakes slowly.<br/>           No symbol: Rotor accelerates and brakes rapidly.</p> | <p><b>6 <i>g</i>-force (rcf) or speed (rpm)</b><br/>           Actual value</p> <p><b>7 Centrifuge status</b><br/>  centrifuge lid unlocked.<br/>  centrifuge lid locked.<br/>  (flashing): centrifuging in progress.</p> <p><b>8 <i>g</i>-force (rcf) or speed (rpm)</b><br/>           rcf: <i>g</i>-force (relative centrifugal acceleration).<br/>           rpm: Speed (revolutions per minute)</p> <p><b>8 Status of centrifugation speed display</b></p> <p><b>9 Speaker</b><br/>  Speaker switched on.<br/>  Speaker switched off.</p> |
|--|---|







## 5.2 Navigating in the menu



1.		To open the menu, press the <b>menu/enter</b> key.
2.		Select the menu item with the menu arrow keys.
3.		To confirm your selection, press the <b>menu/enter</b> key.
4.		Change the settings with the menu arrow key.
5.		To confirm your selection, press the <b>menu/enter</b> key.



► In order to leave a menu level, select *BACK* and confirm with the **menu/enter** key.

## 5.3 Menu structure

Menu level		Function	Symbol on the display
<i>M 1</i>	<i>M 2</i>		
<i>SOFT</i> Soft ramp Soft ramp: Reduce speed of acceleration and braking ramp. Not used for short spin centrifugation.	<i>ON</i>  <i>OFF</i>	Rotor accelerates and brakes slowly.  Rotor accelerates and brakes rapidly.	
<i>LOCK</i> Key lock Centrifugation parameters cannot be accidentally changed.	<i>ON</i>  <i>OFF</i>	<i>SAFE</i> will appear in the display when the <b>time</b> , <b>temp</b> or <b>speed</b> keys are pressed.	  
<i>ATSET</i> Setting the start for time counting	<i>ON</i>  <i>OFF</i>	Start of time counting when reaching 95% of the preset <i>g</i> force (rcf) or speed (rpm)  Time counting begins immediately.	  
<i>SHORT</i> Setting the speed of the short spin centrifugation	<i>MAX</i>  <i>SET</i>	Short run centrifugation at the maximum speed of the inserted rotor.  short spin centrifugation at the selected speed	
<i>TEMP</i> Set the time limit for continuous cooling .	<i>8 h</i>  <i>00</i>	Preset value.  Endless operation of continuous cooling. Icing possible! Note that this may reduce the service life of the compressor.	

Menu level		Function	Symbol on the display
<i>M 1</i>	<i>M 2</i>		
<i>ALARM</i>	<i>ON</i>	Switch on loudspeaker.	
	<i>OFF</i>	Switch off loudspeaker.	
<i>VOL</i>	<i>VOL1</i> ... <i>VOL5</i>	Adjust the speaker volume in 5 steps. The loudspeaker must be switched on for the adjustment to be audible.	
<i>SLEEP</i> Standby mode	<i>ON</i>	If the centrifuge has not been used for 15 min and the standby mode has been switched on, it switches to standby mode. <i>EP</i> appears in the display. To exit standby mode, press any key or close the centrifuge lid.	
	<i>OFF</i>	Standby mode deactivated.	

## 5.4 Switching on the centrifuge

- ▶ Switch the centrifuge on at the mains/power switch.
  - The parameter settings of the last run are displayed.
  - The lid opens.

## 5.5 Replacing the rotor



### **NOTICE! Material damage due to improper rotor insertion.**

The motor shaft or bearing may get damaged if the rotor falls into the motor shaft guides in an uncontrolled manner when it is inserted.

- ▶ Hold the rotor with both hands.
- ▶ Guide the rotor onto the motor shaft.

### 5.5.1 Inserting the rotor

1. Place the rotor vertically onto the motor shaft from the top.
2. Insert the supplied rotor key into the rotor nut.
3. Turn rotor key **clockwise** until the rotor nut is firmly tightened.

### 5.5.2 Removing the rotor

1. Turn the rotor nut **counterclockwise** using the supplied rotor key.
2. Lift the rotor out vertically.

## 5.6 Closing the centrifuge lid



### **WARNING! Risk of injury when opening or closing the centrifuge lid.**

There is a risk of crushing your fingers when opening or closing the centrifuge lid.

- ▶ When opening or closing the centrifuge lid, do not reach between the lid and device or into the latching mechanism of the lid.
- ▶ Always open the centrifuge lid completely to prevent it from falling.

- ▶ Check correct attachment of rotor and rotor lid.
- ▶ Push down the centrifuge lid until the lid latch engages and the lid is automatically closed.

The centrifuge will close automatically.

The **open** key lights up blue. The display shows the ■ symbol.

## 5.7 Cooling

### 5.7.1 Temperature adjustment

- ▶ Select a temperature (-10 °C to +40 °C) using the arrow keys **temp**.  
The temperature can also be changed during centrifugation.

### 5.7.2 Temperature display

If the rotor is stopped:	Set temperature
During centrifugation:	Actual temperature

### 5.7.3 Temperature monitoring

After the set temperature has been reached, the centrifuge reacts to temperature deviations during centrifugation as follows:

Deviation from the target value	Action
$\Delta T > 3^{\circ}\text{C}$	Temperature display flashes.
$\Delta T > 5^{\circ}\text{C}$	Display <i>Error 18</i> . Centrifugation is stopped automatically.

### 5.7.4 FastTemp

With this function, you can immediately start a temperature run without samples, at rotor- or temperature-specific speeds. This will quickly bring the rotor chamber, including rotor and adapter, up to the set target temperature.

Prerequisites

- The centrifuge is switched on.
- The rotor and rotor lid are attached properly.
- The centrifuge lid is closed.
- Temperature and *g*-force (rcf)/speed (rpm) for the centrifugation are set (see *Centrifugation on p. 29*).

1. Press the **fast temp** key.

The display shows *FT*, the current temperature and *g*-force (rcf)/speed (rpm).

The temperature control run automatically ends when the set temperature is reached. A periodic signal tone sounds.

2. Press the **start/stop** key to end the temperature control run early.

After the temperature control run has ended, the centrifuge maintains the rotor chamber temperature at the target temperature when the centrifuge lid is closed, if the target temperature is below the ambient temperature. However, independent of the target temperature, 4 °C must be met via this continuous cooling in order to prevent the rotor chamber from freezing.

### 5.7.5 Continuous cooling

If the rotor stops, the rotor chamber will be maintained at the target temperature if the following requirements have been met:

- The centrifuge is switched on.
- The centrifuge lid is closed.
- The set temperature is lower than the ambient temperature.

The following factors apply during the continuous cooling:

- The target temperature will be displayed.
- Independent of the target temperature, 4 °C must be achieved in order to prevent the rotor chamber or sample from freezing and to prevent increased condensation in the device.
- The temperature adjustment takes longer because the rotor is not rotating.

Open the centrifuge lid to end continuous cooling.

If the centrifuge is not used for more than 8 hours, the continuous cooling is switched off automatically. This protects against ice formation in the rotor chamber and the tubes, and against increased condensation in the device.

The device then switches to standby mode. The display shows *EP*.

You can change continuous cooling to endless operation. To do so, enable to 'oo' option in the device menu under *TEMP*. Note that this may reduce the service life of the compressor.

## 5.8 Centrifugation



### **CAUTION! Risk from incorrectly-loaded rotors and damaged/overloaded tubes!**

- ▶ Before commencing centrifugation, follow the safety instructions relating to risks from asymmetrically loaded and/or overloaded rotors and from overloaded, damaged and/or open tubes .



### **WARNING! Risk of injury from improperly attached rotors and rotor lids.**

- ▶ Only centrifuge with rotor and rotor lid firmly tightened.
  - ▶ If there are any unusual noises when the centrifuge is started up, the rotor or rotor lid may not be attached properly. Immediately press the **start/stop** key to stop centrifuging.
- 

Familiarize yourself with the operating controls and the display before using the Centrifuge 5424 R for the first time.

Each of the centrifuging variants described here must be preceded by the preparation described above .

Please also note the instructions on cooling (see p. 28).

### 5.8.1 Centrifuging with preset time

Perform the following steps in the sequence described:

1. Use **time** to set the run time.
2. Use **temp** to set the temperature.
3. Use **speed** to set the g-force (rcf) or speed (rpm).
4. Press **start/stop** to start centrifuging.

#### During centrifugation

- ■ flashes in the display while the rotor is running.
- The current temperature is displayed.
- The **fast temp, open, short** as well as the device menu are blocked during centrifugation.
- You can also terminate the centrifugation before the set run time has elapsed by pressing the **start/stop** key.

#### End of centrifugation

- The centrifuge stops automatically when the set time has elapsed. During braking the elapsed centrifugation time is displayed flashing. When the rotor stops a signal tone is heard.
  - The centrifuge lid remains closed to maintain the sample temperature. You can open it by pressing the **open** key.
5. Remove the material for centrifuging.

### 5.8.2 Centrifuging in continuous operation

Perform the following steps in the sequence described:

1. Use **time** to set the continuous run.  
The continuous run function can be set above 9:59 h or below 30 s. The timer shows **oo** to indicate continuous operation.
2. Use the **temp** arrow keys to adjust the temperature.
3. Use **speed** to set the g-force (rcf) or speed (rpm).
4. Press **start/stop** to start centrifuging.  
■ flashes in the display while the rotor is running.  
Time is counted upwards, first in second increments and then in minute increments from ten minutes.
5. Press **start/stop** to end centrifuging after the desired time period.
  - During the braking process, centrifugation time flashes in the display.
  - When the rotor stops a signal tone is heard.
  - The centrifuge lid remains closed to maintain the sample temperature. You can open it by pressing the **open** key.
6. Remove the material for centrifuging.

### 5.8.3 Short run centrifugation

You can carry out a short run with the currently set or with the maximum g-force (rcf) or speed (rpm) of the rotor used. This is set in the device menu (see *Menu structure on p. 25*) before executing the following steps in the specified sequence:

#### 5.8.3.1 Performing short spin centrifugation

1. A short run at current speed/g-force (rcf) or speed (rpm) can be set directly using the **speed** arrow keys.
2. Use the **temp** arrow keys to adjust the temperature.
3. Start short run: Hold down the **short** key.
  - ■ flashes in the display while the rotor is running.
  - The time is counted upwards in seconds.
  - During short run centrifuging all other keys are blocked.
4. End short run: Release the **short** key.
  - During the braking process, centrifugation time flashes in the display.
5. Remove the material for centrifuging.



During the braking process, you can restart the centrifugation up to two times by pressing the **short** key again.



The soft ramp does not work during short-spin centrifugation.

### 5.8.4 Removing the rotor

1. Turn the rotor nut **counterclockwise** using the supplied rotor key.
2. Lift the rotor out vertically.
3. Switch off the centrifuge after use and empty the condensation water tray (remove it from the left side of the device). Leave the centrifuge lid fully open and secure it against closing.





## 6 Maintenance

### 6.1 Service



#### WARNING! Risk of fire or electrical shock

- ▶ Have the centrifuge's electrical safety, especially the paths for the protective connections, checked every 12 months by trained and skilled personnel.

We recommend to have the centrifuge and the associated rotors checked by Technical Service during a service at least every 12 months. Please note the country-specific regulations.

### 6.2 Preparing cleaning/disinfection

- ▶ Clean all accessible surfaces of the device and the accessories at least weekly and when contaminated.
- ▶ Clean the rotor regularly. This way the rotor is protected and the durability is prolonged.
- ▶ Furthermore, observe the notes on decontamination (see *Decontamination before shipment on p. 38*) when the device is sent to the authorized Technical Service for repairs.

The procedure described in the following chapter applies to the cleaning as well as to the disinfection or decontamination. The table below describes the steps required on top of this:

Cleaning	Disinfecting/decontamination
<ol style="list-style-type: none"> <li>1. Use a mild cleaning fluid to clean the accessible surfaces of the device and the accessories.</li> <li>2. Carry out the cleaning as described in the following chapter.</li> </ol>	<ol style="list-style-type: none"> <li>1. Choose the disinfection method which corresponds to the legal regulations and guidelines in place for your range of application. For example, use alcohol (ethanol, isopropanol) or alcohol-based disinfectants.</li> <li>2. Carry out the disinfection or decontamination as described in the following chapter.</li> <li>3. Then clean the device and the accessories.</li> </ol>



If you have any further questions regarding the cleaning and disinfection or decontamination or regarding the cleaning fluid to be used, contact the Eppendorf AG Application Support. The contact details are provided on the back of this manual.

## 6.3 Cleaning/disinfection

---



### **DANGER! Electric shock due to the ingress of liquid.**

- ▶ Switch off the device and disconnect it from the mains/power line before starting cleaning or disinfection.
  - ▶ Do not allow any liquids to penetrate the inside of the housing.
  - ▶ Do not perform a spray clean/spray disinfection on the housing.
  - ▶ Only reconnect the device to the mains/power line when it is completely dry, both inside and outside.
- 



### **WARNING! Damage to health due to limited aerosol tightness in the event of incorrect use.**

Mechanical stresses and contamination by chemicals or other aggressive solvents may impair the aerosol tightness of the rotors and rotor lids. Autoclaving at excessive temperatures can lead to vessels, adapters and rotor lids becoming brittle and deformed.

- ▶ Check the integrity of the seals of the aerosol-tight rotor lids or caps before each use.
  - ▶ Only use aerosol-tight rotor lids or caps if the seals are undamaged and clean.
  - ▶ Do not exceed temperatures of 121°C or a time of more than 20 min. while autoclaving.
  - ▶ After each proper autoclaving process (121 °C, 20 min.), thinly brush the threads of the rotor lid screw with pivot grease (order no. Int. 5810 350.050, North America 022634330).
  - ▶ Replace aerosol-tight rotor lids without replaceable seals after 50 autoclaving cycles.
  - ▶ For QuickLock rotor lids, only the seal must be replaced after 50 autoclaving cycles.
  - ▶ **Never** store aerosol-tight rotors or buckets closed.
- 



### **NOTICE! Damage from the use of aggressive chemicals.**

- ▶ Do not use any aggressive chemicals on the device or its accessories, such as strong and weak bases, strong acids, acetone, formaldehyde, halogenated hydrocarbons or phenol.
- ▶ If the device has been contaminated by aggressive chemicals, clean it immediately using a mild cleaning agent.



### **NOTICE! Corrosion due to aggressive cleaning agents and disinfectants.**

- ▶ Do not use any corrosive cleaning agents, aggressive solvents or abrasive polishes.
- ▶ Do not incubate the accessories in aggressive cleaning agents or disinfectants for longer periods.



### **NOTICE! Damage from UV and other high-energy radiation.**

- ▶ Do not use UV, beta, gamma, or any other high-energy radiation for disinfection.
  - ▶ Avoid storage in areas with strong UV radiation.
-



#### **Autoclaving**

All rotors, rotor lids and adapters can be autoclaved (121 °C, 20 min).

Replace the lids on the aerosol-tight rotors after a maximum of 50 autoclaving cycles.



#### **Aerosol tightness**

Check that the seals are intact before use.

Replace the rotor lids with screw cap when the sealing rings on the lid screw and in the lid groove become worn.

Regular care of the sealing rings is necessary in order to protect the rotors.

Never store aerosol-tight rotors with the lid tightened!

To prevent damage, grease the lid thread on aerosol-tight rotors regularly using a little pivot grease (order no. int.: 5810 350.050/North America: 022634330).

### **6.3.1 Cleaning and disinfecting the device**

1. Open the lid. Switch the device off at the mains/power switch. Disconnect the mains/power plug from the voltage supply.
2. Loosen the rotor nut by turning the rotor key **counterclockwise**.
3. Remove the rotor.
4. Clean and disinfect all accessible surfaces on the device including the mains/power cord using a damp cloth and recommended cleaning agents.
5. Thoroughly clean the rubber seals of the rotor chamber with water.
6. Rub the dry rubber seals with glycerine or talcum powder to prevent them from becoming brittle. Other components of the device, such as the lid latch, motor shaft and rotor cone, must not be lubricated.
7. Clean the motor shaft with a soft, dry, lint-free cloth. Do not grease the motor shaft.
8. Check the motor shaft for damage.
9. Check the device for corrosion and damage.
10. Leave the centrifuge lid open when the device is not being used.
11. Only connect the device to the power supply if it is fully dry inside and out.

### 6.3.2 Disinfecting and cleaning the rotor

1. Inspect the rotor and accessories for damage and corrosion. Do not use any damaged rotors or accessories.
2. Clean and disinfect the rotors and accessories using the recommended cleaning agents.
3. Clean and disinfect the rotor bores using a bottle brush.
4. Rinse the rotors and accessories thoroughly with distilled water. Rinse the rotor bores of fixed-angle rotors particularly thoroughly.



Do not immerse the rotor in liquid as liquid can enter through the openings when doing so.

5. Place the rotors and accessories on a towel to dry. Place fixed-angle rotors with the rotor bores facing downwards to allow the bores to also dry.
6. Clean the rotor cone with a soft, dry, lint-free cloth. Do not lubricate the rotor cone.
7. Inspect the rotor cone for damage.
8. Place the dry rotor onto the motor shaft.
9. Tighten the rotor nut firmly by turning it **clockwise** with the rotor key.
10. Leave the rotor lid open when the rotor is not being used.

### 6.4 Additional care instructions for refrigerated centrifuges

- ▶ Empty and clean the condensation water tray regularly and especially after liquid spillage in the rotor chamber. Pull out the condensation water tray at the front right under the device.
- ▶ Regularly free the rotor chamber from ice formations by thawing, by either leaving the centrifuge lid open or by performing a short temperature control run at approx. 30 °C.
- ▶ Wipe up the condensation water in the rotor chamber. Use a soft, absorbent cloth for this.
- ▶ No later than every 6 months, remove any dust deposits from the ventilation slits of the centrifuge using a brush or swab. First switch off the device and remove the power plug.

## 6.5 Cleaning glass breakage

When using glass tubes there is a risk of glass breakage in the rotor chamber. The resulting glass splinters are swirled around in the rotor chamber during centrifugation and have a sandblasting effect on the rotor and accessories. Smallest glass particles become lodged in the rubber parts (e.g., the motor sleeve, the rotor chamber seal, and the rubber mats of adapters).



### **NOTICE! Glass breakage in the rotor chamber**

Glass tubes in the rotor chamber may break if the  $g$ -force is too high. Broken glass can damage the rotor, accessories and samples.

- ▶ Please note the manufacturer's information on the recommended centrifugation parameters (load and speed).

### **Effects of glass breakage in the rotor chamber:**

- Fine black metal abrasion dust in the rotor chamber (in metal rotor bowls).
- The surfaces of the rotor chamber and accessories are scratched.
- The chemical resistance of the rotor chamber is reduced.
- Contamination of samples.
- Wear on rubber parts.

### **How to proceed in case of glass breakage**

1. Remove all splinters and glass powder from the rotor chamber and accessories.
2. Thoroughly clean the rotor and rotor chamber. Thoroughly clean the bores of the fixed-angle rotors, in particular.
3. If required, replace the adapters to prevent any further damage.
4. Regularly check the rotor bores for deposits and damage.

## 6.6 Fuses

The fuse holder is located to the right of the mains switch.

1. Disconnect the mains/power plug.
2. Remove the fuse holder.

Both fuses are now accessible and can be replaced.

## 6.7 Decontamination before shipment

If you are shipping the device to the authorized Technical Service for repairs or to your authorized dealer for disposal please note the following:



**WARNING! Risk to health from contaminated device.**

1. Observe the information in the decontamination certificate. It is available as a PDF document on our webpage ([www.eppendorf.com/decontamination](http://www.eppendorf.com/decontamination)).
  2. Decontaminate all the parts you are going to dispatch.
  3. Include the fully completed decontamination certificate in the shipment.
-

## 7 Troubleshooting

If you cannot remedy an error with the recommended measures, please contact your local Eppendorf partner. The contact addresses can be found on the Internet at [www.eppendorf.com](http://www.eppendorf.com).

### 7.1 General errors

Problem	Cause	Solution
No display.	No mains/power connection.	▶ Check the mains/power connection.
	Mains/power outage.	▶ Check the fuse of the centrifuge. ▶ Check the mains/power fuse of the lab.
The centrifuge lid cannot be opened.	Rotor is still running.	▶ Wait for the rotor to stop.
	Mains/power outage.	1. Check the fuse of the centrifuge. 2. Check the mains/power fuse of the lab. 3. Activate the emergency lid release.
The centrifuge cannot be started.	Centrifuge lid is not closed.	▶ Close the centrifuge lid.
Centrifuge shakes when it starts up.	Rotor loaded asymmetrically.	1. Stop the centrifuge and load symmetrically. 2. Re-start the centrifuge.
Centrifuge brakes during a short run centrifugation, although the <b>short</b> key is pressed.	The <b>short</b> key was released briefly more than twice (protective function for the drive).	▶ Press the <b>short</b> key continuously during a short run centrifugation.
Temperature display flashes.	Temperature deviation from set value: $\pm 3$ °C.	▶ Check the settings. ▶ Check unhindered air circulation through the air slots. ▶ Thaw ice or switch off the centrifuge and allow it to cool down.

## 7.2 Error messages

If one of the following error messages appears, proceed as follows:

1. Remove fault (see Remedies).
2. If necessary, repeat centrifugation.

Problem	Cause	Solution
<b>LID ERROR</b>	Centrifuge lid cannot be locked.	▶ Try again to close centrifuge lid.
<b>LID ERROR</b>	Centrifuge lid cannot be released.	1. Switch the centrifuge off and back on.  If the error occurs again: 1. Switch off the centrifuge. 2. Activate the emergency lid release .
<b>LID ERROR</b>	Centrifuge lid must not be released during a run.	▶ Wait for the rotor to stop.
<b>LID LIFT</b>	Centrifuge lid has not been opened wide enough.	▶ Open the centrifuge lid wider by hand.
<b>INT</b>	Mains/power failure during a run.	▶ Check the mains/power connection.
<b>NO RPM</b>	Error in the speed measuring system or drive overheated.	▶ Leave the device switched on until the error message disappears (10 s or 6 min).
<b>Err 6</b>	Drive fault.	▶ Repeat the run. ▶ If this error message appears again, switch centrifuge off and back on again after >20 s.
<b>Err 6</b>	Drive overheated.	▶ Allow the drive to cool down for at least 15 min.
<b>Err 7</b>	Major deviation in the speed check.	1. Wait for the rotor to stop. 2. Tighten the rotor.
<b>Err 8</b>	Drive fault.	1. Wait for the rotor to stop. 2. Repeat the run.
<b>Err 9 to 17</b>	Electronics error.	▶ Switch centrifuge off and back on again after >20 s.
<b>Err 18</b>	Too high temperature deviation from set value in the rotor chamber.	▶ Check the settings. ▶ Check unhindered air circulation through the air slots. ▶ Thaw ice or switch off the centrifuge and allow it to cool down.
<b>Err 19</b>	Cooling circuit is overheated.	▶ Check unhindered air circulation through the air slots and allow the centrifuge to cool down.



Problem	Cause	Solution
Err 20	Temperature sensor in rotor chamber is faulty.	▶ Switch centrifuge off and back on again after >20 s.
Err 21	The temperature sensor on the condenser is faulty.	▶ Switch centrifuge off and back on again after >20 s.
Err 24	Cooling unit fault, e.g. overheated.	▶ Allow the centrifuge to cool down and repeat the run.

### 7.3 Emergency release

If the centrifuge lid cannot be opened, you can activate the emergency release manually.



**WARNING! Risk of injury from rotating rotor.**

If the emergency release of the lid is operated, the rotor may continue to rotate for several minutes.

- ▶ Wait for the rotor to stop before activating the emergency release.
- ▶ To check, look through the monitoring glass in the centrifuge lid.



Use the rotor key delivered with the Centrifuge 5424 R for the emergency release.

1. Disconnect the mains/power plug.
2. Remove the plastic cover for the emergency release on the right side of the device. Turn the plastic cover 90° **counterclockwise** using an appropriate tool (e.g., screwdriver) and remove it.
3. Insert the centrifuge rotor key in the rear hexagonal opening until a noticeable resistance is felt.
4. **Slightly press** and turn the rotor key counterclockwise.  
This will release the centrifuge lid.
5. Open the centrifuge lid.
6. Remove the rotor key or turn the plastic covers back on.  
Turn the plastic cover using an appropriate tool (e.g., screwdriver) by 90° in a **clockwise** direction.



## 8 Transport, storage and disposal

### 8.1 Transport



**CAUTION! Risk of injury due to lifting and carrying of heavy loads**

The device is heavy. Lifting and carrying the device can lead to back injuries.

- ▶ Transport and lift the device with an adequate number of helpers only.
- ▶ Use a transport aid for transporting the device.

- ▶ Remove the rotor from the centrifuge before transport.
- ▶ Use the original packing for transport.

	Air temperature	Relative humidity	Atmospheric pressure
General transport	-25 °C – 60 °C	10 % – 75 %	30 kPa – 106 kPa
Air freight	-20 °C – 55 °C	10 % – 75 %	30 kPa – 106 kPa

### 8.2 Storage

	Air temperature	Relative humidity	Atmospheric pressure
In transport packing	-25 °C – 55 °C	10 % – 75 %	70 kPa – 106 kPa
Without transport packing	-5 °C – 45 °C	10 % – 75 %	70 kPa – 106 kPa

### 8.3 Disposal

If the product needs to be disposed of, the relevant legal regulations must be observed.

#### **Information on the disposal of electrical and electronic devices in the European Community:**

Within the European Community, the disposal of electrical devices is regulated by national regulations based on EU Directive 2012/19/EU pertaining to waste electrical and electronic equipment (WEEE).

According to these regulations, any devices supplied after August 13, 2005, in the business-to-business sphere, to which this product is assigned, may no longer be disposed of in municipal or domestic waste. To document this, they have been marked with the following marking:



Because disposal regulations may differ from one country to another within the EU, please contact your supplier if necessary.

## 9 Technical data

### 9.1 Power supply

#### Centrifuge 5424 R

Mains/power connection	230 V, 50 to 60 Hz 120 V, 50 to 60 Hz 100 V, 50 to 60 Hz
Current consumption	1.6 A (230 V) 3.2 A (120 V) 3.4 A (100 V)
Power consumption	max. 350 W
EMC: Interference emitted (radio interference)	230 V: EN 61326-1/EN 55011 – Class A 120 V: CFR 47 FCC Part 15 – Class B 100 V: EN 61326-1/EN 55011 – Class B
EMC: Interference resistance	EN 61326-1
Overvoltage category	II
Fuses – 230 V	3.15 AT HBC 250 V
Fuses – 120 V	6.3 AT 250 V
Fuses – 100 V	6.3 AT 250 V

### 9.2 Ambient conditions

Environment:	For indoor use only.
Ambient temperature:	10 to 40 °C
Max. relative humidity:	10 75 %, no condensing humidity
Atmospheric pressure:	79.5 kPa – 106 kPa
Degree of pollution:	2

### 9.3 Weight/dimensions

#### Centrifuge 5424 R

Dimensions:	Width: 290 mm (11.42 in.) Depth: 480 mm (18.90 in.) Height: 260 mm (10.24 in.)
Weight without rotor:	21.0 kg (46.3 lb)
Rotor weights:	
FA-45-24-11	800 g
FA-45-24-11-Special	1 600 g
FA-45-18-11-Kit	650 g
F-45-32-5-PCR	460 g

## 9.4 Noise level

The noise level was measured according to DIN EN ISO 3745 frontally in a sound measuring room with accuracy class 1 at a distance of 1 m from the device and at lab bench height.

Noise level	< 54 dB(A)
-------------	------------

## 9.5 Application parameters

### 9.5.1 Centrifuge 5424 R

Tab. 9-1: Acceleration time and braking time according to DIN 58 970

Rotor	Without soft ramp		With soft ramp <i>SOFT</i>	
	Acceleration time	Deceleration time	Acceleration time	Deceleration time
FA-45-24-11	15 s	16 s	26 s	28 s

These values were calculated for 230 V at 23°C.

Cycle time	30 s - 9:59 h, as well as infinity ( <b>∞</b> ), up to 10 min cycle time adjustable in 0.5 min increments, then in 1 min increments
Temperature	-10°C - 40°C
Relative centrifugal force (RCF)	$1 \times g - 21\,130 \times g$ , adjustable in $50 \times g$ increments.
Rotational speed:	100 rpm – 15000 rpm, adjustable in 50 rpm increments.
Maximum load	24 micro test tubes of 2.0 mL each
Maximum kinetic energy	4070 J
Compulsory test log book	No
Allowable density of the material for centrifuging (at maximum <i>g</i> -force/speed and maximum load)	1.2 g/mL

## 9.6 Service life for accessories



**CAUTION! Danger due to material fatigue.**

When the service life is exceeded, it cannot be guaranteed that the material of the rotors and the accessories will withstand the stresses during centrifugation.

- ▶ Do not use any accessories which have exceeded their maximum service life.

Eppendorf states the maximum service life of the rotors and accessories both in years and in the maximum number of cycles. The decisive factor for the service life is which case occurs first, usually this is the number of years in operation.

Each centrifugation run in which the rotor is accelerated and braked is counted as a cycle, independent of the speed and the duration of the centrifugation run.

All other rotors and rotor lids can be used during the entire service life of the centrifuge if the following conditions are met:

- Proper use
- Recommended maintenance
- Undamaged condition

Accessories	Maximum service life after initial setup	
Rotor lid of polycarbonate (PC), polypropylene (PP) or polyetherimide (PEI)	–	3 years
Aerosol-tight rotor lid, without replaceable seals	50 autoclaving cycles	–
QuickLock rotor lid		3 years
Seals in the QuickLock rotor lid	50 autoclaving cycles	–
Adapters	–	1 year

The date of manufacture is stamped on the rotors and buckets in the format 03/15 or 03/2015 (= March 2015). On the inside of the plastic-rotor lids and aerosol-tight caps, the date of manufacture is stamped in the form of a clock ⌚.

**Measures to ensure aerosol tightness:**

- ▶ Replace the seal of QuickLock rotor lids after 50 autoclaving cycles.
- ▶ Exchange aerosol-tight rotor lid without replaceable seals after 50 autoclaving cycles.

## 9.7 Rotors



Eppendorf centrifuges may only be operated with rotors that are intended for use with the corresponding centrifuge.

- ▶ Only use rotors that are intended for use with the corresponding centrifuge.

Please note the manufacturer's information on the centrifugation resistance of the sample tubes used (maximum *g*-force).

For ordering information, refer to the English and German version of the operating manual.

	Max. capacity	Max. g-force (rcf) or speed (rpm) without adapter	Notes
		Max. load per rotor bore <sup>(1)</sup>	
<b>Rotor FA-45-24-11</b>	24 micro test tubes of 1.5/2.0 ml each or spin columns. With adapters: <ul style="list-style-type: none"> <li>• 0.2 mL PCR tubes</li> <li>• 0.4 ml/0.5 ml micro test tubes</li> <li>• 0.6 mL Microtainers</li> </ul>	21.130 x g/ 15.000 rpm	<ul style="list-style-type: none"> <li>• Aerosol-tight<sup>(2)</sup> rotor lid (aluminum).</li> <li>• Spin columns available, better with rotor FA-45-18-11-kit.</li> </ul>
		3.75 g	
<b>Rotor FA-45-24-11-Special</b>	24 micro test tubes of 1.5/2.0 ml each or spin columns. With adapters: <ul style="list-style-type: none"> <li>• 0.2 mL PCR tubes</li> <li>• 0.4 ml/0.5 ml micro test tubes</li> <li>• 0.6 mL Microtainers</li> </ul>	21.130 x g/ 15.000 rpm	<ul style="list-style-type: none"> <li>• Aerosol-tight<sup>(2)</sup> rotor lid (aluminum).</li> <li>• PTFE-coated (particularly resistant to chemicals), marked: <i>coated</i>.</li> <li>• Spin columns available, better with rotor FA-45-18-11-kit.</li> </ul>
		3.75 g	
<b>Rotor F-45-18-11-Kit</b>	18 spin columns or 1.5/2.0 ml tubes. With adapters: <ul style="list-style-type: none"> <li>• 0.2 mL PCR tubes</li> <li>• 0.4 ml/0.5 ml micro test tubes</li> <li>• 0.6 mL Microtainers</li> </ul>	18.111 x g/ 15.000 rpm	<ul style="list-style-type: none"> <li>• Uniquely high edge, for all commercial spin columns. Also observe the note on centrifugation with open tube lids (see <i>Extreme strain on the centrifugation tubes on p. 11</i>).</li> </ul>
		3.75 g	
<b>Rotor F-45-32-5-PCR</b>	Four PCR strips (5/8) or 32 0.2 ml PCR vials.	18.615 x g/ 15.000 rpm	
		3.5 g	

(1) Maximum load per rotor bore for adapter + tube + contents.

(2) Aerosol tightness tested and certified by the Centre of Emergency Preparedness and Response, Health Protection Agency, Porton Down (UK) (see certificates at the end of this operating manual).



For the rotors and rotor lids labeled *coated*, color fluctuations may occur as a result of the production process. These fluctuations have no effect on service life or resistance to chemicals.

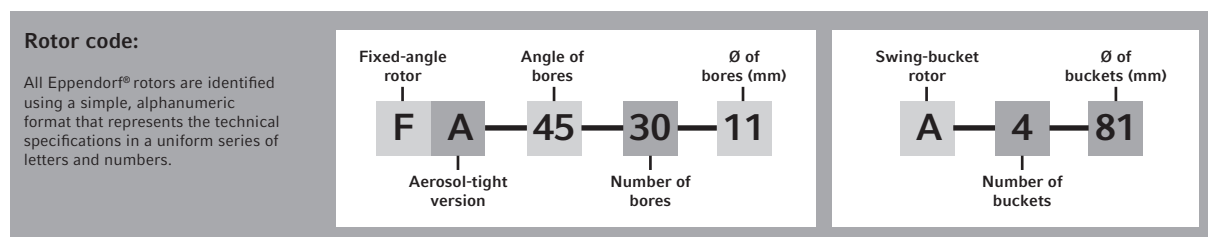

### 9.7.1 rcf display and calculation



Use the **rpm/rcf** key to switch the display of centrifugation speed between **g-force** (rcf) and **speed** (rpm). Ensure that the g-force displayed during switching is standardized to suit the rotor in question without an adapter. When adapters are used, the following maximum g-forces (rcf) can be achieved at maximum speed:

Rotor	Adapter	Max. centrifugation radius $r_{\max}$ [cm]	Max. g-force (rcf)
FA-45-24-11, FA-45-24-11-Special	Without adapter	8.4	21.130
	0.2 mL	6.3	15.848
	0.4 mL	8.4	21.130
	0.5 mL	7.3	18.363
	0.6 mL	8.4	21.130
F-45-18-11-Kit	Without adapter	7.2	18.111
	0.2 mL	5.1	12.829
	0.4 mL	7.2	18.111
	0.5 mL	6.1	15.345
	0.6 mL	7.2	18.111
FA-45-32-5-PCR	Without adapter	7.4	18.615

To determine the g-force (rcf) for a special adapter, you can perform a calculation according to DIN 58 970 with the following formula:

$$\text{rcf} = 1.118 \cdot 10^{-5} \cdot n^2 \cdot r_{\max}$$

n: Revolutions per minute (rpm)

$r_{\max}$ : Max. centrifugation radius in cm

**Example:**

In Rotor FA-45-24-11, the 0.5 ml adapter has a maximum radius of 7.3 cm. At 7,000 rpm, a maximum g-force of 4,000 x g is achieved.



## 10 Ordering information

### 10.1 Accessories

#### 10.1.1 Rotors and rotor lids

Order no. (International)	Description
5424 702.007	<b>Rotor FA-45-24-11</b> aerosol-tight, aluminum, 45° angle, 24 places, max. tube diameter 11 mm, incl. rotor lid (aluminum)
5424 703.003	<b>Replacement lid for rotor FA-45-24-11</b> aerosol-tight, aluminum
5424 700.004	<b>Rotor FA-45-24-11-Special</b> aerosol-tight, aluminum, PTFE-coated, 45° angle, 24 places, max. tube diameter 11 mm, incl. rotor lid (aluminum)
5424 701.000	<b>Replacement lid for rotor FA-45-24-11-Special</b> aerosol-tight, aluminum, PTFE-coated
5424 706.002	<b>Rotor F-45-18-11-Kit</b> aluminum, 45° angle, 18 places, max. tube diameter 11 mm, incl. rotor lid (polypropylene)
5424 707.009	<b>Spare lid for rotor F-45-18-11-Kit</b> Polypropylene
5424 704.000	<b>Rotor F-45-32-5-PCR</b> incl. rotor lid (aluminum)
5424 708.005	<b>Spare lid for rotor F-45-32-5-PCR</b> aluminum

\*) Aerosol impermeability tested and certified by the Centre of Emergency Preparedness and Response, Health Protection Agency, Porton Down (UK).

#### 10.1.2 Adapter

Order no. (International)	Description
5425 715.005 5425 717.008 5425 716.001	<b>Adapter</b> used in FA-45-24-11, FA-45-24-11-Special and F-45-18-11-Kit for 1 PCR tube (0.2 mL, max. Ø 6 mm), set of 6 for 1 micro test tube (0.4 mL, max. Ø 6 mm), set of 6 for 1 sample tube (0.5 mL, max. Ø 6 mm) or 1 Microtainer (0.6 mL, max. Ø 8 mm), set of 6

**Ordering information**Centrifuge 5424 R  
English (EN)**10.1.3 Other accessories**

<b>Order no. (International)</b>	<b>Description</b>
5416 301.001	<b>Rotor key</b> Standard
5404 850.085	<b>Tray for condensation water</b>

**10.2 Fuses**

<b>Order no. (International)</b>	<b>Description</b>
5424 852.122	<b>Fuse</b> 3,15 A T (230 V), set of 2
5424 852.130	6,3 A T (120 V/100 V), set of 2

# Declaration of Conformity

The product named below fulfills the requirements of directives and standards listed. In the case of unauthorized modifications to the product or an unintended use this declaration becomes invalid. This declaration of conformity is issued under the sole responsibility of the manufacturer.

**Product name:**

Centrifuge 5424 R  
including components

**Product type:**

Centrifuge

**Relevant directives / standards:**

- 98/79/EC: EN ISO 14971, EN 61010-2-101, EN 61326-2-6, EN 62366  
EN ISO 18113-1, EN ISO 18113-3, EN ISO 15223-1
- 2014/35/EU: EN 61010-1, EN 61010-2-020, IEC 61010-1, IEC 61010-2-020  
UL 61010-1, CAN/CSA C22.2 No. 61010-1
- 2014/30/EU: EN 61326-1, EN 55011  
CFR 47 FCC part 15
- 2014/68/EU: EN 378-1, EN 378-2
- 2011/65/EU: EN 50581

Hamburg, January 31<sup>st</sup>, 2018



Dr. Wilhelm Plüster  
Management Board



Dr. Sven Bülow  
Head of Business Unit  
Centrifugation

Your local distributor: [www.eppendorf.com/contact](http://www.eppendorf.com/contact)  
Eppendorf AG · Barkhausenweg 1 · 22339 Hamburg · Germany  
[eppendorf@eppendorf.com](mailto:eppendorf@eppendorf.com)

Eppendorf® and the Eppendorf Brand Design are registered trademarks of Eppendorf AG, Germany. All rights reserved, incl. graphics and pictures. Copyright ©2017 by Eppendorf AG.

[www.eppendorf.com](http://www.eppendorf.com)

ISO  
9001  
Certified

ISO  
13485  
Certified

ISO  
14001  
Certified



# CERTIFICATE OF COMPLIANCE

**Certificate Number** 20160919-E215059  
**Report Reference** E215059-A1-UL  
**Issue Date** 2016-SEPTEMBER-19

**Issued to:** EPPENDORF A G  
BARKHAUSENWEG 1  
22339 HAMBURG GERMANY

**This is to certify that  
representative samples of**

LABORATORY-USE ELECTRICAL EQUIPMENT  
Centrifuge, 5404 (5424R)

Have been investigated by UL in accordance with the  
Standard(s) indicated on this Certificate.

**Standard(s) for Safety:**

UL 61010-1 and CAN/CSA C22.2 NO. 61010-1 - Safety  
Requirements For Electrical Equipment For Measurement,  
Control, And Laboratory Use — Part 1: General  
Requirements

**Additional Information:**

See the UL Online Certifications Directory at  
[www.ul.com/database](http://www.ul.com/database) for additional information

Only those products bearing the UL Certification Mark should be considered as being covered by UL's  
Certification and Follow-Up Service.

Look for the UL Certification Mark on the product.



Bruce Mahrenholz, Director North American Certification Program

UL LLC

Any information and documentation involving UL Mark services are provided on behalf of UL LLC (UL) or any authorized licensee of UL. For questions, please  
contact a local UL Customer Service Representative at <http://ul.com/about/locations/>









## Certificate of Containment Testing

Containment Testing of Rotor FA 45-24-11  
(5424 700.101-00, 50 x autoclaved at 121°C  
for 20 minutes) in Eppendorf Centrifuge  
5424 / 5424R

Report No. 73-08 A

**Report prepared for:** Eppendorf AG, Hamburg, Germany  
**Issue Date:** 10<sup>th</sup> March 2008 (amended 24<sup>th</sup> Sept 2009)

### Test Summary

Rotor FA 45-24-11 (5424 700.101-00, 50 x autoclaved at 121°C for 20 minutes) was containment tested in the Eppendorf 5424 / 5424R centrifuge, using Annex AA of IEC 1010-2-20. The rotor was shown to contain a spill within the rotor.

**Report Written By**

*Anna May*  
-----

**Report Authorised By**

*[Signature]*  
-----





## Certificate of Containment Testing

Rotor FA 45-24-11-Special  
(5424 700.101-00) in Eppendorf centrifuge  
5424 / 5424R

Report No. 959-05 B

**Report prepared for:** Eppendorf AG, Hamburg, Germany  
**Issue Date:** 29<sup>th</sup> June 2005 (amended 24<sup>th</sup> Sept 2009)

### Test Summary

The FA 45-24-11-Special rotor (5424 700.101-00) was containment tested in the Eppendorf centrifuge 5424 / 5424R, using Annex AA of IEC 1010-2-20. The rotor was shown to contain a large spill within the rotor.

**Report Checked By**

*Anna May*  
-----

**Report Written and Authorised By**

*[Signature]*  
-----





# Evaluate Your Manual

Give us your feedback.  
[www.eppendorf.com/manualfeedback](http://www.eppendorf.com/manualfeedback)



**Eppendorf AG**  
Barkhausenweg 1  
22339 Hamburg  
Germany

**Your local distributor: [www.eppendorf.com/contact](http://www.eppendorf.com/contact)  
[eppendorf@eppendorf.com](mailto:eppendorf@eppendorf.com) · [www.eppendorf.com](http://www.eppendorf.com)**