

Register your instrument!
www.eppendorf.com/myeppendorf



Centrifuge 5420

Operating Manual

Copyright ©2021 Eppendorf SE, Germany. All rights reserved, including graphics and images. No part of this publication may be reproduced without the prior permission of the copyright owner.

Microtainer® is a registered trademark of Becton Dickinson, USA.

Eppendorf® and the Eppendorf Brand Design are registered trademarks of Eppendorf SE, Germany.

Eppendorf VisioNize® is a registered trademark of Eppendorf SE, Germany.

Registered trademarks and protected trademarks are not marked in all cases with ® or ™ in this manual.

Table of contents

1	Operating instructions	7
1.1	Using this manual	7
1.2	Danger symbols and danger levels	7
1.2.1	Danger symbols	7
1.2.2	Danger levels	7
1.3	Symbols used	7
1.4	Abbreviations used	8
2	Safety	9
2.1	Intended use	9
2.2	User profile	9
2.3	Application limits	9
2.4	Warnings for intended use	10
2.4.1	Personal injury or damage to device	10
2.4.2	Incorrect handling of the centrifuge	12
2.4.3	Incorrect handling of the rotors	12
2.4.4	Extreme strain on the centrifugation tubes	13
2.5	Safety instructions on the device and accessories	14
2.6	Obligation to report accidental damage or damage to the device	14
2.6.1	Manufacturer Eppendorf SE	14
2.6.2	Local Eppendorf distributor	14
3	Product description	15
3.1	Product overview	15
3.2	Delivery package	16
3.3	Features	16
3.4	Name plate	17
4	Installation	19
4.1	Selecting the location	19
4.2	Preparing installation	20
4.3	Installing the instrument	21
5	Operation	23
5.1	Operating controls	23
5.2	Menu	25
5.2.1	Navigating the menu	25
5.2.2	Menu structure	25
5.3	Switching on the centrifuge	26
5.4	Replacing the rotor	27
5.4.1	Inserting the rotor	27
5.4.2	Removing the rotor	27
5.5	Closing the centrifuge lid	27
5.6	Preparing for centrifugation	27
5.6.1	Loading the rotor	27
5.6.2	Closing the rotor lid	28
5.6.3	Closing the rotor lid (aerosol-tight centrifugation)	28

Table of contentsCentrifuge 5420
English (EN)

5.7	Centrifugation	29
5.7.1	Centrifuging with preset time	29
5.7.2	End of centrifugation	30
5.7.3	Centrifuging in continuous operation	30
5.7.4	Short run centrifugation	31
5.7.5	Setting the acceleration ramp and braking ramp	31
5.7.6	Setting the start for time counting (ATSET)	31
5.7.7	Setting the start of the centrifugation run (TIMER)	32
5.7.8	Setting alarms	32
5.8	Aerosol-tight centrifugation	33
5.9	Switching off the centrifuge	33
6	Programs	35
6.1	Creating a new program	35
6.1.1	Saving a program	35
6.1.2	Adding write protection to a program	35
6.2	Loading a saved program	36
6.2.1	Loading program prog 1 to prog 3	36
6.3	Overwriting programs	36
6.3.1	Removing the write protection of programs	36
6.3.2	Editing programs	36
7	Device settings	37
7.1	Setting alarms	37
7.1.1	Activating the alarm	37
7.1.2	Deactivating the alarm	37
7.2	Sleep mode	37
7.2.1	Activating the sleep mode	37
7.2.2	Deactivating the sleep mode	38
7.3	Automatic lid opening	38
7.3.1	Activating automatic lid opening	38
7.3.2	Deactivating automatic lid opening	38
8	Maintenance	39
8.1	Service options	39
8.2	Service	39
8.3	Prepare cleaning/disinfection	39
8.4	Performing cleaning/disinfection	40
8.4.1	Cleaning and disinfecting the device	41
8.4.2	Cleaning and disinfecting the rotor	41
8.4.3	Cleaning the rotor lid and replacing the seal	42
8.5	Cleaning glass breakage	43
8.6	Replacing fuses	43
8.7	Decontamination before shipment	44
9	Troubleshooting	45
9.1	General errors	45
9.2	Error messages	45
9.3	Emergency release	47

10	Transport, storage and disposal	49
10.1	Transport	49
10.2	Storage	49
10.3	Disposal	49
11	Technical data	51
11.1	Power supply	51
11.2	Ambient conditions	51
11.3	Weight/dimensions	52
11.4	Noise level	52
11.5	Application parameters	52
11.6	Service life of accessories	53
12	Rotors for the Centrifuge 5420	55
12.1	Rotor FA-24x2	55
12.2	Rotor F-32x0.2-PCR	56
13	Ordering Information	57
	Certificates	59

Table of contents

Centrifuge 5420
English (EN)

1 Operating instructions







1.1 Using this manual

- ▶ Read this operating manual completely before using the device for the first time. Observe the instructions for use of the accessories where applicable.
- ▶ This operating manual is part of the product. Please keep it in a place that is easily accessible.
- ▶ Enclose this operating manual when transferring the device to third parties.
- ▶ The current version of the operating manual for all available languages can be found on our webpage www.eppendorf.com/manuals.

1.2 Danger symbols and danger levels

1.2.1 Danger symbols

The safety instructions in this manual have the following danger symbols and danger levels:

	Biohazard		Explosive substances
	Electric shock		Risk of crushing
	Hazard point		Material damage

1.2.2 Danger levels

DANGER	Will lead to severe injuries or death.
WARNING	May lead to severe injuries or death.
CAUTION	May lead to light to moderate injuries.
NOTICE	May lead to material damage.

1.3 Symbols used

Depiction	Meaning
1. 2.	Actions in the specified order
▶	Actions without a specified order
•	List
<i>Text</i>	Display or software texts
	Additional information

1.4 Abbreviations used

CE

European Community – A CE indicates that a product has been tested before being placed on the market and complies with the safety, health and/or environmental protection requirements of the European Union.

PCR

Polymerase Chain Reaction

PTFE

Polytetrafluorethylene

rcf

Relative centrifugal force : g -force in m/s^2

rpm

Revolutions per minute

UV

Ultraviolet radiation

2 Safety

2.1 Intended use

The Centrifuge 5420 is a non-automatic centrifuge for separating liquid substance mixtures from the human body and is specifically intended for use as an accessory with an in-vitro diagnostic device in order to facilitate the in-vitro diagnostic device to be used in accordance with its intended use.

Eppendorf centrifuges are only intended for indoor use and for operation by trained and skilled personnel.

2.2 User profile

The device and accessories may only be operated by trained and skilled personnel.

Before using the device, read the operating manual and the instructions for use of the accessories carefully and familiarize yourself with the device's mode of operation.

2.3 Application limits



DANGER! Risk of explosion.

- ▶ Do not use the device in an explosive atmosphere.
 - ▶ Do not operate the device in areas where work with explosive substances is carried out.
 - ▶ Do not use this device to process any explosive or highly reactive substances.
 - ▶ Do not use this device to process any substances which could create an explosive atmosphere.
-

Due to its design and the environmental conditions inside the device, the Centrifuge 5420 is not suitable for use in a potentially explosive atmosphere.

The device must be used only in a safe environment, such as in the open environment of a ventilated laboratory or a fume hood. The use of substances which could create a potentially explosive atmosphere is not permitted. It is the user's responsibility to make the final decision on the risks associated with the use of such substances.

2.4 Warnings for intended use

2.4.1 Personal injury or damage to device



WARNING! Electric shock due to damage to the device or mains/power cord.

- ▶ Only switch on the device if the device and the mains/power cord are undamaged.
- ▶ Only operate devices which have been installed or repaired properly.
- ▶ In case of danger, disconnect the device from the mains/power supply voltage. Disconnect the mains/power plug from the device or the earth/grounded socket. Use the disconnecting device intended for this purpose (e.g., the emergency switch in the laboratory).



WARNING! Lethal voltages inside the device.

Touching parts under high voltage can cause an electric shock. Electric shocks cause injuries to the heart and respiratory paralysis.

- ▶ Ensure that the housing is closed and undamaged.
 - ▶ Do not remove the housing.
 - ▶ Make sure that no liquids can enter the device.
- Only authorized service staff may open the device.



WARNING! Danger due to incorrect voltage supply.

- ▶ Only connect the device to voltage sources which correspond with the electrical requirements on the name plate.
- ▶ Only use earth/grounded sockets with a protective earth (PE) conductor.
- ▶ Only use mains/power cords that are approved for the technical data specified on the name plate and taking into account national laws and regulations. This also includes testing labels if required by law.



WARNING! Damage to health due to infectious liquids and pathogenic germs.

- ▶ When handling infectious liquids and pathogenic germs, observe the national regulations, the biosafety level of your laboratory, and the manufacturers' Safety Data Sheets and application notes.
- ▶ Wear your personal protective equipment.
- ▶ Consult the "Laboratory Biosafety Manual" (source: World Health Organization, Laboratory Biosafety Manual, as amended) for comprehensive regulations on the handling of germs or biological material of risk group II or higher.



WARNING! Risk of injury when opening or closing the centrifuge lid.

There is a risk of crushing your fingers when opening or closing the centrifuge lid.

- ▶ Do not reach between the device and centrifuge lid when opening or closing the centrifuge lid.
- ▶ Do not reach into the locking mechanism of the centrifuge lid.
- ▶ Open the centrifuge lid fully to ensure that the centrifuge lid cannot slam shut.



WARNING! Risk of injury from rotating rotor.

If the emergency release of the lid is operated, the rotor may continue to rotate for several minutes.

- ▶ Wait for the rotor to stop before activating the emergency release.
- ▶ To check, look through the monitoring glass in the centrifuge lid.



WARNING! Risk of injury from chemically or mechanically damaged accessories.

Even minor scratches and cracks can lead to severe internal material damage.

- ▶ Protect all accessory parts from mechanical damage.
- ▶ Inspect the accessories for damage before each use. Replace any damaged accessories.
- ▶ Do not use any accessories which have exceeded their maximum service life.



CAUTION! Poor safety due to incorrect accessories and spare parts.

The use of accessories and spare parts other than those recommended by Eppendorf may impair the safety, functioning and precision of the device. Eppendorf cannot be held liable or accept any liability for damage resulting from the use of accessories and spare parts other than those recommended or from improper use.

- ▶ Only use accessories and original spare parts recommended by Eppendorf.



NOTICE! Damage to the device due to spilled liquids.

1. Switch off the device.
2. Disconnect the device from the mains/power supply.
3. Carefully clean the device and the accessories in accordance with the cleaning and disinfection instructions in the operating manual.
4. If a different cleaning and disinfecting method is to be used, contact Eppendorf SE to ensure that the intended method will not damage the device.



NOTICE! Damage to electronic components due to condensation.

Condensate may form in the device after it has been moved from a cool environment to a warmer environment.

- ▶ After installing the device, wait for at least 4 h. Only then connect the device to the mains/power line.

2.4.2 Incorrect handling of the centrifuge



NOTICE! Damage from knocking against or moving the device during operation.

If the rotor hits the rotor chamber wall, it will cause considerable damage to the device and rotor.

- ▶ Do not move or knock against the device during operation.
-

2.4.3 Incorrect handling of the rotors



WARNING! Risk of injury from improperly attached rotors and rotor lids.

- ▶ Only centrifuge with the rotor and rotor lid firmly tightened.
 - ▶ If any unusual noises occur when the centrifuge starts, the rotor or the rotor lid may not be attached properly. Stop the centrifugation immediately.
-



CAUTION! Risk of injury due to asymmetric loading of a rotor.

- ▶ Load rotors symmetrically with identical tubes.
 - ▶ Only load adapters with suitable tubes.
 - ▶ Always use the same type of tubes (weight, material/density and volume).
 - ▶ Use a balance to check that the load is symmetrical by balancing the adapters and tubes that are used.
-



CAUTION! Risk of injury from overloaded rotor.

The centrifuge is designed for the centrifugation of material with a maximum density of 1.2 g/mL at maximum speed and filling volume and/or load.

- ▶ Do not exceed the maximum load of the rotor.
-



NOTICE! Damage to rotors from aggressive chemicals.

Rotors are high-quality assemblies designed to withstand extreme stresses. This stability can be impaired by aggressive chemicals.

- ▶ Avoid using aggressive chemicals such as strong and weak alkalis, strong acids, solutions with mercury ions, copper ions and other heavy metal ions, halogenated hydrocarbons, concentrated saline solutions and phenol.
 - ▶ If it is contaminated by aggressive chemicals, clean the rotor and especially the rotor bores immediately using a neutral cleaning agent.
 - ▶ Due to the manufacturing process, color variations may occur on PTFE coated rotors. These color variations do not affect the service life or resistance to chemicals.
-

2.4.4 Extreme strain on the centrifugation tubes



CAUTION! Risk of injury from overloaded tubes.

- ▶ Note the loading limits specified by the tube manufacturer.
 - ▶ Only use tubes which are approved by the manufacturer for the required g -forces (rcf).
-



NOTICE! Danger from damaged tubes.

Damaged tubes must not be used, as this could cause further damage to the device and the accessories and loss of the samples.

- ▶ Visually check all tubes for damage before use.



NOTICE! Danger due to deformed or brittle tubes. Autoclaving at excessively high temperatures can lead to plastic vessels becoming brittle and deformed.

This could result in damage to the device and the accessories and sample loss.

- ▶ Observe the temperatures specified by the manufacturer when autoclaving tubes.
- ▶ Do not use any deformed or brittle tubes.



NOTICE! Danger from open tube lids.

Open tube lids may break off during centrifugation and damage both the rotor and the centrifuge.

- ▶ Carefully seal all tube lids before centrifuging.



NOTICE! Damage to plastic tubes due to organic solvents.

The density of plastic tubes is reduced when organic solvents (e.g. phenol, chloroform) are used, i.e. the tubes may become damaged.

- ▶ Note the manufacturer's information on the chemical resistance of the tubes.





NOTICE! Micro test tubes heat up.

In non-refrigerated centrifuges, the temperature in the rotor chamber, rotor and sample may increase to above 40 °C, depending on the run time, g -force (rcf)/speed and ambient temperature.

- ▶ Please note that this will reduce the centrifugation stability of the micro test tubes.
 - ▶ Please note the temperature resistance of the samples.
-

2.5 Safety instructions on the device and accessories

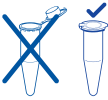
Depiction	Meaning	Location
	NOTICE ▶ Observe the safety instructions in the operating manual.	Right side of the device
	▶ Observe the operating manual.	Right side of the device
	▶ Always tighten the rotor with the enclosed rotor key.	Upper side of the device
	▶ Always close micro test tubes.	Upper side of the device

2.6 Obligation to report accidental damage or damage to the device

As the operator of a medical device, you are obliged to report serious accidents or injuries to persons caused by our device to the following authorities:

- The competent local authorities
- Eppendorf SE
- Your local Eppendorf distributor

2.6.1 Manufacturer Eppendorf SE

Eppendorf SE

Barkhausenweg 1

22339 Hamburg

GERMANY

eppendorf@eppendorf.com

2.6.2 Local Eppendorf distributor

<https://www.eppendorf.com/contact>

3 Product description

3.1 Product overview

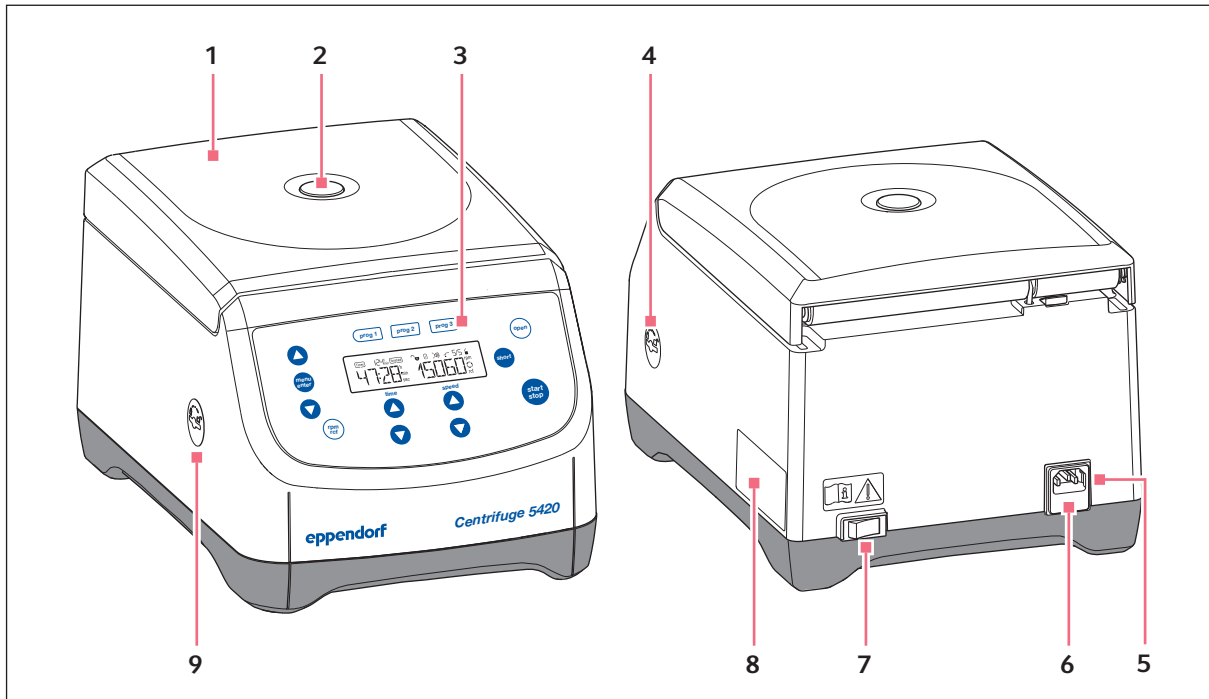

Fig. 3-1: Centrifuge 5420: Front and side view

- | | |
|--|--|
| 1 Centrifuge lid | 6 Fuse holder |
| 2 Monitoring glass
For visual control during rotor stop or speed check using a stroboscope | 7 Mains/power switch
Switch for switching the centrifuge on and off. |
| 3 Control panel
Display and keys for operating the centrifuge | 8 Name plate |
| 4 Interface for software updates
For authorized service personnel only | 9 Emergency release |
| 5 Mains/power cord socket
Connection for the mains/power cord | |

Product description

Centrifuge 5420
English (EN)

3.2 Delivery package

1	Centrifuge 5420
1	Rotor key
1	Mains/power cord
1	Directions
1	Set of fuses



- ▶ Check whether the delivery is complete.
- ▶ Check all parts for transport damage.
- ▶ Keep the transport box and packing material in order to transport and store the device safely.

3.3 Features

The versatile Centrifuge 5420 has a capacity of up to 24 × 2 mL and achieves a maximum of 21300 × *g* or 15060 rpm.

You can select from 2 different rotors to centrifuge the following tubes for various applications:

- Micro test tubes (0.2 mL to 2.0 mL)
- PCR strips
- Microtainers
- Spin columns
- Cryogenic tubes

The centrifuge has 3 program keys for direct selection of user-defined settings and more than 10 different acceleration and braking ramps.

3.4 Name plate

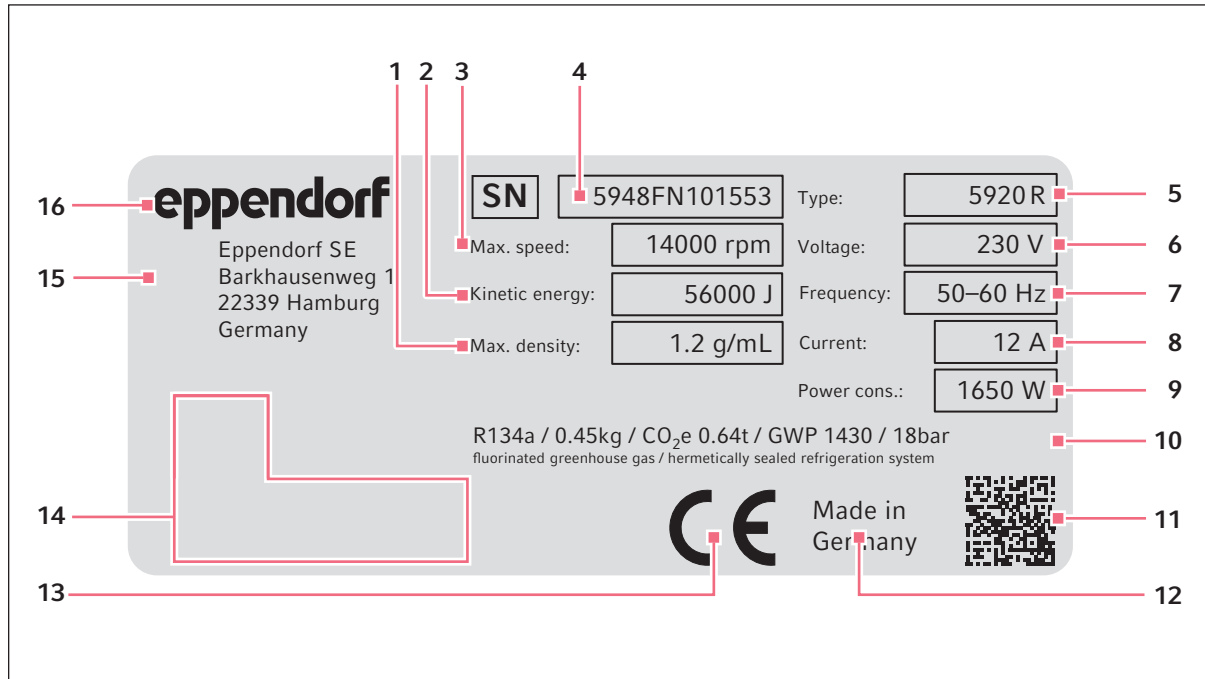









Fig. 3-2: Device identification of Eppendorf SE (example)

- | | |
|---|--|
| 1 Maximum density of the material for centrifuging | 9 Maximum rated power |
| 2 Maximum kinetic energy | 10 Information on the refrigerant (refrigerated centrifuges only) |
| 3 Maximum speed | 11 Data matrix code for serial number |
| 4 Serial number | 12 Designation of origin |
| 5 Product name | 13 CE marking |
| 6 Rated voltage | 14 Certification marks and symbols (device-specific) |
| 7 Rated frequency | 15 Manufacturer's address |
| 8 Maximum rated current | 16 Manufacturer |

Product description

Centrifuge 5420
English (EN)

Tab. 3-1: Certification marks and symbols (device-specific)

Symbol/certification mark	Meaning
	Serial number
	Manufacturer
	Label identifying an in-vitro diagnostic device
	Symbol for waste electrical and electronic equipment (WEEE) according to EU Directive 2012/19/EU, European Community
	UL listing certification mark: Declaration of conformity, USA
	Certification mark for electromagnetic compatibility of the <i>Federal Communications Commission</i> , USA
	Certification mark China – Use of certain hazardous substances in electrical and electronic products (<i>Requirements for Concentration Limits for Certain Hazardous Substances in Electronic Information Products SJ/T 11363-2006</i>), People's Republic of China

4 Installation

4.1 Selecting the location



WARNING! Danger due to incorrect voltage supply.

- ▶ Only connect the device to voltage sources which correspond with the electrical requirements on the name plate.
 - ▶ Only use earth/grounded sockets with a protective earth (PE) conductor.
 - ▶ Only use mains/power cords that are approved for the technical data specified on the name plate and taking into account national laws and regulations. This also includes testing labels if required by law.
-



NOTICE! If a fault occurs, any objects in the immediate proximity of the device will be damaged.

- ▶ In accordance with the recommendations of EN 61010-2-020, leave a safety clearance of **30 cm** around the device during operation.
- ▶ Please remove all materials and objects from this area.



NOTICE! Damage due to overheating.

- ▶ Do not install the device near heat sources (e.g., heating, drying cabinets).
- ▶ Do not expose the device to direct sunlight.
- ▶ Ensure unobstructed air circulation. Maintain a clearance of at least 30 cm around all ventilation gaps.



NOTICE! Radio interference.

For devices with Class A noise emission in accordance with DIN EN 61326-1:2013-07 and DIN EN 55011:2018-05, the following applies: This device has been developed and tested in accordance with CISPR 11 Class A. The device may cause radio interference in domestic environments and is not intended for use in residential areas. The device cannot ensure adequate protection of radio reception in residential areas and domestic environments.

- ▶ If necessary, take appropriate measure to eliminate the interferences.
-



Mains/power connection for centrifuges: Operation of the centrifuge is only permitted in building installations that comply with the applicable national regulations and standards. In particular, it must be ensured that there are no impermissible loads on the supply lines and assemblies that are located upstream of the internal protection of the device. This can be ensured by using additional circuit breakers or other suitable fuse elements in the building installation.



The mains/power switch and the disconnecting device for the mains/power line must be easily accessible during operation (e.g., a residual current circuit breaker).

Select the location for the device according to the following criteria:

- Mains/power connection in accordance with the name plate
 - Minimum distance to other devices and walls: 30 cm
 - A resonance-free table with a horizontal, even work surface
 - The location has good ventilation.
 - The location is protected against direct sunlight.
- ▶ Do not use this device near strong electromagnetic sources (e.g., unshielded high frequency sources) as they could impair the proper operation of the device.

4.2 Preparing installation

The weight of the centrifuge is 12.98 kg.

Unpacking the centrifuge

1. Open the packaging board.
 2. Remove the accessories.
 3. Lift the centrifuge out of the carton.
 4. Place the centrifuge on a suitable lab bench.
 5. Remove the plastic sleeve.
-  The device is delivered with and without a rotor.
The transport securing device can be removed directly from devices without a rotor.
6. Turn the rotor nut **counterclockwise** using the supplied rotor key.
 7. Lift the rotor out vertically.
 8. Remove the transport securing device.

4.3 Installing the instrument

Prerequisites

The device is on a suitable lab bench.



WARNING! Danger due to incorrect voltage supply.

- ▶ Only connect the device to voltage sources which correspond with the electrical requirements on the name plate.
- ▶ Only use earth/grounded sockets with a protective earth (PE) conductor.
- ▶ Only use mains/power cords that are approved for the technical data specified on the name plate and taking into account national laws and regulations. This also includes testing labels if required by law.



NOTICE! Damage to electronic components due to condensation.

Condensate may form in the device after it has been moved from a cool environment to a warmer environment.

- ▶ After installing the device, wait for at least 4 h. Only then connect the device to the mains/power line.

-
1. Let the device warm up to ambient temperature.
 2. Connect the centrifuge to the mains/power line and switch it on at the mains/power switch.
 - The **open** key lights up.
 - The display is active.
 - The lid opens.

5 Operation

5.1 Operating controls

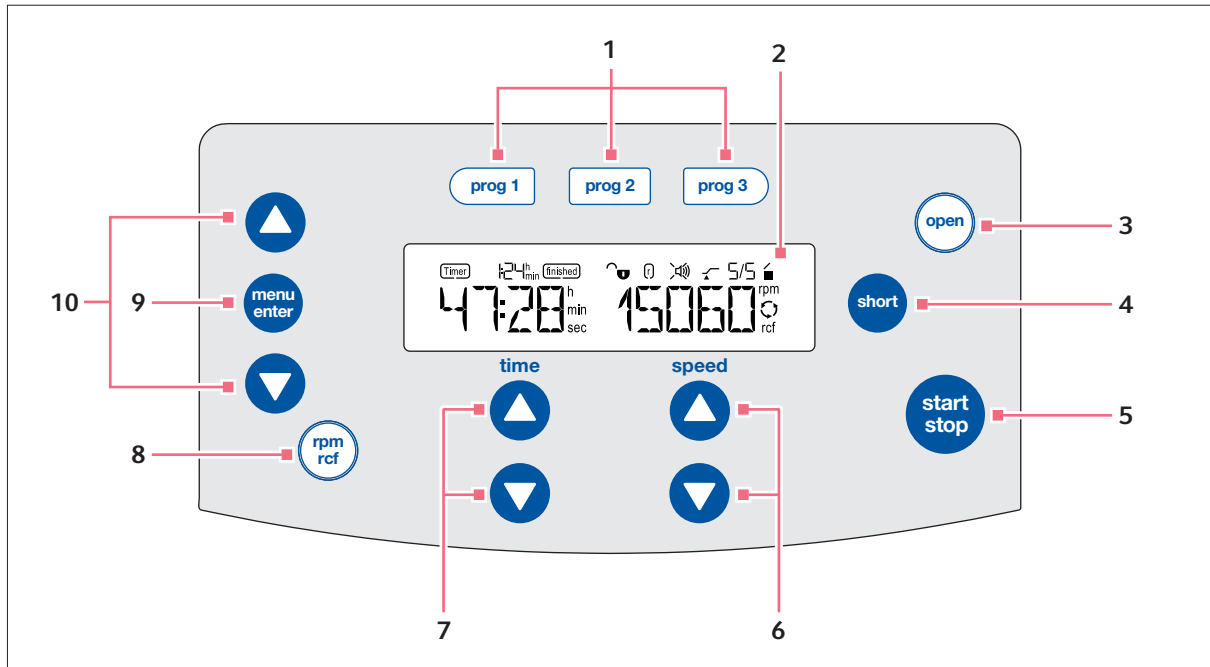

Fig. 5-1: Centrifuge 5420 operating controls

1 Program keys

Pressing the program key: Loading program
Touching and holding the program key for 2 seconds: Saving current parameters

2 Display

3 open key

Releasing the lid

4 short key

Short run centrifugation

5 start/stop key

Starting and stopping centrifugation

6 speed arrow keys

Setting the speed of centrifugation
Touching and holding the arrow key: Quick setting

7 time arrow keys

Setting the centrifugation time
Touching and holding the arrow key: Quick setting

8 rpm/rcf key

Switching the display of the centrifugation speed (to rpm or rcf)

9 menu/enter key

Opening the menu
Confirming your selection

10 Menu arrow keys

Navigating the menu

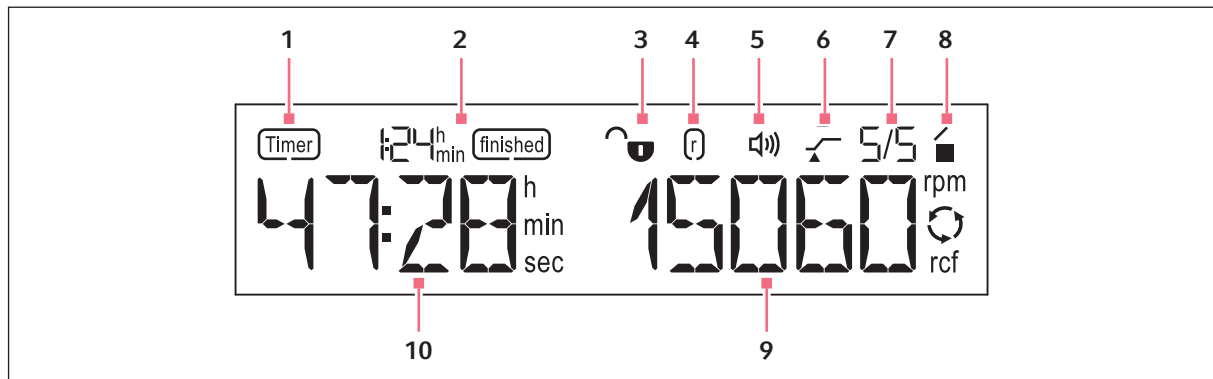











Fig. 5-2: Centrifuge 5420 display

- | | |
|---|--|
| <p>1 Timer function
Timer set: delayed start of the centrifugation run</p> <p>2 finished function
time elapsed since the end of the centrifugation run</p> <p>3 Program lock
 <ul style="list-style-type: none"> 🔒 Program lock activated: program cannot be overwritten. 🔓 Program lock not activated: program settings can be changed and overwritten. </p> <p>4 Radius
This symbol will be displayed if the default radius settings of the rotor have been changed.</p> <p>5 Speaker
 <ul style="list-style-type: none"> 🔊 Speaker switched on. 🔇 Speaker switched off. </p> | <p>6 At set rpm function
 <ul style="list-style-type: none"> 📏: Time counting starts when 95 % of the specified <i>g</i>-force (rcf) or speed (rpm) has been reached. 📏: Time counting begins immediately. </p> <p>7 Ramps
Acceleration ramp and braking ramp, stage 0 to 9</p> <p>8 Centrifuge status
 <ul style="list-style-type: none"> 🔓 Centrifuge lid is unlocked. 🔒 Centrifuge lid is locked. 🔄 (flashing) centrifugation in progress. </p> <p>9 <i>g</i>-force (rcf) or rotational speed (rpm)
Actual value</p> <p>10 Centrifugation time</p> |
|---|--|

5.2 Menu

5.2.1 Navigating the menu

1.		To open the menu, press the menu/enter key.
2.	  	Select the menu item with the menu arrow keys.
3.		To confirm your selection, press the menu/enter key.
4.	  	Change the settings with the menu arrow keys.
5.		To confirm the changed setting, press the menu/enter key.





► In order to leave a menu level, select *BACK* and confirm with the **menu/enter** key.



When the lid is open, the menu can also be left using the **start/stop** key.

5.2.2 Menu structure

Menu items	Description	Symbol on the display
<i>ROTOR</i> menu item	<p>Setting the radius for tube and adapter</p> <ul style="list-style-type: none"> • Selecting the rotor <ul style="list-style-type: none"> – <i>FA-24x2</i> – <i>F-32x0.2-PCR</i> • Selecting the tube volume <ul style="list-style-type: none"> – <i>0_2ML</i> – <i>0_4ML</i> – <i>0_5ML</i> – <i>0_6ML</i> – <i>2_0ML</i> 	
<i>RAMPS</i> menu item	<p>Acceleration ramp and braking ramp</p> <ul style="list-style-type: none"> • Level <i>ACC 9/BRK 9</i>: shortest acceleration time/braking time (setting on delivery) • Level <i>ACC 0/BRK 0</i>: longest acceleration time/braking time <ol style="list-style-type: none"> 1. Select the acceleration ramp (<i>ACCEL</i>) or braking ramp (<i>BRAKE</i>) 2. Select the level 	<i>9/9</i>

Menu items	Description	Symbol on the display
<i>ATSET</i> menu item	<p>Setting the start for time counting</p> <ul style="list-style-type: none"> • <i>OFF</i>: time counting begins immediately (setting on delivery) • <i>ON</i>: time counting starts when 95% of the speed has been reached 	
<i>SHORT</i> menu item	<p>Setting the speed of the short spin centrifugation</p> <ul style="list-style-type: none"> • <i>MAX</i>: Short run centrifugation at the maximum speed of the inserted rotor. • <i>SET</i>: short spin centrifugation at the selected speed 	
<i>TIMER</i> menu item	<p>Setting a start delay for the centrifugation run</p> <ul style="list-style-type: none"> • <i>ON</i>: set the time span up to the start of the centrifugation run • <i>OFF</i>: centrifugation run starts immediately 	
<i>ALARM</i> menu item	<p>Switching the alarm on/off</p> <ul style="list-style-type: none"> • <i>VOL 1 – VOL 5</i>: set the volume of the alarm at the end of the centrifugation run • <i>OFF</i>: no acoustic signal at the end of the centrifugation run 	
<i>LOCK</i> menu item	<p>Switching the write protection for the program on/off</p> <ol style="list-style-type: none"> 1. Select <i>SET PROG</i> 2. Select the program with the prog 1, prog 2 or prog 3 program key 	
<i>SLEEP</i> menu item	<p>Switching Sleep mode on/off</p> <ul style="list-style-type: none"> • <i>ON</i> • <i>OFF</i> 	
<i>LID</i> menu item	<p>Switching automatic opening of the centrifuge lid on/off</p> <ul style="list-style-type: none"> • <i>AUTO</i> • <i>OFF</i> 	

5.3 Switching on the centrifuge

- ▶ Switch the centrifuge on at the mains/power switch.
 - The parameter settings of the last run are displayed.
 - The lid opens.

5.4 Replacing the rotor

5.4.1 Inserting the rotor

1. Place the rotor vertically onto the motor shaft from the top.
2. Insert the supplied rotor key into the rotor nut.
3. Turn the rotor key **clockwise** until the rotor nut is firmly tightened.

5.4.2 Removing the rotor

1. Turn the rotor nut **counterclockwise** using the supplied rotor key.
2. Remove the rotor by lifting it vertically.

5.5 Closing the centrifuge lid

- ▶ Check correct attachment of rotor and rotor lid.
- ▶ Push down the centrifuge lid until the lid latch engages and the lid is automatically closed.

The centrifuge will close automatically.

The **open** key lights up blue. The display shows the ■ symbol.

5.6 Preparing for centrifugation

5.6.1 Loading the rotor



CAUTION! Risk of injury due to asymmetric loading of a rotor.

- ▶ Load rotors symmetrically with identical tubes.
- ▶ Only load adapters with suitable tubes.
- ▶ Always use the same type of tubes (weight, material/density and volume).
- ▶ Use a balance to check that the load is symmetrical by balancing the adapters and tubes that are used.

-
1. Check the maximum payload (adapter, tube and contents) for each rotor bore.
 2. Load rotors and adapters only with the tubes intended for them.

- To ensure symmetrical loading, insert sets of two tubes in opposite bores. Tubes located opposite each other must be of the same type and contain the same filling quantity.

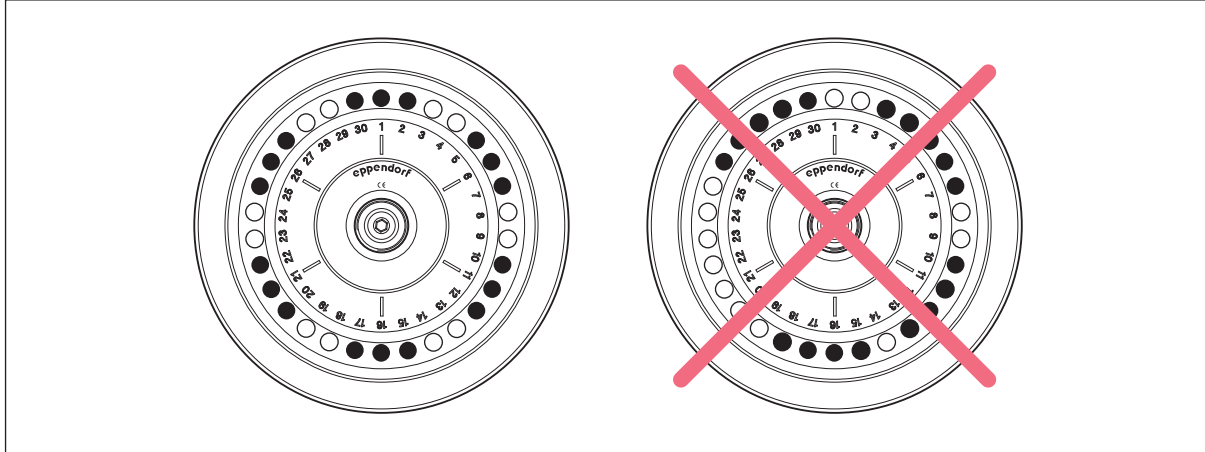

Fig. 5-3: Symmetrical loading of a fixed-angle rotor

To minimize weight differences between filled sample tubes, we recommend balancing with a balance. This will reduce wear on the drive and cut operating noise.

5.6.2 Closing the rotor lid



Use matching rotor lids

- Fixed-angle rotors may only be used with the appropriate rotor lid for the respective rotor. The rotor name on the rotor must correspond to the rotor name on the rotor lid.

- Place the rotor lid vertically on the rotor.
- Turn the rotor lid screw clockwise to seal the rotor.

5.6.3 Closing the rotor lid (aerosol-tight centrifugation)



Identification of aerosol-tight rotors

An aerosol-tight rotor and the matching aerosol-tight rotor lid must be used for aerosol-tight centrifugation.

Aerosol-tight fixed-angle rotor

- Designation begins with **FA**
- Red ring**

Aerosol-tight rotor lid

- Labeled **aerosol-tight**
- Red lid screw**
- Red lid seal**

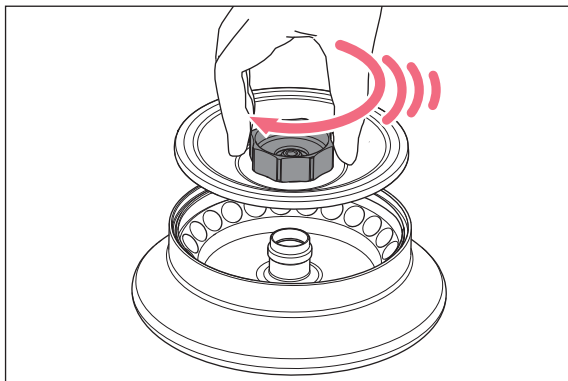

1. Check the correct positioning of the external sealing ring in the groove.
2. Place the rotor lid on the rotor in a vertical motion.
3. Turn the red rotor lid screw clockwise until it stops to seal the rotor.

5.7 Centrifugation

Prerequisites

- The centrifuge is switched on.
- The rotor has been inserted and attached correctly.
- The rotor has been loaded correctly.
- The rotor lid has been mounted correctly.
- The centrifuge lid is closed.



WARNING! Risk of injury from improperly attached rotors and rotor lids.

- ▶ Only centrifuge with the rotor and rotor lid firmly tightened.
- ▶ If any unusual noises occur when the centrifuge starts, the rotor or the rotor lid may not be attached properly. Stop the centrifugation immediately.

5.7.1 Centrifuging with preset time

Setting the centrifugation parameters

1. Set the centrifugation time with the **time** arrow keys.
2. Set the rotational speed (rpm) or *g*-force (rcf) with the **speed** arrow keys.



Switch the centrifugation speed display using the **rpm/rcf** key.

Starting the centrifugation run

3. To start the centrifugation run, press the **start/stop** key.

Display during centrifugation

- The  symbol rotates in the display when the rotor is running.
- Remaining run time in minutes. The last minute is counted down in seconds.
- Current *g*-force (rcf) and/or rotational speed (rpm).



During the run you can change the following parameters:

- Centrifugation time
- Speed: During the run you can switch between the *g*-force and the rotational speed display using the **rpm/rcf** key.

The following keys are blocked during centrifugation:

- **open** key
- **short** key
- **prog 1** to **prog 3** program keys

5.7.2 End of centrifugation

- ▶ Press the **start/stop** key to end centrifugation before the set time.
 - After completion of the set time, the centrifuge stops automatically.
 - During the braking process, the elapsed running time flashes on the display.
 - If the speaker is switched on, a signal sounds when the rotor has stopped.
 -  Time counter after rotor stop: the time from the rotor stop is counted up to 9:59 h on the display. Additionally, ∞ is displayed.
 - *LID > AUTO* setting: the centrifuge lid opens automatically.
 - *LID > OFF* setting – automatic opening of the centrifuge lid is deactivated:
 - The LED of the **open** key flashes.
 - The centrifuge lid remains sealed.
 Press the **open** key to open the lid.

5.7.3 Centrifuging in continuous operation

Setting continuous run

1. In order to centrifuge without any time limits, use the **time** arrow keys to select the setting ∞ (▼ below 10 s or ▲ above 9:59 h).
2. Set the rotational speed (rpm) or *g*-force (rcf) with the **speed** arrow keys.
3. To start the centrifugation run, press the **start/stop** key.
 - The  symbol rotates in the display when the rotor is running.
 - The cycle time is counted up.
 - Current *g*-force (rcf) and/or rotational speed.

5.7.4 Short run centrifugation

All keys are disabled during short run centrifugation except the **start/stop** key.

Setting in the menu item *SHORT*:

- *MAX*: Short run centrifugation at the maximum speed of the inserted rotor.
- *SET*: Short run centrifugation at a freely selected speed.

- ▶ To start a short run centrifugation, press or press and hold the **short** key.

Functions of the **short** key:

- Pressing and holding the **short** key: centrifuge runs for as long as the **short** key is pressed.
- Briefly pressing the **short** key: centrifuge accelerates up to the set speed (*MAX* or *SET*) and then decelerates.

5.7.5 Setting the acceleration ramp and braking ramp

You can set the acceleration and deceleration times in levels from 0 to 9.

- Level 9: shortest acceleration time/deceleration time (default setting).
- Level 0: longest acceleration time/deceleration time.



1. Press the **menu/enter** key. Use the menu arrow keys to select *RAMPS*. Confirm with the **menu/enter** key.
2. Use the ▲ or ▼ menu arrow keys to select *ACCEL* or *BRAKE*. Confirm with the **menu/enter** key.
3. Use the ▲ or ▼ menu arrow keys to select the level. Confirm with the **menu/enter** key.

5.7.6 Setting the start for time counting (*ATSET*)

Prerequisites

- The lid is open.



You can set the start of the time counting via the *ATSET* function:

- Time counting begins immediately: *ATSET > OFF*  (setting on delivery).
- Time counting starts when 95 % of the speed has been reached: *ATSET > ON* 

1. Keep the **start/stop** key pressed.
Symbols that flash can be set.
2. Press and hold the **start/stop** key and press the **speed ▲** arrow key.
Time counting is switched on.
3. Press and hold the **start/stop** key and press the **speed ▼** arrow key.
Time counting is switched off.

5.7.7 Setting the start of the centrifugation run (*TIMER*)

Use the *TIMER* function to delay the start of the centrifugation run, e.g., to bridge an incubation period.

1. Press the **menu/enter** key. Use the menu arrow keys to select *TIMER*. Confirm with the **menu/enter** key.
The  symbol flashes on the display.
2. Select *ON* with the menu arrow keys ◀ or ▶.
3. Use the **time** arrow keys to set the time period until start of the centrifugation run (10 s – 9:59 h).
Confirm with the **menu/enter** key.
A tick appears in front of the selected setting. The setting takes effect immediately. The display switches to the *TIMER* menu item.
 - When the *TIMER* function is activated, the display shows .
 - The settings are effective during the next centrifugation run only. After the centrifugation run, the function is disabled again.

5.7.8 Setting alarms

Prerequisites

The lid is open.

1. Keep the **start/stop** key pressed.
Symbols that flash can be set.
2. Press and hold the **start/stop** key and press the **time ▲** arrow key.
The volume is turned up.
3. Press and hold the **start/stop** key and press the **time ▼** arrow key.
The volume is turned down.

5.8 Aerosol-tight centrifugation



WARNING! Damage to health due to limited aerosol tightness if an incorrect rotor/rotor lid combination is used.

Aerosol-tight centrifugation is only guaranteed if the rotors and rotor lids intended for this purpose are used. The designation of aerosol-tight fixed-angle rotors always starts with **FA**. The aerosol-tight rotors and rotor lids of this centrifuge are also marked with a red ring on the rotor and a red rotor lid screw.

- ▶ Always use rotors and rotor lids marked as aerosol-tight together for aerosol-tight centrifugation. The details specifying in which centrifuge the aerosol-tight rotors and rotor lids may be used can be found on the rotor and on the top of the rotor lid.
- ▶ Only use aerosol-tight rotor lids in combination with the rotors indicated on the rotor lid.



WARNING! Damage to health due to limited aerosol tightness if used incorrectly.

Mechanical stresses and contamination by chemicals or other aggressive solvents may impair the aerosol tightness of the rotors and rotor lids. Autoclaving at excessively high temperatures can lead to plastic vessels, adapters and rotor lids becoming brittle and deformed.

- ▶ Check the integrity of the seals of the aerosol-tight rotor lids or caps before each use.
- ▶ Only use aerosol-tight rotor lids or caps if the seals are undamaged and clean.
- ▶ Do not exceed temperatures of 121 °C or a time of more than 20 min. when autoclaving.
- ▶ After each proper autoclaving process (121 °C, 20 min.), coat the threads of the rotor lid screw with a thin layer of pivot grease (order no. Int. 5810 350.050, North America 022634330).
- ▶ On aerosol-tight rotor lids with exchangeable seals, the seal must be replaced after 50 autoclaving cycles.
- ▶ **Never** close aerosol-tight rotors or buckets for storage.



The aerosol tightness of rotors, rotor lids, buckets and caps has been tested and certified according to Annex AA of IEC 61010-2-020.

5.9 Switching off the centrifuge

1. Open the centrifuge lid.
Residual moisture can evaporate.
2. Remove rotor lids from fixed-angle rotors.
Aerosol-tight accessories may not be stored with the lid closed.
3. Switch off the centrifuge using the mains/power switch.

6 Programs

6.1 Creating a new program

The Centrifuge 5420 has more than 3 programmable memory locations.

Apart from the parameters centrifugation time and speed, you can define the settings for the following options separately for each program:

Adjusting the radius for the vessel used	<i>ROTOR</i> menu item
Acceleration ramp	<i>RAMPS > ACCEL</i> menu item
Braking ramp	<i>RAMPS > BRAKE</i> menu item
Setting start of time counting	<i>ATSET</i> menu item
Delaying the start of the centrifugation run	<i>TIMER</i> menu item
Adding write protection to a program	<i>LOCK</i> menu item

6.1.1 Saving a program

1. Set the centrifugation time with the **time** arrow keys.
2. Set the rotational speed (rpm) or *g*-force (rcf) with the **speed** arrow keys.

Defining additional options of the program

3. Open the menu using the **menu/enter** key.
4. Select an option, for instance, *ATSET*, with the menu arrow keys ◀ or ▶. Confirm with the **menu/enter** key.
5. Change the setting with the ▲ or ▼ menu arrow keys. Confirm with the **menu/enter** key.

Saving a program

6. Keep one of the program keys **prog 1** to **prog 3** pressed for 2 seconds.
 - The program key lights up in blue.
 - The parameters of the program are saved.

6.1.2 Adding write protection to a program

1. Open the menu using the **menu/enter** key.
2. Select *LOCK* with the menu arrow keys ◀ or ▶. Confirm with the **menu/enter** key.
 - The display shows *SET PROG*.
 - The  symbol flashes on the display.
3. Press one of the program keys **prog 1** to **prog 3**.
The program key lights up in blue.
4. Confirm with the program key of the protected program.
The display switches to the *LOCK* menu item.
5. In order to leave the menu, select *BACK* and confirm with **menu/enter**.

6.2 Loading a saved program

6.2.1 Loading program prog 1 to prog 3

1. To call up a program, press one of the program keys **prog 1 to prog 3**.
 - The program key lights up in blue.
 - The display shows the parameters of the program.
2. Start the program: press the **start/stop** key.

6.3 Overwriting programs

The programs can not be deleted. All parameters of a program can be changed and overwritten.

6.3.1 Removing the write protection of programs

1. Open the menu using the **menu/enter** key.
2. Select *LOCK* with the menu arrow keys ◀ or ▶. Confirm with the **menu/enter** key.
 - The display shows *SET PROG*.
 - The  symbol flashes on the display.
 - The program keys of write-protected programs light up in blue.
3. Press an illuminated program key.
 - The light of the program key goes off.
 - The write-protection of the program is removed.
4. Confirm with the **menu/enter** key.

The display switches to the *LOCK* menu item.
5. In order to leave the menu, select *BACK* and confirm with **menu/enter**.

6.3.2 Editing programs

Prerequisites

The write protection of the program is removed

1. To select a program, press the program keys **prog 1 to prog 3**.
 - The program key lights up in blue.
 - The display shows the parameters of the program.
2. Change parameters and options .

The light of the program key goes off.
3. To save the changed parameters, press the program key for 2 seconds.
 - The program key lights up in blue.
 - The parameters of the program are saved.

7 Device settings

7.1 Setting alarms

You can set the volume of the acoustic signal after completion of the centrifugation run.

7.1.1 Activating the alarm

1. Press the **menu/enter** key. Use the menu arrow keys to select *ALARM*. Confirm with the **menu/enter** key.
The 🔔 symbol flashes on the display.
2. To set the volume of the acoustic alarm use the menu arrow keys ▲ or ▼ to select *VOL 1 – VOL 5*. Confirm with the **menu/enter** key.
A tick appears in front of the selected setting. The setting takes effect immediately. The display switches to the *ALARM* menu item.
3. In order to leave the menu, select *BACK* and confirm with **menu/enter**.

The display shows 🔔.

7.1.2 Deactivating the alarm

1. Press the **menu/enter** key. Use the menu arrow keys to select *ALARM*. Confirm with the **menu/enter** key.
The 🔔 symbol flashes on the display.
2. Select *OFF* with the menu arrow keys ◀ or ▶. Confirm with the **menu/enter** key.
A tick appears in front of the selected setting. The setting takes effect immediately. The display switches to the *ALARM* menu item.
3. In order to leave the menu, select *BACK* and confirm with **menu/enter**.

The display shows 🔕.

7.2 Sleep mode

In sleep mode the display shows *EP*, if the centrifuge has not been used for more than 15 minutes. To reactivate the display, press a key or close the centrifuge lid.

7.2.1 Activating the sleep mode

1. Press the **menu/enter** key. Use the menu arrow keys to select *SLEEP*. Confirm with the **menu/enter** key.
2. Use the menu arrow keys to select *ON*. Confirm with the **menu/enter** key.
A tick appears in front of the selected setting. The setting takes effect immediately. The display switches to the *SLEEP* menu item.
3. In order to leave the menu, select *BACK* and confirm with **menu/enter**.

7.2.2 Deactivating the sleep mode

1. Press the **menu/enter** key. Use the menu arrow keys to select *SLEEP*. Confirm with the **menu/enter** key.
2. Use the menu arrow keys to select *OFF*. Confirm with the **menu/enter** key.

A tick appears in front of the selected setting. The setting takes effect immediately. The display switches to the *SLEEP* menu item.

3. In order to leave the menu, select *BACK* and confirm with **menu/enter**.

7.3 Automatic lid opening

You can set whether you want the centrifuge lid to open automatically after completion of a centrifugation run or to remain closed.

7.3.1 Activating automatic lid opening

1. Press the **menu/enter** key. Use the menu arrow keys to select *LID*. Confirm with the **menu/enter** key.
2. Use the menu arrow keys to select *AUTO*. Confirm with the **menu/enter** key.

A tick appears in front of the selected setting. The setting takes effect immediately. The display switches to the *LID* menu item.

3. In order to leave the menu, select *BACK* and confirm with **menu/enter**.

7.3.2 Deactivating automatic lid opening

1. Press the **menu/enter** key. Use the menu arrow keys to select *LID*. Confirm with the **menu/enter** key.
2. Use the menu arrow keys to select *OFF*. Confirm with the **menu/enter** key.

A tick appears in front of the selected setting. The setting takes effect immediately. The display switches to the *LID* menu item.

3. In order to leave the menu, select *BACK* and confirm with **menu/enter**.

If automatic lid opening is deactivated, the centrifuge lid is opened via the **open** key.

8 Maintenance

8.1 Service options

Eppendorf recommends having your device checked and maintained by trained specialist personnel at regular intervals.

Eppendorf offers you tailor-made service solutions for the preventive maintenance, qualification and calibration of your device. For information, offers and contact options, please visit www.eppendorf.com/epservices.

8.2 Service



WARNING! Risk of fire or electrical shock

- ▶ Have the centrifuge's electrical safety, especially the continuity of the protective connections, checked every 12 months by trained and skilled personnel.

8.3 Prepare cleaning/disinfection

- ▶ Clean all accessible surfaces of the device and the accessories at least weekly and when contaminated.
- ▶ Clean the rotor regularly. This way the rotor is protected and the durability is prolonged.
- ▶ Furthermore, observe the notes on decontamination (see *Decontamination before shipment on p. 44*) when the device is sent to the authorized Technical Service for repairs.

The procedure described in the following chapter applies to the cleaning as well as to the disinfection or decontamination. The table below describes the steps required on top of this:

Cleaning	Disinfection/decontamination
<ol style="list-style-type: none"> 1. Use a mild cleaning fluid to clean the accessible surfaces of the device and the accessories. 2. Carry out the cleaning as described in the following chapter. 	<ol style="list-style-type: none"> 1. Choose the disinfection method which corresponds to the legal regulations and guidelines in place for your range of application. For example, use alcohol (ethanol, isopropanol) or alcohol-based disinfectants. 2. Carry out the disinfection or decontamination as described in the following chapter. 3. Then clean the device and the accessories.



If you have any further questions regarding cleaning and disinfection or decontamination or regarding the cleaning agents to be used, contact the Application Support of Eppendorf SE. The contact details are provided on the back of this manual.

8.4 Performing cleaning/disinfection



DANGER! Electric shock due to the ingress of liquid.

- ▶ Switch off the device and disconnect it from the mains/power line before commencing any cleaning or disinfection procedures.
- ▶ Do not allow any liquids to enter the inside of the housing.
- ▶ Do not spray clean or spray disinfect the housing.
- ▶ Do not reconnect the device to the mains/power line unless both the inside and outside of the device are completely dry.



WARNING! Damage to health due to limited aerosol tightness if used incorrectly.

Mechanical stresses and contamination by chemicals or other aggressive solvents may impair the aerosol tightness of the rotors and rotor lids. Autoclaving at excessively high temperatures can lead to plastic tubes, adapters and rotor lids becoming brittle and deformed.

- ▶ Check the integrity of the seals of the aerosol-tight rotor lids or caps before each use.
- ▶ Only use aerosol-tight rotor lids or caps if the seals are undamaged and clean.
- ▶ Do not exceed temperatures of 121 °C or a time of more than 20 min. when autoclaving.
- ▶ After each proper autoclaving process (121 °C, 20 min.), coat the threads of the rotor lid screw with a thin layer of pivot grease (order no. Int. 5810 350.050, North America 022634330).
- ▶ On aerosol-tight rotor lids with exchangeable seals (e.g. QuickLock rotor lids) the seal only needs to be replaced after 50 autoclaving cycles.
- ▶ **Never** close aerosol-tight rotors or buckets for storage.



NOTICE! Damage due to aggressive chemicals.

- ▶ Do not use any aggressive chemicals on the device or its accessories, such as strong and weak bases, strong acids, acetone, formaldehyde, halogenated hydrocarbons or phenol.
- ▶ If the device has been contaminated by aggressive chemicals, clean it immediately using a mild cleaning agent.



NOTICE! Corrosion due to aggressive cleaning agents and disinfectants.

- ▶ Do not use any corrosive cleaning agents, aggressive solvents or abrasive polishes.
- ▶ Do not incubate the accessories in aggressive cleaning agents or disinfectants for longer periods.



NOTICE! Damage from UV and other high-energy radiation.

- ▶ Do not use UV, beta or gamma rays, or any other high-energy forms of radiation for disinfection.
- ▶ Avoid storage in areas with high UV radiation.



Autoclaving

Rotors, rotor lids and adapters can be autoclaved (121 °C, 20 min).
Replace the seal on aerosol-tight rotor lids after 50 autoclaving cycles.



Aerosol tightness

Check that the seals are intact before use.
Replace the rotor lids with screw cap when the sealing rings on the lid screw and in the lid groove become worn.
Regular care of the sealing rings is necessary in order to protect the rotors.
Aerosol-tight rotors should never be stored with the lids screwed on!
In order to prevent damage, lightly grease the lid threads of aerosol-tight rotors regularly with pivot grease (order no. int.: 5810 350.050/North America: 022634330).

8.4.1 Cleaning and disinfecting the device

1. Open the lid. Switch the device off at the mains/power switch. Disconnect the mains/power plug from the voltage supply.
2. Loosen the rotor nut by turning it counterclockwise with the rotor key.
3. Remove the rotor.
4. Clean and disinfect all accessible surfaces on the device including the mains/power cord using a damp cloth and the recommended cleaning agents.
5. Thoroughly clean the rubber seal of the rotor chamber with water.
6. Rub the dry rubber seal with, for example, glycerol to prevent it from becoming brittle. Other components of the device, such as the motor shaft and the rotor cone, must not be lubricated.
7. Clean the motor shaft with a soft, dry, lint-free cloth. Do not grease the motor shaft.
8. Inspect the motor shaft for damage.
9. Inspect the device for corrosion and damage.
10. Leave the centrifuge lid open when the device is not being used.
11. Only reconnect the device to the mains/power supply if it is fully dry on the inside and outside.

8.4.2 Cleaning and disinfecting the rotor

1. Inspect the rotor and accessories for damage and corrosion. Do not use any damaged rotors or accessories.
2. Clean and disinfect the rotors and accessories with the recommended cleaning agents.
3. Clean and disinfect the rotor bores with a bottle brush.
4. Rinse the rotors and accessories thoroughly with distilled water. Rinse the rotor bores of fixed-angle rotors particularly thoroughly.



Do not immerse the rotor in liquid as liquid can enter through the openings when doing so.

5. Place the rotors on a towel to dry. Place fixed-angle rotors with the rotor bores facing down so the bores can also dry.
6. Clean the rotor cone with a soft, dry, lint-free cloth. Do not lubricate the rotor cone.
7. Inspect the rotor cone for damage.
8. Place the dry rotor onto the motor shaft.
9. Tighten the rotor nut by turning it **clockwise**.
10. Leave the rotor lid open when the rotor is not being used.

8.4.3 Cleaning the rotor lid and replacing the seal

Prerequisites

The rotor lid has been removed.

Recommended cleaning agents:

- Alcohol 70 % (ethanol, isopropanol)
- Mild neutral cleaning agent

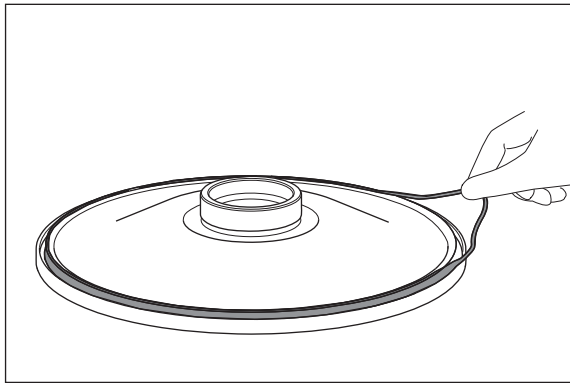

1. Remove the sealing ring to thoroughly clean the groove below it.
2. Clean and disinfect the rotor lid using the recommended cleaning agents.
3. Rinse the rotor lid thoroughly with distilled water.
4. Moisten the new sealing ring with clean water.

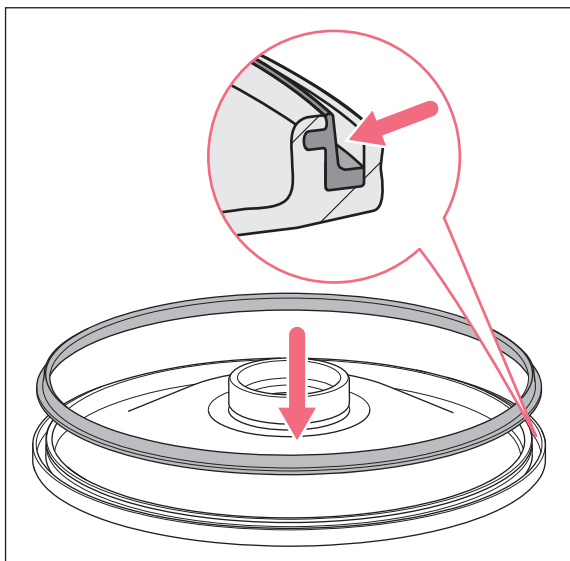

5. Insert the sealing ring into the clean groove of the rotor lid.
6. Press the sealing ring into the lateral groove, around the entire circumference of the rotor lid.
7. Place the rotor lid with the underside facing upwards on a cloth.
8. Leave the rotor lid to dry for 5 –10 minutes.
9. Perform a visual inspection.
The seal must be flush with the groove of the rotor lid around the entire circumference and must not protrude at any point.
10. Fit the rotor lid on the rotor.
11. Leave the rotor lid open when the rotor is not being used.



The rotor lid cannot close properly if the sealing ring is not correctly inserted.

8.5 Cleaning glass breakage

When using glass tubes there is a risk of glass breakage in the rotor chamber. The resulting glass splinters are swirled around in the rotor chamber during centrifugation and have a sandblasting effect on the rotor and accessories. Very small particles of glass can become lodged in the rubber parts (e.g., the motor sleeve, the rotor chamber seal, and the rubber mats of adapters).



NOTICE! Glass breakage in the rotor chamber

Glass tubes in the rotor chamber may break if the *g*-force is too high. Broken glass can damage the rotor, accessories and samples.

- ▶ Please note the manufacturer's information on the recommended centrifugation parameters (load and speed).
-

Effects of glass breakage in the rotor chamber:

- Fine black metal abrasion dust in the rotor chamber (with metal rotor bowls).
- The surfaces of the rotor chamber and accessories are scratched.
- The chemical resistance of the rotor chamber is reduced.
- Contamination of samples.
- Wear on rubber parts.

How to proceed in case of glass breakage

1. Remove all splinters and glass powder from the rotor chamber and accessories.
2. Thoroughly clean the rotor and rotor chamber. Thoroughly clean the bores of the fixed-angle rotors, in particular.
3. Regularly check the rotor bores for deposits and damage.

8.6 Replacing fuses

The fuse holder is located under the mains power socket.

1. Disconnect the mains/power plug.
2. Remove the fuse holder.
3. Replace faulty fuses and reinsert the fuse holder.

8.7 Decontamination before shipment

If you are shipping the device to the authorized Technical Service for repairs or to your authorized dealer for disposal please note the following:



WARNING! Risk to health from contaminated device.

1. Observe the information contained in the decontamination certificate. It is available as a PDF document on our webpage (<https://www.eppendorf.com/decontamination>).
 2. Decontaminate all parts to be shipped.
 3. Include the fully completed decontamination certificate in the shipment.
-

9 Troubleshooting

If you cannot remedy an error with the recommended measures, please contact your local Eppendorf partner. The contact address can be found on the Internet at www.eppendorf.com.

9.1 General errors

Problem	Cause	Solution
No display.	No mains/power connection.	▶ Check the mains/power connection.
	Mains/power outage.	▶ Check the fuse of the device. ▶ Check the mains/power fuse of the lab.
Centrifuge lid cannot be opened.	The rotor is still running.	▶ Wait for the rotor to stop.
	Mains/power outage.	1. Check the fuse of the device. 2. Check the mains/power fuse of the lab. 3. Actuate the emergency release.
Centrifuge cannot be started.	The centrifuge lid is not closed.	▶ Close the centrifuge lid.
Centrifuge shakes when it starts up.	The rotor is loaded asymmetrically.	1. Stop the centrifuge and load the rotor symmetrically. 2. Restart the centrifuge.

9.2 Error messages

If an error message appears, proceed as follows:

1. Remedy the fault as described in the "Remedy" column.
2. To clear the error message from the display, press the **open** key.
3. If necessary, repeat centrifugation.

TroubleshootingCentrifuge 5420
English (EN)

Problem	Cause	Solution
<i>IMBAL</i>	The rotor is loaded asymmetrically.	▶ Load the rotor symmetrically and balance it.
<i>NET INT</i>	Mains/power failure during a run.	▶ Check the mains/power supply.
<i>LID ERROR</i>	Centrifuge lid cannot be locked.	▶ Try to close the centrifuge lid again.
	Centrifuge lid cannot be released.	1. Switch off the centrifuge and wait for 20 s. 2. Switch on the centrifuge. If the error occurs again: 1. Switch off the centrifuge. 2. Activate the emergency lid release.
	Prohibited opening of lid during a run or lid switch defective	1. Wait for the rotor to stop. 2. Open the centrifuge lid and then close it again. 3. Repeat the run.
<i>LID LIFT</i>	The centrifuge lid has not been opened wide enough.	▶ Open the centrifuge lid wider by hand.
<i>NO RPM</i>	Error in the rotational speed measurement system	▶ Leave the device switched on until the rotor stops and the error message disappears (up to 15 min).
<i>Fix Rotor / No Rotor</i>	Rotor detection error	▶ Open the centrifuge and check if the rotor has been properly inserted and tightened. Close and restart the centrifuge.
<i>ERROR 6</i>	Error in the drive electronics	▶ Repeat the run. If the error message appears again: 1. Switch off the centrifuge and wait for 20 s. 2. Switch on the centrifuge.
<i>ERROR 7</i>	Deviation in the speed check.	1. Wait for the rotor to stop. 2. Tighten the rotor.
<i>ERROR 10</i>	Error during initialization or in the memory	1. Switch off the centrifuge and wait for 20 s. 2. Switch on the centrifuge.
<i>ERROR 16</i>	Data communication error with the motor	1. Switch off the centrifuge and wait for 20 s. 2. Switch on the centrifuge.
<i>ERROR 20</i>	Drive overheated	▶ Allow the drive to cool down for at least 15 min.
<i>ERROR 26</i>	Data communication error with the motor	1. Switch off the centrifuge and wait for 20 s. 2. Switch on the centrifuge.
<i>ERROR 27</i>	Electronics fault	1. Switch off the centrifuge and wait for 20 s. 2. Switch on the centrifuge.

9.3 Emergency release



WARNING! Risk of injury from rotating rotor.

If the emergency release of the lid is operated, the rotor may continue to rotate for several minutes.

- ▶ Wait for the rotor to stop before activating the emergency release.
 - ▶ To check, look through the monitoring glass in the centrifuge lid.
-

If the centrifuge lid does not open, you can open it manually using the emergency release.



Use the rotor key to operate the emergency release.

1. Disconnect the mains/power plug.
2. Remove the plastic cover of the emergency release on the left side of the device.
Turn the plastic cover 90° **clockwise** using the rotor key and remove it.
3. Insert the centrifuge rotor key into the hexagonal opening behind the plastic cover until a noticeable resistance is felt.
4. Turn the rotor key **counterclockwise**.
This will release the centrifuge lid.
5. Open the centrifuge lid.
6. Remove the rotor key and reattach the plastic cover.
Turn the plastic cover 90° **counterclockwise** using the rotor key.

10 Transport, storage and disposal

10.1 Transport

- ▶ Remove the rotor from the centrifuge before transport.
- ▶ Use the original packaging and the transport securing devices for transport.

	Air temperature	Relative humidity	Atmospheric pressure
General transport	-25°C – 60 °C	10 % – 75 %	30 kPa – 106 kPa
Air freight	-20°C – 55 °C	10 % – 75 %	30 kPa – 106 kPa

10.2 Storage

	Air temperature	Relative humidity	Atmospheric pressure
In transport packing	-25°C – 55 °C	10 % – 75 %	70 kPa – 106 kPa
Without transport packing	-5°C – 45°C	10 % – 75 %	70 kPa – 106 kPa

10.3 Disposal

Observe the relevant legal regulations when disposing of the product.

Information on the disposal of electrical and electronic devices in the European Community:

Within the European Community, the disposal of electrical devices is regulated by national regulations based on EU Directive 2012/19/EU pertaining to waste electrical and electronic equipment (WEEE).

According to these regulations, any devices supplied after August 13, 2005, in the business-to-business sphere, to which this product is assigned, may no longer be disposed of in municipal or domestic waste. They are marked with the following symbol to indicate this:

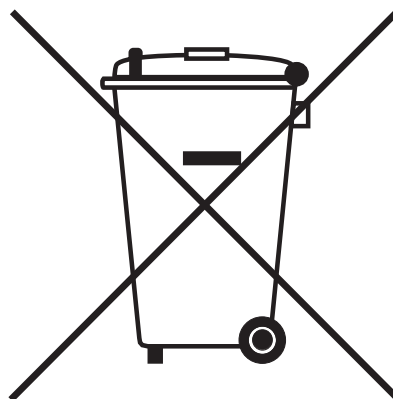

As the disposal regulations may differ from one country to another within the EU, please contact your supplier for more information.

11 Technical data

11.1 Power supply

Centrifuge 5420

Mains/power connection	230 V, 50 Hz – 60 Hz 120 V, 50 Hz – 60 Hz 100 V, 50 Hz – 60 Hz
Current consumption	230 V: 2.1 A 120 V: 4.0 A 100 V: 4.2 A
Power consumption	230 V: 290 W 120 V: 270 W 100 V: 250 W
EMC: noise emission (radio interference)	230 V – EN 61326-1/EN 55011 – Class B 120 V – CFR 47 FCC Part 15 – Class B 100 V – EN 61326 – 1/EN 55011 – Class B
EMC: noise immunity	EN 61326-1 – basic electromagnetic environment
Overvoltage category	II
Protection class	I
Fuses – 230 V	250 V 4 A T HBC
Fuses – 120 V	250 V 8 A T HBC
Fuses – 100 V	250 V 8 A T HBC
Degree of pollution	2

11.2 Ambient conditions

Environment	For indoor use only. The surroundings must not be moist.
Ambient temperature	2 °C – 40 °C
Relative humidity	10 % – 75 %, non-condensing.
Atmospheric pressure	75 kPa – 106 kPa

11.3 Weight/dimensions

Dimensions	Width: 24.2 cm Depth: 34.6 cm Height: 21.5 cm
Weight without rotor	12.98 kg
Rotor weights:	
FA-24x2	772 g
F-32x0.2-PCR	460 g

11.4 Noise level

The noise level was measured in a sound measuring room with accuracy class 1 (DIN EN ISO 3745), frontally, at a distance of 1 m from the device and at lab bench height.

Noise level	< 56 dB(A)
-------------	------------

11.5 Application parameters

The following table contains acceleration times and deceleration times for the rotors of the Centrifuge 5420. The details were determined with the rotor at maximum load, for swing-bucket rotors with round bucket. Fluctuations may occur depending on the condition of the device and the load.

Tab. 11-1: Acceleration and deceleration time

Rotor	Acceleration time	Deceleration time
FA-24x2	15 s	15 s
F-32x0.2-PCR	15 s	15 s

Run time	10 s – 9:59 h, unlimited (∞) • 10 s – 2 min: can be set in increments of 10 s • 2 min – 10 min: can be set in increments of 30 s • 10 min – 9:59 h: can be set in increments of 1 min
Speed	100 rpm – 15060 rpm • 100 rpm – 5000 rpm: can be set in increments of 10 rpm • 5000 rpm – 15060 rpm: can be set in increments of 100 rpm
Relative centrifugal force	$1 \times g$ – $21300 \times g$ • $1 \times g$ – $3000 \times g$: can be set in increments of $10 \times g$ • $5000 \times g$ – $21300 \times g$: can be set in increments of $100 \times g$
Maximum load	Fixed-angle rotor: 24×2 mL
Maximum kinetic energy	4.09 kJ
Permitted density of the material for centrifuging (at maximum g -force (rcf) or rotational speed (rpm) and maximum load)	1.2 g/mL
Inspection obligation in Germany	No

11.6 Service life of accessories



CAUTION! Danger due to material fatigue.

If the service life is exceeded, it cannot be guaranteed that the material of the rotors and the accessories will withstand the stresses during centrifugation.

- ▶ Do not use any accessories which have exceeded their maximum service life.

All rotors and rotor lids can be used during the entire service life of the centrifuge if the following conditions are met:

- proper use
- recommended maintenance
- undamaged condition

Accessories	Maximum service life after initial setup	
Aerosol-tight rotor lid		3 years
Seals in the aerosol-tight rotor lid	50 autoclaving cycles	–
Adapter	–	1 year

The date of manufacture is stamped on the rotors and buckets in the format *2015-03* (= March 2015).

12 Rotors for the Centrifuge 5420



Eppendorf centrifuges may only be operated with rotors that are intended for use with the corresponding centrifuge.

- ▶ Only use rotors that are intended for use with the corresponding centrifuge.







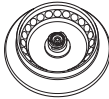

Only use rotors labeled **Centrifuge 5420**.

Please note the manufacturer's information on the centrifugation stability of the sample tubes used (maximum *g-force*).

12.1 Rotor FA-24x2

Aerosol-tight fixed-angle rotor for 24 tubes

	Max. <i>g-force</i> :	21300 × <i>g</i>
	Max. rotational speed:	15060 rpm
Rotor FA-24x2	Max. load (adapter, tube and contents):	24 × 3.75 g

Tube	Tube Capacity Tubes per adapter/ rotor	Adapter Order no. (international)	Bottom shape Diameter	Max. <i>g-force</i> Max. rotational speed Radius
	PCR tube 0.2 mL 1/24	 5425 715.005	conical Ø 6 mm	15975 × <i>g</i> 15060 rpm 6.3 cm
	Micro test tube 0.4 mL 1/24	 5425 717.008	conical Ø 6 mm	21300 × <i>g</i> 15060 rpm 8.4 cm
	Micro test tube 0.5 mL 1/24	 5425 716.001	– Ø 8 mm	18510 × <i>g</i> 15060 rpm 7.3 cm
	Microtainers 0.6 mL 1/24	 5425 716.001	– Ø 8 mm	21300 × <i>g</i> 15060 rpm 8.4 cm
	Micro test tube 1.5 mL/2 mL –/24	–	conical Ø 11 mm	21300 × <i>g</i> 15060 rpm 8.4 cm

Rotors for the Centrifuge 5420



Centrifuge 5420

English (EN)

12.2 Rotor F-32x0.2-PCR

Fixed-angle rotor for PCR strips and PCR tubes

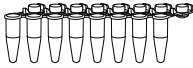
	Max. <i>g</i> -force:	18257 × <i>g</i>
	Max. rotational speed:	15060 rpm
Rotor F-32x0.2-PCR	Max. load (tube and contents):	32 × 3.5 g

Tube	Tube Capacity Vessels per rotor	Bottom shape Diameter	Max. <i>g</i> -force
			Max. rotational speed
			Radius
	PCR strips 8 × 0.2 mL or 5 × 0.2 mL 4 × 8 or 4 × 5	Conical Ø 6 mm	18257 × <i>g</i> 15257 rpm 7.2 cm
	PCR tube 0.2 mL 32	Conical Ø 6 mm	18257 × <i>g</i> 15257 rpm 7.2 cm

13 Ordering Information

Order no. (International)	Description
5495 400.001	Rotor FA-24x2 aerosol-tight, 24 × 1.5/2 mL tubes incl. aerosol-tight rotor lid, Centrifuge 5420
5495 515.003	Seal for rotor lid FA-24x2 (Centrifuge 5420, 5425/R)
5495 401.008	Rotor lid FA-24x2 aerosol-tight, aluminum
5495 404.007	Rotor F-32x0.2-PCR 32 × 0.2 mL PCR tubes or 4 × 8 PCR tube strips incl. rotor lid, Centrifuge 5420
5495 511.008	Rotor lid F-32x0.2-PCR aluminum
5425 716.001	Adapter used in FA-45-48-11, FA-45-30-11, F-45-30-11, F-45-48-11, F-45-70-11, FA-45-24-11, FA-45-24-11-Special, FA-45-24-11-HS and FA-45-24-11-Kit for 1 sample tube (0.5 mL, max. Ø 6 mm) or 1 Microtainer (0.6 mL, max. Ø 8 mm), set of 6
5425 717.008	Adapter used in FA-45-48-11, F-45-12-11, FA-45-18-11, FA-45-30-11, F-45-30-11, F-45-24-11, F-45-70-11, FA-45-24-11-HS, FA-45-24-11-Kit and S-24-11-AT for 1 micro test tube (0.4 mL, max. Ø 6 mm), set of 6
5425 715.005	Adapter used in FA-45-48-11, F-45-48-11, FA-45-30-11, F-45-30-11, F-45-24-11, F-45-70-11, FA-45-24-11, FA-45-24-11-Special, FA-45-24-11-HS and FA-45-24-11-Kit for 1 PCR tube (0.2 mL, max. Ø 6 mm), set of 6
5301 850.249	Fuse 4.0 A T (230 V), 2 pieces
5427 850.341	8.0 A T (120 V, 100 V), 2 pieces
5416 301.001	Rotor key Standard

Ordering Information

Centrifuge 5420

English (EN)

Declaration of Conformity

The product named below fulfills the requirements of directives and standards listed. In the case of unauthorized modifications to the product or an unintended use this declaration becomes invalid. This declaration of conformity is issued under the sole responsibility of the manufacturer.

Product name:

Centrifuge 5420

including components

Product type:

Centrifuge

Relevant directives / standards:

2017/746/EU: DIN EN ISO 13485, DIN EN ISO 18113-1, DIN EN ISO 18113-3, DIN EN ISO 15223-1, DIN EN ISO 14971, DIN EN 61010-2-101, DIN EN 61326-2-6, DIN EN 62366-1

2014/35/EU: DIN EN 61010-1, DIN EN 61010-2-020

2014/30/EU: DIN EN 61326-1, DIN EN 55011

2011/65/EU: DIN EN IEC 63000
(incl. (EU) 2015/863)

Further applied standards: IEC 61010-1 + Cor. + A1 + A1/Cor.1, IEC 61010-2-020, IEC 61010-2-101
UL 61010-1, UL 61010-2-020
CAN/CSA C22.2 No. 61010-1-12, CAN/CSA C22.2 No. 61010-2-020
IEC 61326-1, CISPR 11 + A1, 47 CFR FCC part 15
YY/T 0657, GB 4793.1, GB 4793.7, GB 18268.1, YY/T 0466.1, SJ/T 11364,
GB/T 26572

Basic UDI-DI: 04043758-IA-CEN-008-PD

Hamburg, November 09, 2021



Dr. Wilhelm Plüster
Management Board



Dr. Marlene Jentzsch
Senior Vice President
Division Separation & Instrumentation

Your local distributor: www.eppendorf.com/contact
Eppendorf SE · Barkhausenweg 1 · 22339 Hamburg · Germany
eppendorf@eppendorf.com

Eppendorf® and the Eppendorf Brand Design are registered trademarks of Eppendorf SE, Germany.
All rights reserved, incl. graphics and pictures. Copyright ©2021 by Eppendorf SE.

ISO
9001
Certified

ISO 13485
Certified

ISO 14001
Certified

CERTIFICATE OF COMPLIANCE

Certificate Number 2019-04-30; C1:2019-07-25-E215059
Report Reference E215059-D1018-1/A0/C1-ULCB
Issue Date 2019-04-30; C1:2019-07-25

Issued to: Eppendorf AG
Applicant Company: Barkhausenweg 1
Hamburg, 22339 Germany

Listed Company: Same as Applicant

This is to certify that representative samples of Laboratory centrifuge
5420

Have been investigated by UL in accordance with the Standard(s) indicated on this Certificate.

Standard(s) for Safety: UL 61010-1, 3rd Edition, May 11, 2012, Revised April 29 2016, CAN/CSA-C22.2 No. 61010-1-12, 3rd Edition, Revision dated April 29 2016, IEC 61010-1:2010 (Third Edition)

Additional Standards: IEC61010-2-020:2016; IEC61010-2-101:2015

Additional Information: See the UL Online Certifications Directory at www.ul.com/database for additional information.

Only those products bearing the UL Certification Mark should be considered as being covered by UL's Certification and Follow-Up Service.

Look for the UL Certification Mark on the product.

This is to certify that representative samples of the product as specified on this certificate were tested according to the current UL requirements.



Bruce Mahrenholz, Assistant Chief Engineer, Global Inspection and Field Services, UL LLC



Helena Y. Wolf, Director, Global Market Access Operations, UL LLC

Any information and documentation involving UL Mark services are provided on behalf of UL LLC (UL) or any authorized licensee of UL. For questions, please contact a local UL Customer Service Representative www.ul.com/contactus





Public Health
England

Public Health England
National Infection Service
Porton Down
Salisbury
Wiltshire
SP4 OJG

Certificate of Containment Testing

Containment Testing of Rotor FA-24x2 in an Eppendorf 5420 Bench Top Centrifuge

Report No. 18/008 B

Report Prepared For: Eppendorf AG, Hamburg, Germany

Issue Date: 20 July 2018

Test Summary

Rotor FA-24x2 was containment tested in an Eppendorf 5420 bench top centrifuge, using Annex AA of IEC 61010-2-020:2016 (3rd Ed.). The sealed rotor was shown to contain a spill.

Report Written By

Name: Ms Helen Hookway

Title: Biosafety Scientist

Report Authorised By

Name: Ms Anna Moy

Title: Biosafety Scientist

Please be aware that the use of the Royal Coat of Arms is highly restricted and cannot be copied. Please do not put the PHE logo on your website or use our name to endorse your products. Any reference to PHE needs to be approved by us before it can be used.

Evaluate Your Manual

Give us your feedback.
www.eppendorf.com/manualfeedback



Eppendorf SE
Barkhausenweg 1
22339 Hamburg
Germany

Your local distributor: www.eppendorf.com/contact
eppendorf@eppendorf.com · www.eppendorf.com