

Register your instrument!  
[www.eppendorf.com/myeppendorf](http://www.eppendorf.com/myeppendorf)



# Centrifuge 5910 Ri

Operating Manual

Copyright © 2021 Eppendorf SE, Germany. All rights reserved, including graphics and images. No part of this publication may be reproduced without the prior permission of the copyright owner.

Corning® is a registered trademark of Corning Inc., USA.

Microtainer® is a registered trademark of Becton Dickinson, USA.

Parasep® is a registered trademark of Apacor Ltd, UK.

Eppendorf® and the Eppendorf Brand Design are registered trademarks of Eppendorf SE, Germany.

FastTemp™ is a protected trademark of Eppendorf SE, Germany.

Registered trademarks and protected trademarks are not marked in all cases with ® or ™ in this manual.

U.S. Design Patents are listed on [www.eppendorf.com/ip](http://www.eppendorf.com/ip)

## Table of contents

<b>1</b>	<b>Operating instructions</b>	<b>9</b>
1.1	Using this manual	9
1.2	Danger symbols and danger levels	9
1.2.1	Danger symbols	9
1.2.2	Danger levels	9
1.3	Symbols used	10
1.4	Abbreviations used	10
<b>2</b>	<b>Safety</b>	<b>11</b>
2.1	Intended use	11
2.2	User profile	11
2.3	Application limits	11
2.4	Warnings for intended use	12
2.4.1	Personal injury or damage to device	12
2.4.2	Incorrect handling of the centrifuge	14
2.4.3	Incorrect handling of the rotors	14
2.4.4	Extreme strain on the centrifugation tubes	16
2.5	Safety instructions on the device and accessories	17
2.6	Obligation to report accidental damage or damage to the device	17
2.6.1	Manufacturer Eppendorf SE	17
2.6.2	Local Eppendorf distributor	17
<b>3</b>	<b>Product description</b>	<b>19</b>
3.1	Product overview	19
3.2	Delivery package	19
3.3	Features	20
3.4	Name plate	21
<b>4</b>	<b>Installation</b>	<b>23</b>
4.1	Selecting the location	23
4.2	Preparing installation	24
4.3	Installing the instrument	25
4.3.1	Connecting the device to the mains/power line	25
4.4	Registering the device	25
4.4.1	VisioNize onboard devices	26
<b>5</b>	<b>Operation</b>	<b>27</b>
5.1	First steps	27
5.1.1	Setting up the device	27
5.2	Switching the device on and off	27
5.2.1	Switching on the device	27
5.2.2	Switching off the device	27
5.3	Opening and closing the centrifuge lid	27
5.4	Replacing the rotor	28
5.4.1	Inserting the rotor	28
5.4.2	Removing the rotor	28
5.4.3	Triggering rotor detection	28

5.5	Loading a fixed-angle rotor. . . . .	29
5.5.1	Closing the rotor lid . . . . .	30
5.5.2	Closing the QuickLock rotor lid. . . . .	30
5.6	Loading a swing-bucket rotor . . . . .	31
5.6.1	Inserting the bucket in the swing-bucket rotor. . . . .	32
5.6.2	Performing an imbalance calibration . . . . .	32
5.6.3	Loading buckets symmetrically. . . . .	33
5.6.4	Closing the bucket with the cap . . . . .	34
5.6.5	Mixed equipping with different buckets. . . . .	35
5.7	Information on aerosol-tight centrifugation . . . . .	35
5.7.1	Aerosol-tight centrifugation in a fixed-angle rotor . . . . .	36
5.8	Operating the user interface . . . . .	36
5.8.1	Home screen . . . . .	37
5.8.2	Logging in and out as a user. . . . .	38
5.8.3	Symbols. . . . .	39
5.9	Menu . . . . .	39
5.9.1	Opening the menu. . . . .	39
5.9.2	Events . . . . .	40
5.9.3	Run Records . . . . .	41
5.9.4	Export . . . . .	43
5.9.5	Locking and cleaning the touchscreen . . . . .	43
<b>6</b>	<b>Centrifugation. . . . .</b>	<b>45</b>
6.1	Centrifugation with time setting . . . . .	45
6.1.1	Setting the centrifugation time . . . . .	45
6.1.2	Setting the temperature . . . . .	46
6.1.3	Setting the rotational speed or g-force . . . . .	47
6.1.4	Setting the acceleration ramp and braking ramp . . . . .	48
6.1.5	Starting centrifugation . . . . .	48
6.1.6	End of centrifugation . . . . .	49
6.2	Performing centrifugation with the Short Spin function . . . . .	50
6.2.1	Making Short Spin settings. . . . .	50
6.2.2	Starting and stopping Short Spin centrifugation . . . . .	51
6.3	Performing a temperature control run with the Fast Temp function . . . . .	51
6.3.1	Making Fast Temp settings . . . . .	51
6.3.2	Performing a temperature control run . . . . .	52
<b>7</b>	<b>User administration . . . . .</b>	<b>53</b>
7.1	The user management concept. . . . .	53
7.1.1	Administrator . . . . .	53
7.1.2	User with standard rights . . . . .	53
7.1.3	User with restricted rights . . . . .	53
7.1.4	User rights without user management . . . . .	53
7.1.5	User rights. . . . .	53
7.2	Setting up user management . . . . .	56
7.2.1	Creating an administrator . . . . .	56
7.2.2	Editing the user management. . . . .	57
7.2.3	Disabling user management . . . . .	58



7.3	Editing user accounts as administrator. . . . .	59
7.3.1	Creating a user account . . . . .	59
7.3.2	Editing user accounts . . . . .	60
7.3.3	Deleting a user account . . . . .	60
7.3.4	Resetting the password/PIN for a user account . . . . .	61
7.4	Managing your own user account. . . . .	62
<b>8</b>	<b>Programming . . . . .</b>	<b>63</b>
8.1	Favorites function . . . . .	63
8.1.1	Accessing the Favorites function . . . . .	63
8.1.2	Creating a favorite for Time and Speed . . . . .	63
8.2	Programs function. . . . .	63
8.2.1	Accessing the Programs function . . . . .	64
8.2.2	Creating a program . . . . .	64
8.2.3	Managing programs . . . . .	65
<b>9</b>	<b>Settings . . . . .</b>	<b>67</b>
9.1	Accessing the Settings . . . . .	67
9.2	About this Centrifuge 5910 Ri. . . . .	67
9.3	System Settings. . . . .	67
9.3.1	Accessing the System Settings . . . . .	67
9.3.2	Accessing the Date and TimeSettings. . . . .	68
9.3.3	Accessing the Network settings . . . . .	69
9.3.4	Activating Manual Setup. . . . .	69
9.4	Device Settings . . . . .	70
9.4.1	Accessing the Device Settings . . . . .	70
9.4.2	Display Settings. . . . .	70
9.4.3	Language. . . . .	70
9.4.4	Short Spin . . . . .	71
9.4.5	Sound Settings . . . . .	71
9.5	Adding service intervals . . . . .	71
9.5.1	Accessing Maintenance and Qualification . . . . .	71
9.5.2	Adding Recurring Tasks . . . . .	72
9.5.3	Rotor Health . . . . .	72
<b>10</b>	<b>Maintenance . . . . .</b>	<b>73</b>
10.1	Service options . . . . .	73
10.2	Service. . . . .	73
10.2.1	Confirming Recurring Tasks . . . . .	74
10.2.2	Displaying Rotor Health . . . . .	74
10.3	Prepare cleaning/disinfection . . . . .	75
10.4	Performing cleaning/disinfection . . . . .	76
10.4.1	Cleaning and disinfecting the device . . . . .	77
10.4.2	Cleaning and disinfecting the rotor. . . . .	78
10.4.3	Changing the seal of the aerosol-tight cap . . . . .	78
10.5	Additional care instructions for refrigerated centrifuges. . . . .	79
10.6	Cleaning glass breakage . . . . .	80
10.7	Resetting the excess current switch . . . . .	80
10.8	Decontamination before shipment . . . . .	80
10.9	Performing a software update. . . . .	81

<b>11</b>	<b>Troubleshooting</b>	<b>83</b>
11.1	General errors	83
11.1.1	Restarting the software	83
11.1.2	Checking the cable connections	83
11.2	Emergency release	84
<b>12</b>	<b>Transport, storage and disposal</b>	<b>85</b>
12.1	Transport	85
12.2	Storage	85
12.3	Disposal	86
<b>13</b>	<b>Technical data</b>	<b>87</b>
13.1	Power supply	87
13.2	Weight/dimensions	87
13.3	Noise level	88
13.4	Ambient conditions	88
13.5	Application parameters	88
13.6	Temperatures	89
13.7	Acceleration and deceleration times	89
13.8	Service life of accessories	92
<b>14</b>	<b>Rotors for the Centrifuge 5910 Ri</b>	<b>95</b>
14.1	Rotor S-4xUniversal	95
14.1.1	Swing-bucket rotor S-4xUniversal with 4 universal buckets	95
14.1.2	Swing-bucket rotor S-4xUniversal with 4 universal buckets and a plate carrier	99
14.2	Rotor S-4x750	101
14.2.1	Swing-bucket rotor S-4x750 with 4 750 mL round buckets	101
14.2.2	Swing-bucket rotor S-4x750 with 4 plate buckets	105
14.3	Rotor S-4x500	107
14.3.1	Swing-bucket rotor S-4x500 with 4 500 mL rectangular buckets	107
14.3.2	Swing-bucket rotor S-4x500 with 4 MTP/Flex buckets	110
14.4	Rotor S-4x400	112
14.5	Rotor FA-6x50	115
14.6	Rotor FA-20x5	118
14.7	Rotor FA-48x2	119
14.8	Rotor FA-30x2	121
14.9	Rotor FA-6x250	122
14.10	Rotor F-48x15	125

<b>15 Ordering Information</b> .....	<b>127</b>
15.1 Rotors and accessories .....	127
15.1.1 Rotor S-4×Universal .....	127
15.1.2 Rotor S-4×750 .....	127
15.1.3 Rotor S-4×500 .....	128
15.1.4 Rotor S-4×400 .....	128
15.1.5 Rotor FA-6×50 .....	129
15.1.6 Rotor FA-20×5 .....	129
15.1.7 Rotor FA-48×2 .....	129
15.1.8 Rotor FA-30×2 .....	130
15.1.9 Rotor F-48×15 .....	130
15.1.10 Rotor FA-6×250 .....	130
15.2 Accessories .....	131
 <b>Certificates</b> .....	 <b>132</b>



## 1 Operating instructions







### 1.1 Using this manual

- ▶ Read this operating manual completely before using the device for the first time. Observe the instructions for use of the accessories where applicable.
- ▶ This operating manual is part of the product. Please keep it in a place that is easily accessible.
- ▶ Enclose this operating manual when transferring the device to third parties.
- ▶ The current version of the operating manual for all available languages can be found on our webpage [www.eppendorf.com/manuals](http://www.eppendorf.com/manuals).

### 1.2 Danger symbols and danger levels

#### 1.2.1 Danger symbols

The safety instructions in this manual have the following danger symbols and danger levels:

	<b>Biohazard</b>		<b>Electric shock</b>
	<b>Hazard point</b>		<b>Material damage</b>
	<b>Explosive substances</b>		<b>Risk of crushing</b>

#### 1.2.2 Danger levels

<b>DANGER</b>	<i>Will</i> lead to severe injuries or death.
<b>WARNING</b>	<i>May</i> lead to severe injuries or death.
<b>CAUTION</b>	May lead to light to moderate injuries.
<b>NOTICE</b>	May lead to material damage.

**Operating instructions**

Centrifuge 5910 Ri  
English (EN)

**1.3 Symbols used**

Depiction	Meaning
1. 2.	Actions in the specified order
▶	Actions without a specified order
•	List
<i>Text</i>	Display or software texts
<b>i</b>	Additional information

**1.4 Abbreviations used****CE**

European Community – A CE indicates that a product has been tested before being placed on the market and complies with the safety, health and/or environmental protection requirements of the European Union.

**MTP**

Microplate

**PCR**

Polymerase Chain Reaction

**rcf**

Relative centrifugal force : *g*-force in  $m/s^2$

rpm

**UV**

Ultraviolet radiation

## 2 Safety

### 2.1 Intended use

The Centrifuge 5910 Ri is a non-automatic centrifuge for separating liquid substance mixtures from the human body and is specifically intended for use as an accessory with an in-vitro diagnostic device in order to facilitate the in-vitro diagnostic device to be used in accordance with its intended use.

Eppendorf centrifuges are only intended for indoor use and for operation by trained and skilled personnel.

### 2.2 User profile

The device and accessories may only be operated by trained and skilled personnel.

Before using the device, read the operating manual and the instructions for use of the accessories carefully and familiarize yourself with the device's mode of operation.

### 2.3 Application limits

---



#### **DANGER! Risk of explosion.**

- ▶ Do not use the device in an explosive atmosphere.
  - ▶ Do not operate the device in areas where work with explosive substances is carried out.
  - ▶ Do not use the device to process any explosive or highly reactive substances.
  - ▶ Do not use the device to process any substances which could generate an explosive atmosphere.
- 

Due to its design and the environmental conditions inside the device, the Centrifuge 5910 Ri is not suitable for use in a potentially explosive atmosphere.

The device may only be used in a safe environment, such as in the open environment of a ventilated laboratory or a fume hood. The use of substances that could contribute to a potentially explosive atmosphere is not permitted. The final decision on the risks associated with the use of such substances is the user's responsibility.

## 2.4 Warnings for intended use

### 2.4.1 Personal injury or damage to device



**WARNING! Electric shock due to damage to the device or the mains/power cord.**

- ▶ Only switch on the device if the device and the mains/power cord are undamaged.
- ▶ Only operate devices which have been installed or repaired properly.
- ▶ In the event of danger, disconnect the device from the mains/power supply voltage. Disconnect the mains/power plug from the device or the earth/grounded socket. Use the isolating device intended for this purpose (e.g., the emergency switch in the laboratory).



**WARNING! Lethal voltages inside the device.**

Touching high-voltage parts can cause an electric shock. Electric shocks can cause heart injury and respiratory paralysis.

- ▶ Ensure that the housing is closed and undamaged.
  - ▶ Do not remove the housing.
  - ▶ Make sure that no liquids enter the device.
- Only authorized service staff may open the device.



**WARNING! Danger due to incorrect voltage supply.**

- ▶ Only connect the device to voltage sources which correspond with the electrical requirements on the name plate.
- ▶ Only use earth/grounded sockets with a protective earth (PE) conductor.
- ▶ Only use mains/power cords that are approved for the technical data specified on the name plate and taking into account national laws and regulations. This also includes testing labels if required by law.



**WARNING! Damage to health due to infectious liquids and pathogenic germs.**

- ▶ When handling infectious liquids and pathogenic germs, observe the national regulations, the biosafety level of your laboratory, and the manufacturers' Safety Data Sheets and application notes.
- ▶ Use aerosol-tight locking systems to centrifuge these substances.
- ▶ When working with pathogenic germs which belong to a higher risk group, more than one aerosol-tight bioseal must be used.
- ▶ Wear your personal protective equipment.
- ▶ For comprehensive regulations about handling germs or biological material of risk group II or higher, please refer to the "Laboratory Biosafety Manual" (source: World Health Organization, Laboratory Biosafety Manual, in the currently valid version).





**WARNING! Risk of injury from rotating rotor.**

If the emergency release of the lid is operated, the rotor may continue to rotate for several minutes.

- ▶ Wait for the rotor to stop before activating the emergency release.
- ▶ To check, look through the monitoring glass in the centrifuge lid.



**WARNING! Risk of injury due to defective gas spring(s).**

A defective gas spring provides insufficient support for the centrifuge lid. There is a risk of crushing fingers or limbs.

- ▶ Make sure that the centrifuge lid can be opened fully and that it will remain in this position.
- ▶ Regularly check all gas springs for their proper function.
- ▶ Have defective gas springs replaced immediately.
- ▶ Have gas springs replaced by a service technician every 2 years.



**WARNING! Risk of injury from chemically or mechanically damaged accessories.**

Even minor scratches and cracks can lead to severe internal material damage.

- ▶ Protect all accessory parts from mechanical damage.
- ▶ Inspect the accessories for damage before each use. Replace any damaged accessories.
- ▶ Do not use any accessories which have exceeded their maximum service life.



**CAUTION! Poor safety due to incorrect accessories and spare parts.**

The use of accessories and spare parts other than those recommended by Eppendorf may impair the safety, functioning and precision of the device. Eppendorf cannot be held liable or accept any liability for damage resulting from the use of accessories and spare parts other than those recommended or from improper use.

- ▶ Only use accessories and original spare parts recommended by Eppendorf.



**NOTICE! Damage to the device due to spilled liquids.**

1. Switch off the device.
2. Disconnect the device from the mains/power supply.
3. Carefully clean the device and the accessories in accordance with the cleaning and disinfection instructions in the operating manual.
4. If a different cleaning and disinfecting method is to be used, contact Eppendorf SE to ensure that the intended method will not damage the device.



**NOTICE! Damage to electronic components due to condensation.**

Condensate may form in the device when it has been transported from a cool environment to a warmer environment.

- ▶ After installing the device, wait for at least 4 h. Only then connect the device to the mains/power line.

**NOTICE! Centrifuge 5910 Ri: Compressor damage after improper transport.**

- ▶ After installation, wait 4 hours before switching on the centrifuge.
- 

## 2.4.2 Incorrect handling of the centrifuge

---

**NOTICE! Damage from knocking against or moving the device during operation.**

If the rotor hits the rotor chamber wall, it will cause considerable damage to the device and rotor.

- ▶ Do not move or knock against the device during operation.
- 

## 2.4.3 Incorrect handling of the rotors

---

**WARNING! Risk of injury from improperly attached rotors and rotor lids.**

- ▶ Only centrifuge with the rotor and rotor lid firmly tightened.
  - ▶ If any unusual noises occur when the centrifuge starts, the rotor or the rotor lid may not be attached properly. Stop the centrifugation immediately.
- 

**CAUTION! Risk of injury due to asymmetric loading of a rotor.**

- ▶ Always load all positions of a swing-bucket rotor with buckets.
  - ▶ Load buckets symmetrically with identical tubes or plates.
  - ▶ Only load adapters with suitable tubes or plates.
  - ▶ Always use tubes or plates of the same type (weight, material/density and volume).
  - ▶ Use a balance to check that loading is symmetrical by balancing the adapters and tubes or plates that are used.
- 

**CAUTION! Risk of injury from overloaded rotor.**

The centrifuge is designed for the centrifugation of material with a maximum density of 1.2 g/mL at maximum speed and filling volume and/or load.

- ▶ Do not exceed the maximum load of the rotor.



**CAUTION! Risk of injury due to chemically damaged rotor lids or caps.**

Transparent rotor lids or caps made from PC, PP or PEI may lose their strength under the impact of organic solvents (e.g. phenol, chloroform).

- ▶ If rotor lids or caps have come into contact with any organic solvents, they should be cleaned immediately.
- ▶ Regularly check the rotor lids and caps for damage and cracks.
- ▶ Replace any rotor lids or caps showing any cracks or milky discolorations immediately.



**NOTICE! Damage to rotors from aggressive chemicals.**

Rotors are high-quality assemblies designed to withstand extreme stresses. This stability can be impaired by aggressive chemicals.

- ▶ Avoid using aggressive chemicals such as strong and weak alkalis, strong acids, solutions with mercury ions, copper ions and other heavy metal ions, halogenated hydrocarbons, concentrated saline solutions and phenol.
- ▶ If it is contaminated by aggressive chemicals, clean the rotor and especially the rotor bores immediately using a neutral cleaning agent.
- ▶ Due to the manufacturing process, color variations may occur on PTFE coated rotors. These color variations do not affect the service life or resistance to chemicals.



**NOTICE! If handled incorrectly, the rotor may fall.**

The swing-bucket rotor may fall if the buckets are used as handles.

- ▶ Remove the buckets before inserting and/or removing a swing-bucket rotor.
- ▶ Always use both hands to carry the rotor cross.



**NOTICE! If handled incorrectly, the rotor may fall.**

- ▶ Always use both hands to pick up the F-48x15 rotor.
- ▶ In order to hold the rotor safely, you may have to remove 3 to 4 sleeves each from the outer rows opposite each other.



**NOTICE! Buckets swinging out in the wrong direction.**

If the wrong adapters are used for 500 mL Corning flasks, the buckets of the swing-bucket rotor may swing out in the wrong direction. If the buckets swing out in the wrong direction, this may lead to sample loss or damage to the centrifuge.

- ▶ Therefore, only use the Eppendorf adapter for 500 mL Corning flasks intended for this purpose.

#### 2.4.4 Extreme strain on the centrifugation tubes

---



**CAUTION! Risk of injury from overloaded tubes.**

- ▶ Note the loading limits specified by the tube manufacturer.
  - ▶ Only use tubes which are approved by the manufacturer for the required *g*-forces (rcf).
- 



**NOTICE! Danger from damaged tubes.**

Damaged tubes must not be used, as this could cause further damage to the device and the accessories and loss of the samples.

- ▶ Visually check all tubes for damage before use.



**NOTICE! Danger due to deformed or brittle tubes. Autoclaving at excessively high temperatures can lead to plastic vessels becoming brittle and deformed.**

This could result in damage to the device and the accessories and sample loss.

- ▶ Observe the temperatures specified by the manufacturer when autoclaving tubes.
- ▶ Do not use any deformed or brittle tubes.



**NOTICE! Danger from open tube lids.**

Open tube lids may break off during centrifugation and damage both the rotor and the centrifuge.

- ▶ Carefully seal all tube lids before centrifuging.



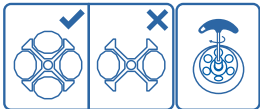



**NOTICE! Damage to plastic tubes due to organic solvents.**

The density of plastic tubes is reduced when organic solvents (e.g. phenol, chloroform) are used, i.e. the tubes may become damaged.

- ▶ Note the manufacturer's information on the chemical resistance of the tubes.
-

## 2.5 Safety instructions on the device and accessories

Symbol	Meaning	Location
	<b>NOTICE</b> ▶ Observe the safety instructions in the operating manual.	Right side of the device
	▶ Observe the operating manual.	Right side of the device
	▶ Always load all 4 positions of the swing-bucket rotor with buckets. ▶ Always tighten the rotor with the enclosed rotor key.	Inside of the centrifuge lid
	Warning of biological risks when handling infectious liquids or pathogenic germs.	Aerosol-tight fixed-angle rotors: rotor lid Aerosol-tight buckets: cap

## 2.6 Obligation to report accidental damage or damage to the device

As the operator of a medical device, you are obliged to report serious accidents or injuries to persons caused by our device to the following authorities:

- The competent local authorities
- Eppendorf SE
- Your local Eppendorf distributor

### 2.6.1 Manufacturer Eppendorf SE

Eppendorf SE

Barkhausenweg 1

22339 Hamburg

GERMANY

eppendorf@eppendorf.com

### 2.6.2 Local Eppendorf distributor

<https://www.eppendorf.com/contact>



### 3 Product description

#### 3.1 Product overview

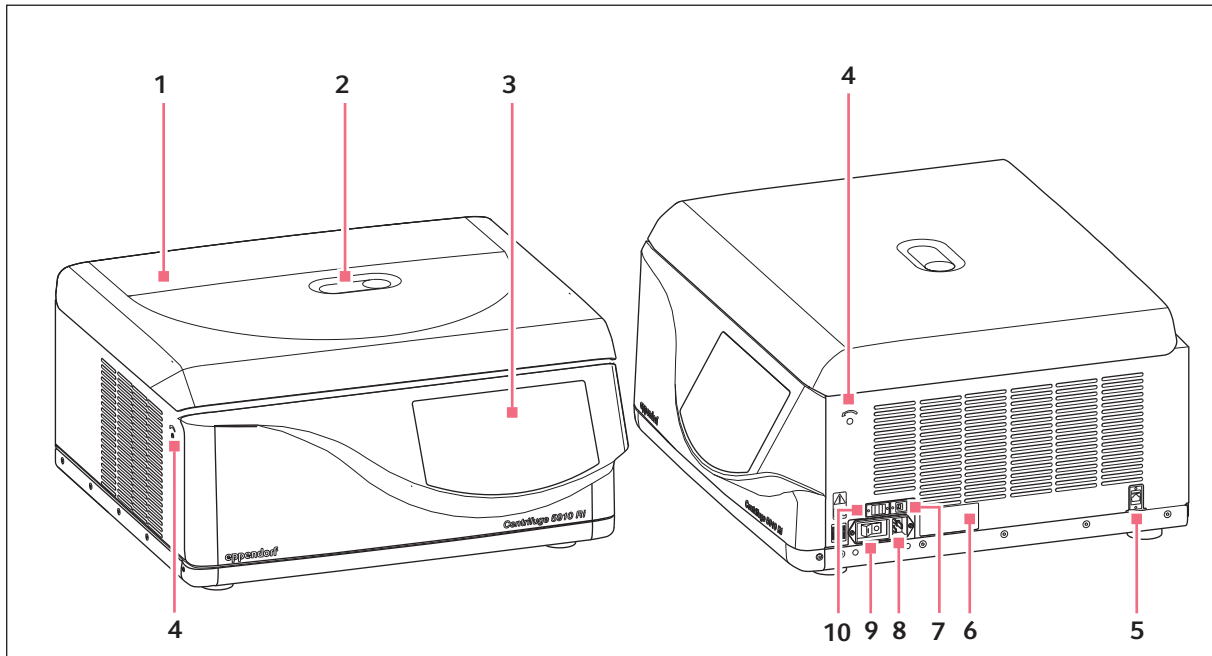


Fig. 3-1: Centrifuge 5910 Ri: Front and side view

- |   |   |
|---|---|
| <p><b>1 Centrifuge lid</b></p> <p><b>2 Monitoring glass</b><br/>Visual monitoring for rotor stop or speed check option using stroboscope.</p> <p><b>3 Touchscreen</b></p> <p><b>4 Emergency release</b></p> <p><b>5 Ethernet port</b></p> | <p><b>6 Name plate</b></p> <p><b>7 USB interface (type B)</b></p> <p><b>8 Mains/power cord socket</b><br/>Connection for the mains/power cord</p> <p><b>9 Mains/power switch</b><br/>Switch for switching the centrifuge on and off</p> <p><b>10 USB interface (type A)</b></p> |
|---|---|

#### 3.2 Delivery package

1	Centrifuge 5910 Ri
1	Rotor key
1	Mains/power cord
1	Directions



- ▶ Check that the delivery is complete.
- ▶ Check all parts for transport damage.
- ▶ To safely transport and store the device, retain the transport box and packing material.

**Product description**

Centrifuge 5910 Ri  
English (EN)

### 3.3 Features

The versatile Centrifuge 5910 Ri has a capacity of up to 4 × 1000 mL and achieves a maximum of 22 132 × *g* or 14000 rpm. You can choose from a range of rotors to centrifuge the following tubes for your various applications:

- Micro test tubes (0.2 mL to 5.0 mL)
- Microtainers
- Spin columns
- Cryogenic tubes
- Conical tubes (15 mL, 50 mL)
- Bottles (175 mL to 1000 mL)
- Microplates
- PCR plates
- Deepwell plates
- Slides (with CombiSlide adapter)
- Blood collection systems

Handling the centrifuge is facilitated by:

- Automatic rotor detection with rotational speed limit
- Automatic rotor imbalance detection
- Touchscreen for operating the centrifuge software

The centrifuge has a favorites function and allows individual programs to be created and managed.

The possibility of setting the radius manually ensures maximum rcf accuracy.

The Centrifuge 5910 Ri also features a temperature control function for centrifuging at temperatures from -11 °C to 40 °C. Use the *Fast Temp* function to start a temperature control run without samples, to adjust the rotor chamber including the rotor, buckets and adapters quickly to the set temperature. Continuous cooling also maintains the temperature in the rotor chamber with the centrifuge lid closed when the centrifuge is not in use.



### 3.4 Name plate

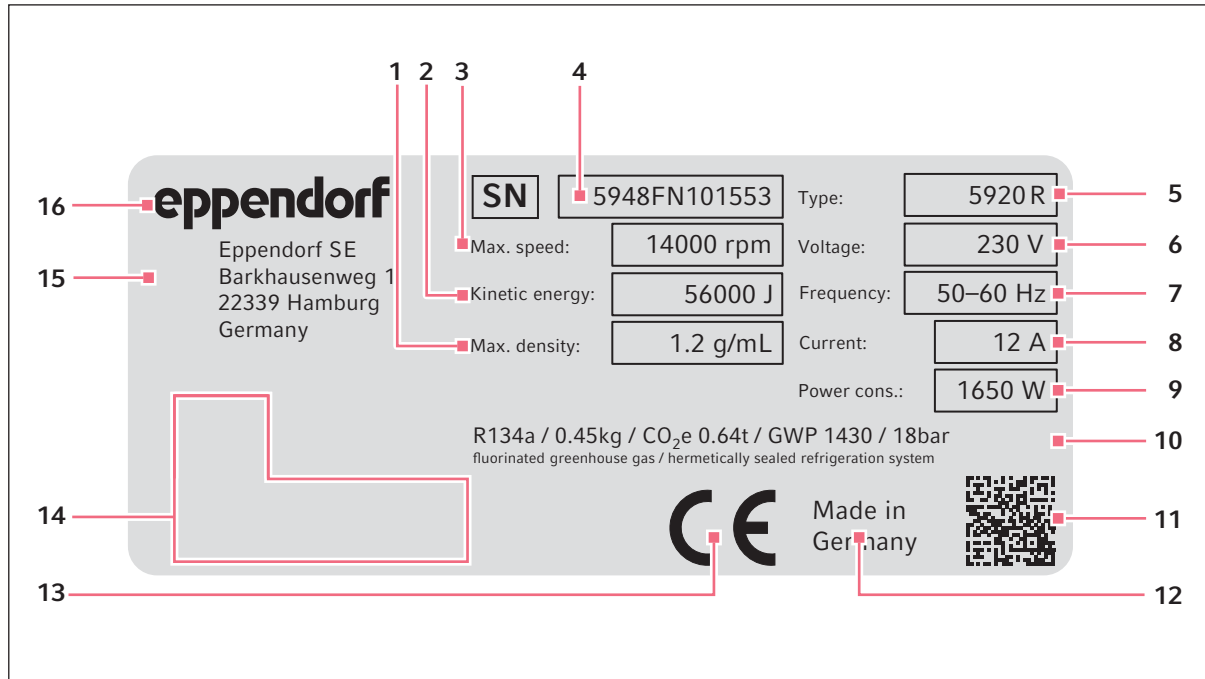









Fig. 3-2: Device identification of Eppendorf SE (example)

- |  |   |
|--|---|
| 1 Maximum density of the material for centrifuging | 9 Maximum rated power   |
| 2 Maximum kinetic energy                           | 10 Information on the refrigerant (refrigerated centrifuges only) |
| 3 Maximum speed                                    | 11 Data matrix code for serial number                             |
| 4 Serial number                                    | 12 Designation of origin  |
| 5 Product name                                     | 13 CE marking   |
| 6 Rated voltage                                    | 14 Certification marks and symbols (device-specific)              |
| 7 Rated frequency                                  | 15 Manufacturer's address   |
| 8 Maximum rated current                            | 16 Manufacturer   |

**Product description**

Centrifuge 5910 Ri  
English (EN)

Tab. 3-1: Certification marks and symbols (device-specific)

Symbol/certification mark	Meaning
	Serial number
	Manufacturer
	Label identifying an in-vitro diagnostic device
	Symbol for waste electrical and electronic equipment (WEEE) according to EU Directive 2012/19/EU, European Community
	UL listing certification mark: Declaration of conformity, USA
	Certification mark for electromagnetic compatibility of the <i>Federal Communications Commission</i> , USA
	Certification mark China – Use of certain hazardous substances in electrical and electronic products ( <i>Requirements for Concentration Limits for Certain Hazardous Substances in Electronic Information Products SJ/T 11363-2006</i> ), People's Republic of China

## 4 Installation

### 4.1 Selecting the location

---



**WARNING! Risk of fire.**

Due to the high current consumption of the centrifuge, an overload may occur if the mains/power line is not protected.

- ▶ Only connect the centrifuge to an electric circuit that has its own protection.
  - ▶ Do not connect any devices to the circuit other than the centrifuge.
  - ▶ Only use mains/power cords that are approved for the technical data specified on the name plate and taking into account national laws and regulations. This also includes testing labels if required by law.
- 



**NOTICE! If a fault occurs, any objects in the immediate proximity of the device will be damaged.**

- ▶ In accordance with the recommendations of EN 61010-2-020, leave a safety clearance of **30 cm** around the device during operation.
- ▶ Please remove all materials and objects from this area.



**NOTICE! Damage from overheating.**

- ▶ Do not install the device near heat sources (e.g., heaters, drying cabinets).
- ▶ Do not expose the device to direct sunlight.
- ▶ Ensure unobstructed air circulation. Maintain a clearance of at least 30 cm around all ventilation gaps.



**NOTICE! Radio interference.**

For devices with Class A noise emission in accordance with DIN EN 61326-1:2013-07 and DIN EN 55011:2018-05, the following applies: This device has been developed and tested in accordance with CISPR 11 Class A. The device may cause radio interference in domestic environments and is not intended for use in residential areas. The device cannot ensure adequate protection of radio reception in residential areas and domestic environments.

- ▶ If necessary, take appropriate measure to eliminate the interferences.
- 



Mains/power connection for centrifuges: Operation of the centrifuge is only permitted in building installations that comply with the applicable national regulations and standards. In particular, it must be ensured that there are no impermissible loads on the supply lines and assemblies that are located upstream of the internal protection of the device. This can be ensured by using additional circuit breakers or other suitable fuse elements in the building installation.



The mains/power switch and the disconnecting device of the mains/power line must be accessible during operation (e.g., residual current circuit breaker).

**Installation**

Centrifuge 5910 Ri  
English (EN)

Select the location of the device according to the following criteria:

- Mains/power connection in accordance with the name plate.
  - Minimum distance to other devices and walls: 30 cm.
  - A resonance-free bench with a horizontal and even work surface which is designed to support the weight of the device.
  - The surrounding area must be well ventilated.
  - The location is protected against direct sunlight.
- ▶ Do not use this device near strong electromagnetic sources (e.g., unshielded high frequency sources) as they could impede proper functioning of the device.

## 4.2 Preparing installation

The weight of the centrifuge is 109 kg.



**CAUTION! Risk of injury when lifting and carrying heavy loads.**

- ▶ Use a lifting aid to install the device.
- 

### Unpacking the centrifuge

1. Loosen the straps.
2. Lift the carton upward and remove it.
3. Remove accessories.
4. Remove the transport securing devices.
5. Remove the plastic sleeve.
6. Lift the centrifuge using a suitable mechanical lifting aid.
7. Place the device on a suitable lab bench.

## 4.3 Installing the instrument

### 4.3.1 Connecting the device to the mains/power line

Prerequisites

The device is on a suitable lab bench.



**WARNING! Danger due to incorrect voltage supply.**

- ▶ Only connect the device to voltage sources which correspond with the electrical requirements on the name plate.
- ▶ Only use earth/grounded sockets with a protective earth (PE) conductor.
- ▶ Only use mains/power cords that are approved for the technical data specified on the name plate and taking into account national laws and regulations. This also includes testing labels if required by law.



**NOTICE! Damage to electronic components due to condensation.**

Condensate may form in the device when it has been transported from a cool environment to a warmer environment.

- ▶ After installing the device, wait for at least 4 h. Only then connect the device to the mains/power line.



**NOTICE! Compressor damage after improper transport.**

- ▶ After installation, wait 4 h before switching on the centrifuge.



**NOTICE! Impairment to the display caused by the protective foil**

The display functionality can be impaired if the protective foil is peeled off when the device is switched on.

- ▶ Remove the protective foil before switching on the device for the first time.
- 

1. Let the device warm up to ambient temperature.
2. Connect the mains/power cord socket to the earth/grounded socket using a mains/power cord.
3. Remove the protective foil from the touchscreen.
4. Switch on the device at the mains/power switch on the right side of the device.

The software starts.

## 4.4 Registering the device

To register a VisioNize onboard device for VisioNize Services, a connection to the local network with Internet access is required. If the device is connected to the Internet, it can be logged into VisioNize via the administrator account access data. Further information on logging the device in to VisioNize can be found in the "VisioNize Lab Suite" software manual at <https://www.eppendorf.com>.

## Installation

Centrifuge 5910 Ri  
English (EN)

### 4.4.1 VisioNize onboard devices

#### Prerequisites:

- Available Ethernet port near the device
  - Standard Ethernet cable
  - Internet access
- Administrator account (Tenant) for VisioNize



Prevention of data loss, loss of samples or misuse of data

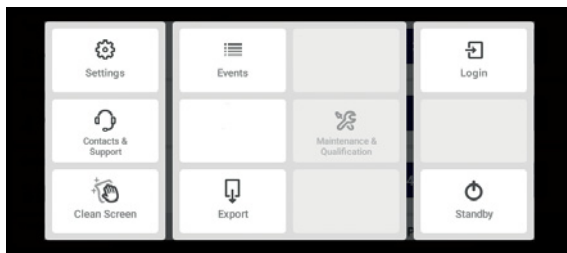
- ▶ Protect the VisioNize onboard device from unauthorized access via the Internet. Contact IT systems administration for questions.



Security risks

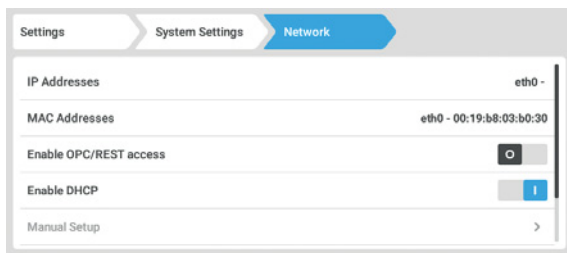
- ▶ Only enable OPC/REST when required. Every communication protocol used to transmit data via the Internet represents a potential security risk.

#### Connecting to the network



1. Connect the Ethernet port of the device to the local network with a standard Ethernet cable via an available Ethernet port.
2. To check the network connection, tap the *Settings* button.
3. Tap *Menu>Settings>System Settings>Network*.

#### DHCP



4. The device can be easily integrated into the network using the DHCP network protocol. Enable the *Enable DHCP* slider.
5. If no DHCP is in use, disable *Enable DHCP*.
6. Tap the *Manual Setup* button.
7. Enter the device parameters for the network.
8. To check the entries: Call *Menu>Settings>System Settings>Network*.  
When the device has been integrated into the network, the IP address of the device will appear next to *IP Addresses*.

If the IP address is not displayed, note the MAC address and contact IT systems administration.

## 5 Operation

### 5.1 First steps

Before the Centrifuge 5910 Ri is used for the first time, the following points must be met:

- The device has been correctly connected.
- The device is free from any damage.
- Unobstructed air circulation at the ventilation gaps is ensured.

#### 5.1.1 Setting up the device

1. Switch on the device at the mains/power switch on the right side of the device.

At this point the software starts in English and guides the user through the Setup.



After Setup has been completed, the user language can be changed under *Menu>Settings>Device Settings>Language*.

## 5.2 Switching the device on and off

### 5.2.1 Switching on the device

1. Switch on the device at the mains/power switch on the right side of the device.

- The software starts.
- The device is ready for operation after 90 seconds.

### 5.2.2 Switching off the device

1. Press the *Open* button.

Residual moisture can evaporate. The pressure on the gas springs is released.

2. Remove the rotor lids from the fixed-angle rotors and the aerosol-tight caps from the buckets.

Aerosol-tight accessories may not be stored when they are closed.

3. Switch off the centrifuge using the mains/power switch.

## 5.3 Opening and closing the centrifuge lid

- ▶ Press the *Open* button to open the locked centrifuge lid.

The electronic lid latch is unlocked and the centrifuge lid is automatically lifted slightly.

- ▶ Manually push the centrifuge lid up completely.

Shock absorbers hold the centrifuge lid in the open position.

- ▶ To close the centrifuge lid, press the centrifuge lid down manually until the electronic lid latch engages and locks the centrifuge lid.

## 5.4 Replacing the rotor



**NOTICE! If handled incorrectly, the rotor may fall.**

The swing-bucket rotor may fall if the buckets are used as handles.

- ▶ Remove the buckets before inserting and/or removing a swing-bucket rotor.
- ▶ Always use both hands to carry the rotor cross.

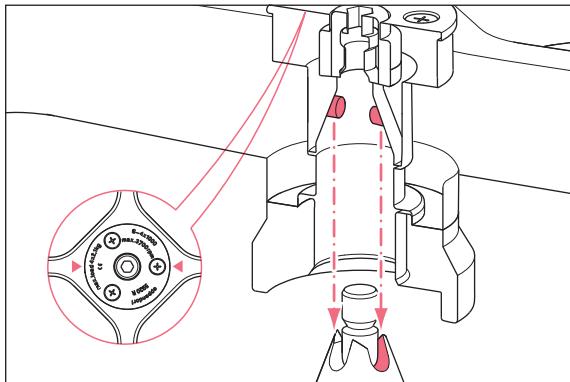


**NOTICE! Material damage due to improper rotor insertion.**

The motor shaft or bearing may become damaged if the rotor falls into the motor shaft guides in an uncontrolled manner when it is inserted.

- ▶ Hold the rotor with both hands.
- ▶ Guide the rotor onto the motor shaft.

### 5.4.1 Inserting the rotor



1. Place the rotor vertically onto the motor shaft from the top.  
The arrows on the rotor show the position of the pegs. The pegs of the rotor must fit into the guides of the motor shaft. If required, lift the rotor and place it onto the motor shaft again.
2. Insert the supplied rotor key into the rotor nut.
3. Turn the rotor key **clockwise** until the rotor nut is firmly tightened.

### 5.4.2 Removing the rotor

1. Turn the rotor nut **counterclockwise** with the supplied rotor key.
2. Lift the rotor out vertically.

### 5.4.3 Triggering rotor detection



**CAUTION! Risk of injury when turning the rotor manually.**

- ▶ When turning a swing-bucket rotor, ensure that your fingers do not get jammed or caught on the buckets.



- ▶ Manually turn the rotor counterclockwise to trigger rotor detection.
- The display briefly shows the message *Rotor detected:* with the designation of the rotor that is located in the device.
- After the message on the display goes out, the rotor designation appears in the status bar.



After a rotor change, the automatic radius is adjusted and the rcf value changes.

## 5.5 Loading a fixed-angle rotor



**CAUTION! Risk of injury due to asymmetric loading of a rotor.**

- ▶ Load rotors symmetrically with identical tubes.
- ▶ Only load adapters with suitable tubes.
- ▶ Always use the same type of tubes (weight, material/density and volume).
- ▶ Use a balance to check that the load is symmetrical by balancing the adapters and tubes that are used.

1. Check the maximum payload (adapter, tube and contents) for each rotor bore.
2. Load rotors and adapters only with the tubes intended for them.
3. To ensure symmetrical loading, insert sets of two tubes in opposite bores. Tubes located opposite each other must be of the same type and contain the same filling quantity.

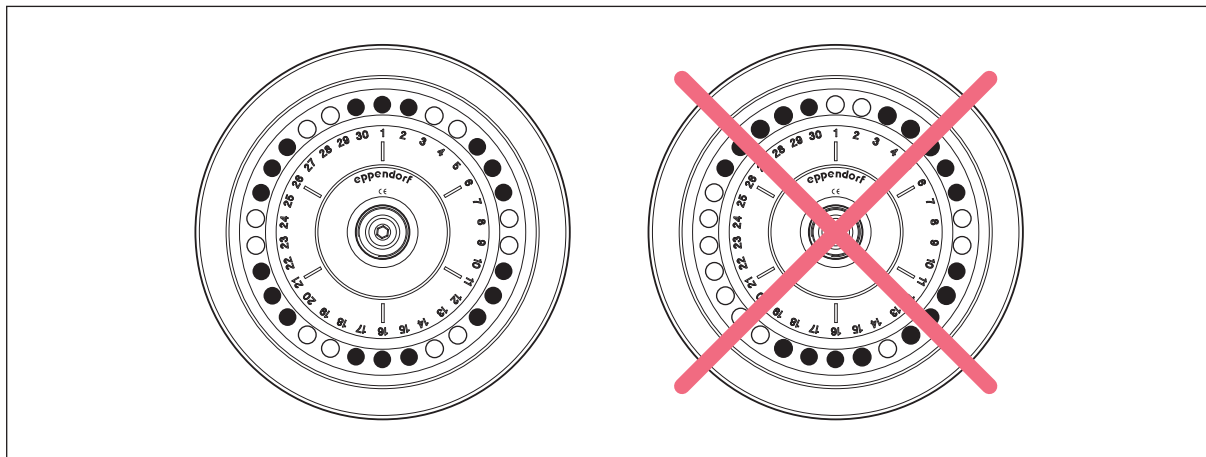


Fig. 5-1: Symmetrical loading of a fixed-angle rotor

To minimize weight differences between filled sample tubes, we recommend balancing with a balance. This will reduce wear on the drive and reduce operating noise.

### 5.5.1 Closing the rotor lid

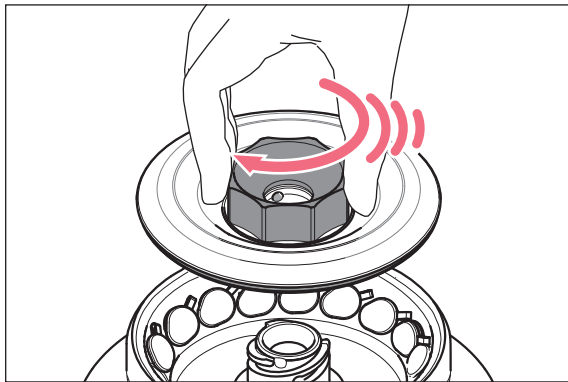


#### Use matching rotor lids

- Fixed-angle rotors may only be operated with the appropriate rotor lid in each case. The rotor name on the rotor must correspond to the rotor name on the rotor lid.

1. Place the rotor lid vertically on the rotor.
2. Turn the rotor lid screw clockwise to seal the rotor.

### 5.5.2 Closing the QuickLock rotor lid



1. Check the correct positioning of the external sealing ring in the groove.
2. Place the rotor lid on the rotor in a vertical motion.
3. To lock the rotor, turn the rotor lid screw clockwise as far as it will go, and after an audible "click" is heard.



The rotor is only properly locked after the audible "click"!

## 5.6 Loading a swing-bucket rotor



### CAUTION! Risk of injury due to asymmetric loading of a rotor.

- ▶ Always load all positions of a swing-bucket rotor with buckets.
- ▶ Load buckets symmetrically with identical tubes or plates.
- ▶ Only load adapters with suitable tubes or plates.
- ▶ Always use tubes or plates of the same type (weight, material/density and volume).
- ▶ Use a balance to check that loading is symmetrical by balancing the adapters and tubes or plates that are used.



### NOTICE! Material damage due to incorrect equipping of the swing-bucket rotor.

Incomplete equipping of the swing-bucket rotor or an uneven load will reduce the life span of the rotor and the corresponding buckets considerably.

- ▶ Always load all positions of a swing-bucket rotor with buckets.
- ▶ Load opposite buckets with the same weight (adapter, tubes, or plates and content).

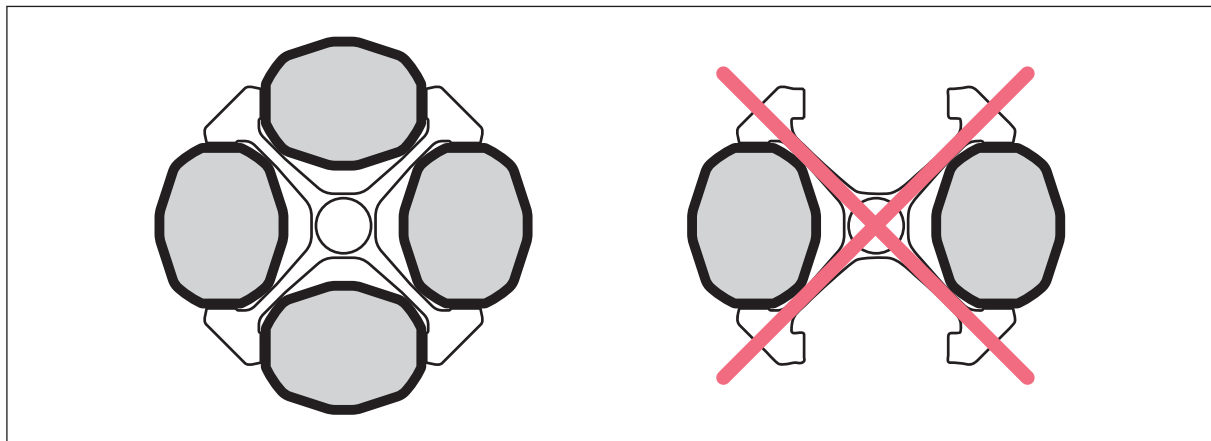
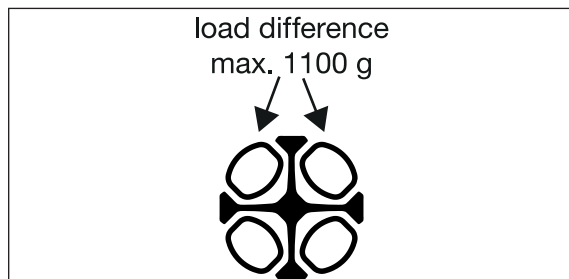


Fig. 5-2: Swing-bucket rotors: Loading all positions with buckets



- ▶ Load adjoining buckets with a maximum of 1100 g difference in weight.

### 5.6.1 Inserting the bucket in the swing-bucket rotor

#### Prerequisites

- The combination of rotor, bucket and adapter has been approved by Eppendorf.
- Buckets that are located opposite each other belong to the same weight class. The weight class is engraved in the sides of the groove: e.g., 68.
- Matching and tested tubes and plates.



The swing-bucket rotor runs more smoothly if all buckets are loaded symmetrically and with the same weight.

- ▶ To reduce noise and vibrations, load the buckets of the swing-bucket rotor with the same weight.

1. Check that the bucket grooves are clean. Use pivot grease to lightly lubricate the grooves.
2. Hang the buckets into the rotor.  
All rotor positions must be equipped with buckets.
3. Check to see if all buckets are completely hung and can freely swing out.
4. Check the maximum load per bucket (adapter, vessel or plate and contents) and the loading height.
5. Load the buckets symmetrically.



- ▶ When using a vessel type or plate type for the first time, carry out a brief test run at low speed (e.g., 1000 rpm).

### 5.6.2 Performing an imbalance calibration

Carry out a manual imbalance calibration when you use a tube or plate for the first time. Always carry out a manual imbalance calibration when you use tubes with a length of > 100 mm.

- ▶ Inserting plates and/or tubes.
- ▶ Swing the buckets manually up to 90°.
  - Bucket swings freely.
  - The tubes do not touch the rotor cross.

### 5.6.3 Loading buckets symmetrically

#### 5.6.3.1 Equipping buckets with vessels

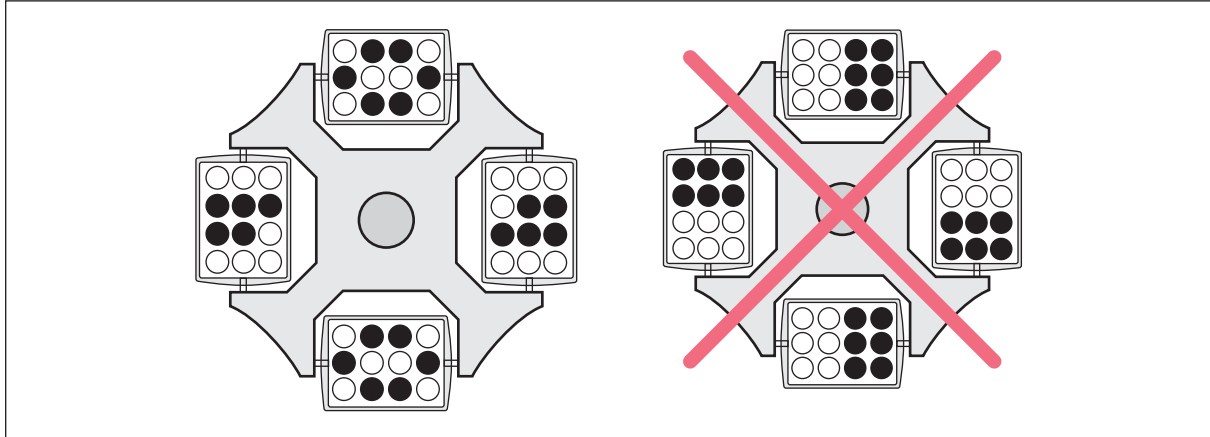


Fig. 5-3: Swing-bucket rotors: Incomplete, but symmetric loading of the buckets.

The loading shown on the right-hand side is incorrect as it places an uneven load on the pegs of the rotor.

- ▶ To reduce vibrations and noise, load all buckets of the swing-buckets rotor equally.

#### 5.6.3.2 Loading plates symmetrically



**NOTICE! Filling the plates too high can cause overflowing.**

During the run the meniscuses in the tubes along the edges of the plates are at an angle. This is due to the centrifugal forces and cannot be avoided.

- ▶ Fill the plate wells to a maximum of 2/3 of the maximum filling volume.

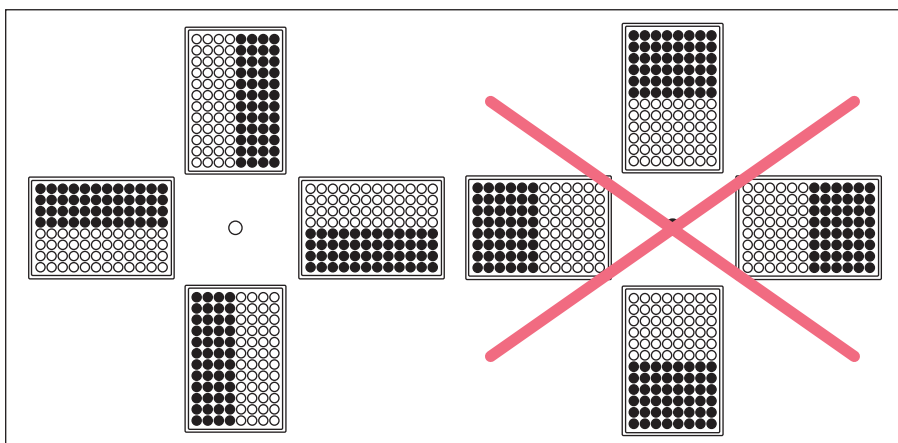


Fig. 5-4: Swing-bucket rotors: Symmetrical loading of plates

- ▶ In order to avoid imbalances, always load the plates symmetrically.

The plate loading shown on the right-hand side is incorrect as the plate buckets will not swing properly if loaded in this way.

### 5.6.3.3 Rotor S-4x750: Equipping the adapter with vessels > 119 mm

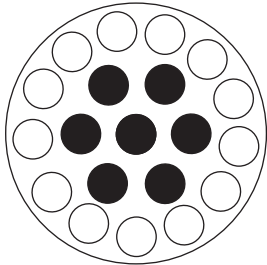


**NOTICE! Broken glass due to incorrect equipping.**

If the tubes in a bucket are too long, the swinging tubes will touch the rotor cross and may get damaged or destroyed.

- ▶ Equip buckets of swing-bucket rotors in such a way that they can swing out freely.
- ▶ If necessary, only equip the inner bores.
- ▶ If using tubes longer than 100 mm: always perform a manual swing-out test.

If the adapter 16 × 75 mm – 100 mm (order number 5825 736.001) is equipped with vessels with a length of > 119 mm, e.g., BD 8 mL Vacutainer, this will result in danger of glass breakage.



- ▶ Only equip the inner bores.

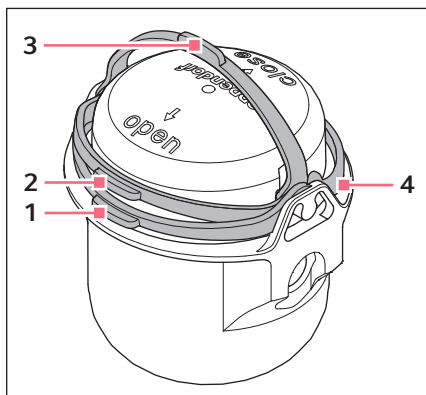
### 5.6.4 Closing the bucket with the cap



**NOTICE! Damage to the cap hook.**

If the cap is not fitted correctly on the bucket, the sealing clamp may break during closing.

- ▶ Before you fold the sealing clamp, check that the cap is positioned correctly.



1. Fold the sealing clamp of the cap to the Open position (1).
2. Place the cap on the bucket and push the cap down in such a way that the clamp is lifted slightly (2).
3. To transport the bucket, fold the clamp to the carrying position (3).
4. To seal the bucket so that it is aerosol-tight, fold the sealing clamp beyond the latch into the Close position.  
The clamp has only been folded correctly if there is an audible *click* (4).

### 5.6.5 Mixed equipping with different buckets

Mixed equipping of swing-bucket rotors with different buckets is possible if these are intended for the rotor. Buckets that are located opposite each other must be of the same type.

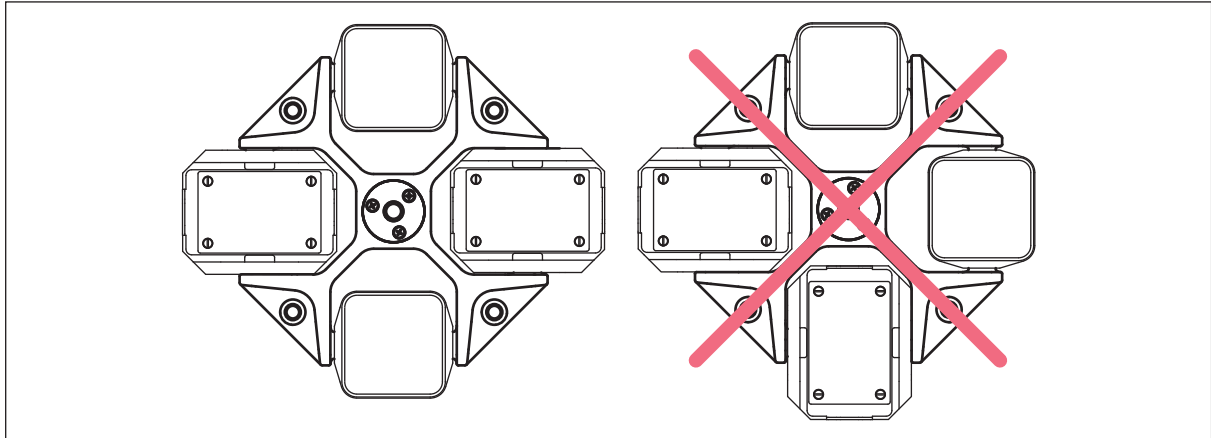


Fig. 5-5: Mixed equipping of a swing-bucket rotor

## 5.7 Information on aerosol-tight centrifugation



**WARNING! Damage to health due to limited aerosol tightness if an incorrect rotor/rotor lid combination is used.**

Aerosol-tight centrifugation is only guaranteed if the rotors and rotor lids intended for this purpose are used. The designation of aerosol-tight fixed-angle rotors always starts with **FA**. The aerosol-tight rotors and rotor lids of this centrifuge are also marked with a red ring on the rotor and a red rotor lid screw.

- ▶ Always use rotors and rotor lids marked as aerosol-tight together for aerosol-tight centrifugation. The details specifying in which centrifuge the aerosol-tight rotors and rotor lids may be used can be found on the rotor and on the top of the rotor lid.
- ▶ Only use aerosol-tight rotor lids in combination with the rotors indicated on the rotor lid.
- ▶ Only use aerosol-tight buckets with the corresponding caps.



**WARNING! Damage to health due to limited aerosol tightness if used incorrectly.**

Mechanical stresses and contamination by chemicals or other aggressive solvents may impair the aerosol tightness of the rotors and rotor lids. Autoclaving at excessively high temperatures can lead to plastic tubes, adapters and rotor lids becoming brittle and deformed.

- ▶ Check the integrity of the seals of the aerosol-tight rotor lids or caps before each use.
- ▶ Only use aerosol-tight rotor lids or caps if the seals are undamaged and clean.
- ▶ Do not exceed temperatures of 121 °C or a time of more than 20 min. when autoclaving.
- ▶ After each proper autoclaving process (121 °C, 20 min.), coat the threads of the rotor lid screw with a thin layer of pivot grease (order no. Int. 5810 350.050, North America 022634330).
- ▶ On aerosol-tight rotor lids with exchangeable seals (e.g. QuickLock rotor lids) the seal only needs to be replaced after 50 autoclaving cycles.
- ▶ Replace aerosol-tight rotor caps after 50 autoclaving cycles.
- ▶ **Never** close aerosol-tight rotors or buckets for storage.



The aerosol tightness of rotors, rotor lids, buckets and caps has been tested and certified according to Annex AA of IEC 61010-2-020.

### 5.7.1 Aerosol-tight centrifugation in a fixed-angle rotor

To ensure aerosol tightness, the following applies:

- Replace aerosol-tight rotor lids without exchangeable seal and cap after 50 autoclaving cycles.
- Replace the seal of aerosol-tight rotor lids with exchangeable seal (e.g., QuickLock rotor lids) after 50 autoclaving cycles.
- Lightly grease the replaced seal with pivot grease after it is inserted.

## 5.8 Operating the user interface



The touchscreen is designed to be operated with your fingers only without the need for tools. Laboratory gloves made of nitrile or latex can be worn. Alternatively, a touch pen for capacitive touchscreens can be used, e.g., if thicker gloves have to be worn in the laboratory.



If liquid comes into contact with the touchscreen, the functions displayed on the touchscreen may be triggered.

- ▶ Do not drop any liquids onto the touchscreen.
- ▶ Do not spill any liquids onto the touchscreen.



### 5.8.1 Home screen

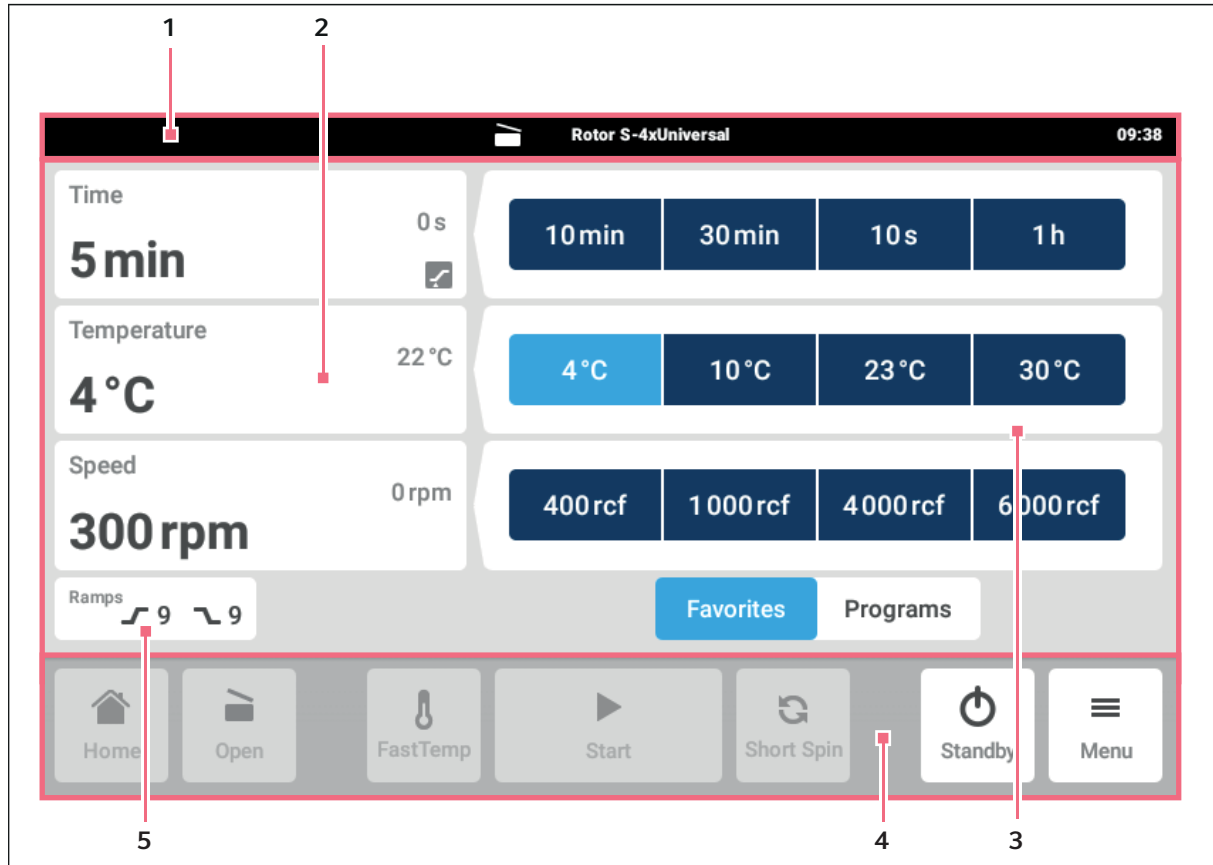


Fig. 5-6: Home screen

- |  |   |
|--|---|
| <p><b>1 Status bar</b><br/>Rotor name<br/>Time</p> <p><b>2 Current information on the device status.</b></p> <p><b>3 Display of saved favorites or available programs.</b></p> | <p><b>4 Toolbar</b><br/>Buttons for navigation and operation of the device</p> <p><b>5 Device-specific function</b></p> |
|--|---|

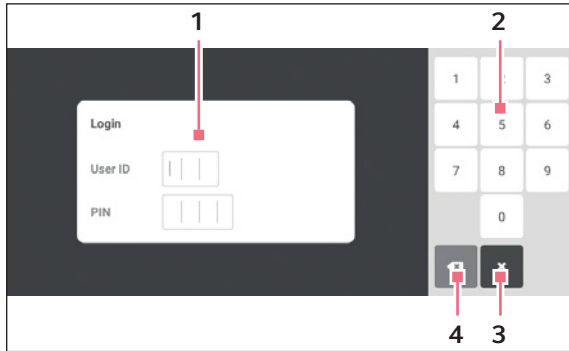
The toolbar (4) contains the buttons for navigating within the software. The toolbar is always visible.

- *Home*: Jump to the home screen.
- *Open/Close*: Open or close the centrifuge lid.
- *Fast Temp*: Start temperature control run without sample.
- *Start/Stop*: Start or stop centrifugation.
- *Short Spin*: Short run centrifugation
- *Standby/Login*: Display of standby mode or login if user management has been set up.
- *Menu*: The menu items for the device are displayed.

## 5.8.2 Logging in and out as a user

### Prerequisites

- User management has been set up.



**1 Edit box**

**2 Number pad**

**3 Cancel login**

**4 Delete input in steps**

### Logging in as a user

1. Tap the *Login* button on the home screen.
2. Enter your user ID or user name.
3. Enter your PIN or password.

If the correct PIN or password was entered, the user is automatically logged in.

### Logging out as a user

#### Prerequisites










- User management has been set up.

1. Tap the *Logout* button on the home screen.



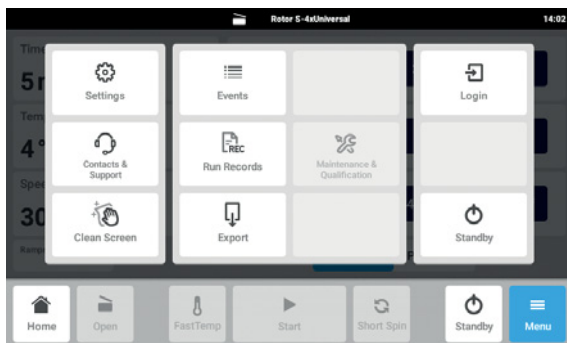
Alternatively, a user can also log out in the *Menu* with the *Logout* button.

### 5.8.3 Symbols

Symbol	Description
	Status: Function active
	Status: Function inactive
	Event Log
	Filter
	Data export
	Options menu
	Notice, value range below minimum threshold. Tap to correct the value range.
	Notice, value range above maximum threshold. Tap to correct the value range.
	Back

## 5.9 Menu

### 5.9.1 Opening the menu



1. Tap the *Menu* button.  
The menu items that are available for the device are displayed.
2. Select the menu item.

## 5.9.2 Events

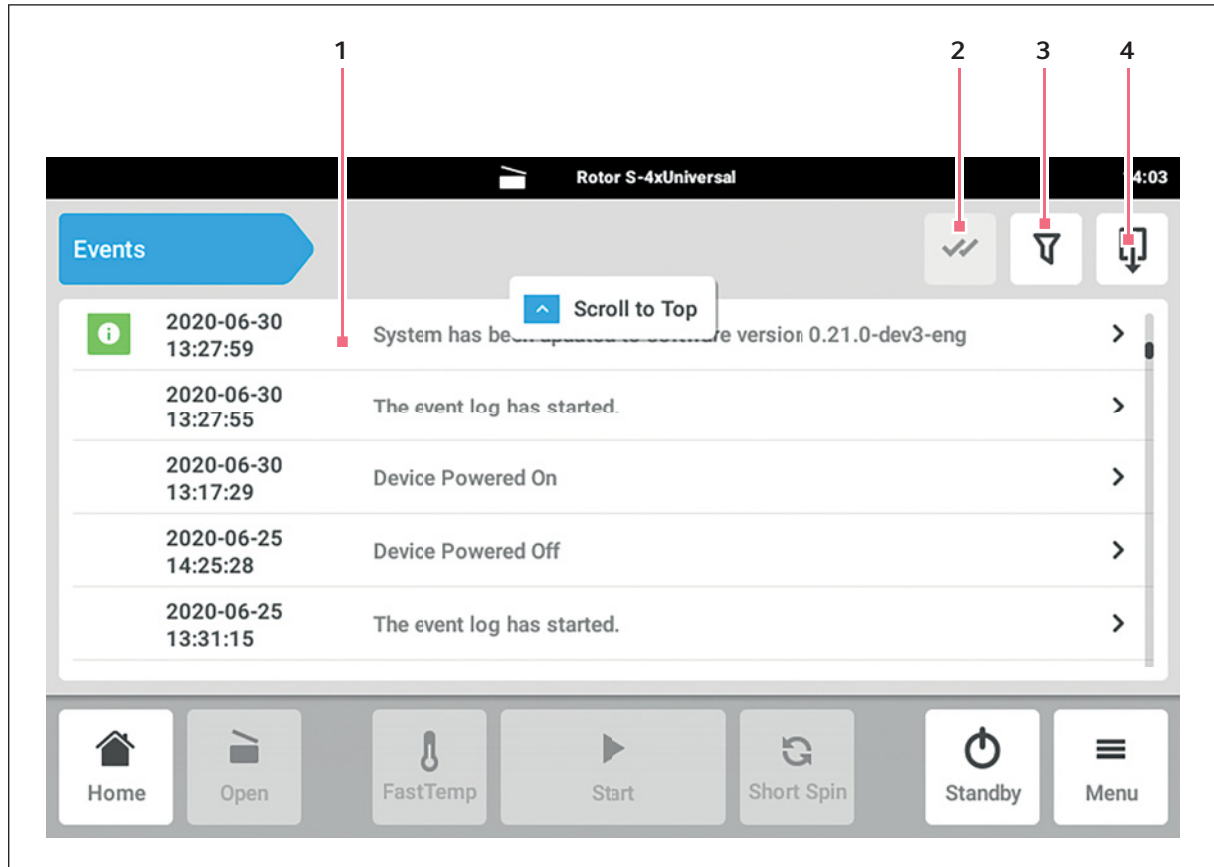


Fig. 5-7: *Events* window

- 1 List of all notifications and messages**
- 2 Confirm open notifications.**
- 3 Filter options**  
The button is highlighted in blue when messages are filtered.
- 4 Export list of messages to a USB storage medium.**

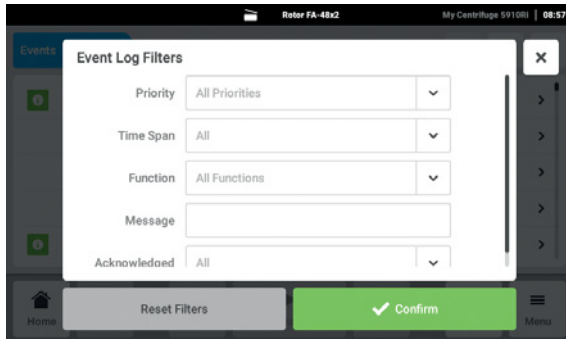


100000 notifications and messages are saved. If there are more than 100000 entries, the oldest entries are overwritten.

### Accessing the Events

1. Tap the *Menu* button.
2. Tap the *Events* button.

## Filtering the Event list



3. Tap the button for the filter options.  
The window with the filter settings opens.

- *Filter by priority*
- *Filter by time span*
- *Filter by function*
- *Filter by message*
- *Filter by acknowledgment status*

If a filter is enabled, a checkmark appears next to the filter.

Tap the *Reset Filters* button to disable all filters.

4. Close the selection window.  
The filtered notifications and messages are displayed.

## Accessing more information

1. Select a notification or message from the Event list.  
The window with detailed information appears.
2. Use the arrow keys to navigate between the notifications and messages.

## Exporting the Event list

1. Connect a USB stick and tap the *Export* button.  
The event list is saved as an Excel table. If the export was successful, the *Export successful* window appears.
2. Confirm the message to complete the process.

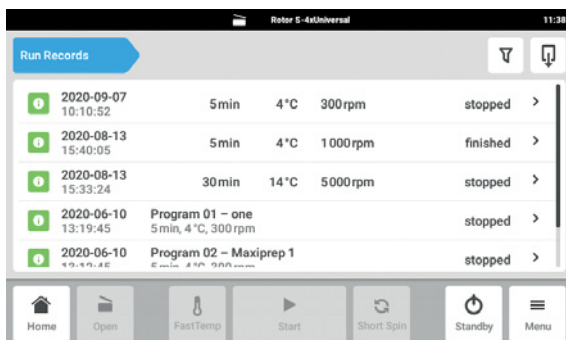
## 5.9.3 Run Records



All centrifugation runs are documented and stored. If there are more than 1000 entries, the oldest entries are overwritten.

### Accessing the Run Records

1. Tap the *Menu* button.
2. Tap the *Run Records* button.



The list of centrifugation runs that have been completed is displayed.

## Operation

Centrifuge 5910 Ri  
English (EN)

### Filtering entries

3. Tap the button for the filter options.

The *Set Filters* window with the following filter options opens:

- *Result*: filter by results by *Completed*, *Completed with warnings* or *Failed*
- *From date*: filter from a date
- *Until date*: filter up to a date
- *Program number*: filter by program number
- *Program name*: filter by program name
- *User*: filter by user if user management has been set

In this window, entries are confirmed with the *Confirm* button or reset with the *Reset Filters* button.

4. Assign values to the required filter options and tap on *Confirm*.

The filtered entries are displayed.

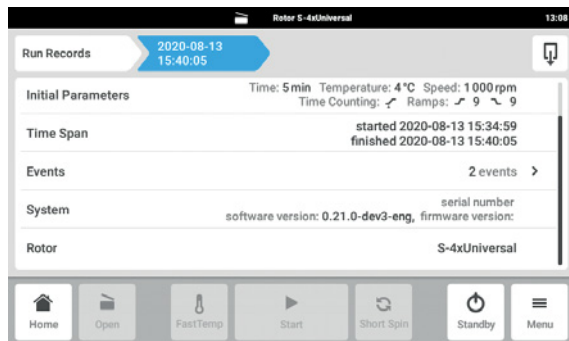
### Exporting entries

5. Connect a USB stick and tap the *Export* button.

The entries are saved in a PDF document. If the export was successful, the *Export successful* window appears.

### Displaying information on a centrifugation run

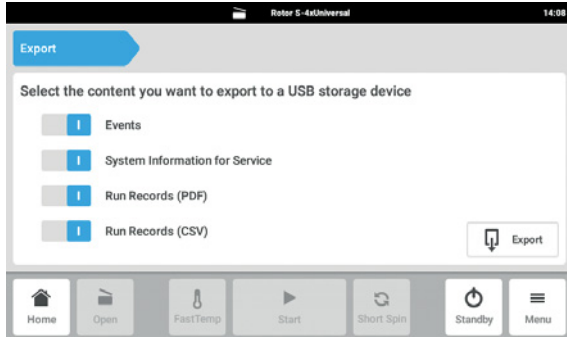
6. Tap the desired list entry.



Information on the selected centrifugation run is displayed and can also be exported.

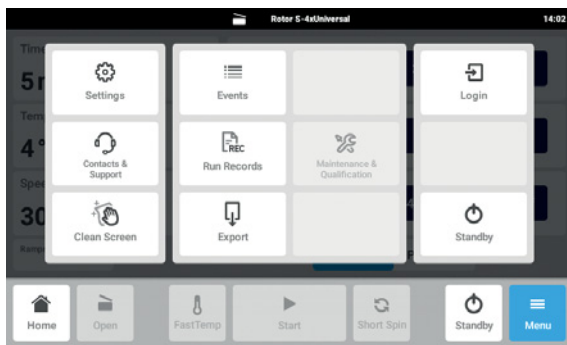
- *Result*: The result *Completed*, *Completed with warnings* or *Failed* is displayed
- *Initial Parameters*: The set time, temperature, speed, acceleration and braking ramps are displayed
- *Time Span*: The start time and end time is displayed
- *Events*: Display events during the centrifugation run
- *System*: System information is displayed
- *Rotor*: The rotor designation is displayed

## 5.9.4 Export



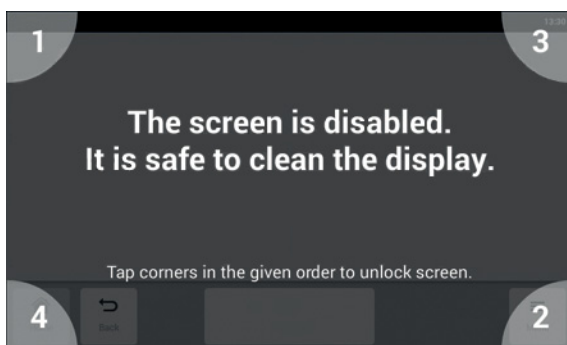
1. Tap the *Menu* button.
2. Tap the *Export* button.  
A selection list for the export appears.
3. Connect a USB stick.
4. Select the data for the export.
5. Tap the *Export* button to export the selected data.
  - The data is saved. If the export was successful, the *Export successful* window appears.
  - The *Run Records (CSV)* data is exported in UTF-8 format.
6. Confirm the message to complete the process.

## 5.9.5 Locking and cleaning the touchscreen



1. Tap the *Menu*>*Clean screen* button.  
The touchscreen is locked for normal usage and can be cleaned.

### Unlocking the locked touchscreen



2. Tap the corners in the numbered sequence.  
The touchscreen is unlocked for operation and the previous screen is displayed.





## 6 Centrifugation

### 6.1 Centrifugation with time setting

#### Prerequisites

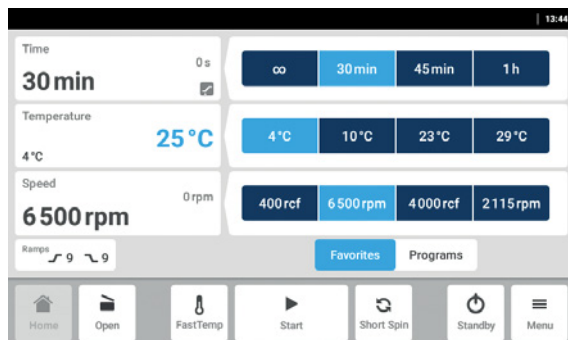
- The centrifuge is switched on.
- The rotor has been inserted and attached correctly.
- The rotor has been loaded correctly.
- The rotor lid has been mounted correctly.
- The buckets can swing out freely.
- The centrifuge lid is closed.



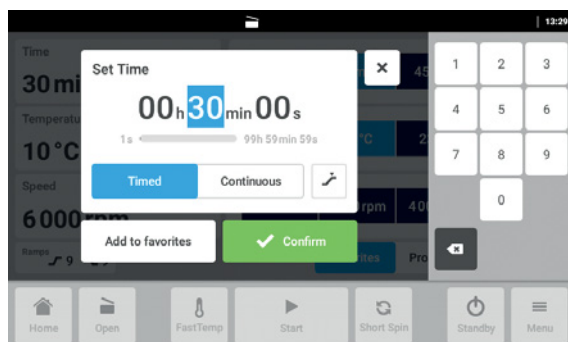
**WARNING! Risk of injury from improperly attached rotors and rotor lids.**

- ▶ Only centrifuge with the rotor and rotor lid firmly tightened.
- ▶ If any unusual noises occur when the centrifuge starts, the rotor or the rotor lid may not be attached properly. Stop the centrifugation immediately.

#### 6.1.1 Setting the centrifugation time



1. Select the *Time* area on the home screen. The *Set Time* input window will open.

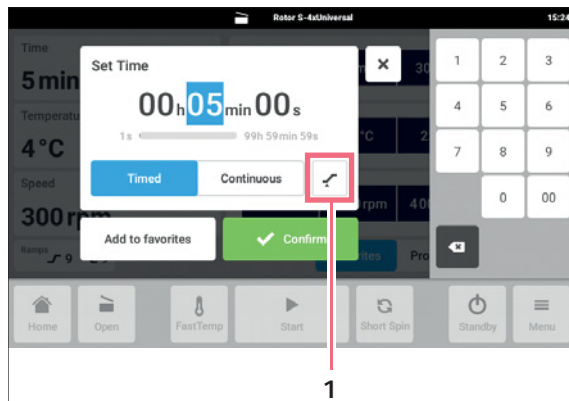


2. Set the centrifugation time.
  - Value range: 1 s – 99 h 59 min 59 s
  - *Timed*: Set the centrifugation time.
  - *Continuous*: Continuous run

## Centrifugation

### Centrifuge 5910 Ri

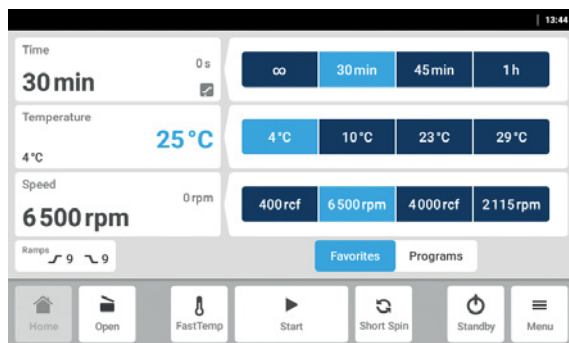
#### English (EN)



- To set the start time for the centrifugation time, press button **1**.
  - Immediately*: Time counting starts immediately.
  - Selected Speed Reached*: Time counting starts when 95% of the specified speed has been reached.
- Confirm the entry with *Confirm*.  
The set value for the centrifugation time is saved.  
The input window closes.

### 6.1.2 Setting the temperature

The centrifuge cools or keeps the set temperature if the centrifuge remains switched on and the lid closed.

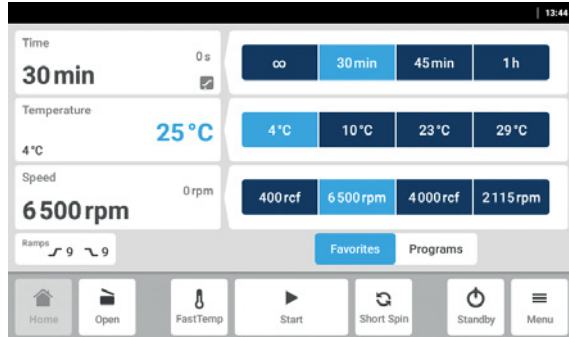


- Select the *Temperature* area on the home screen.  
The *Set Temperature* input window will open.

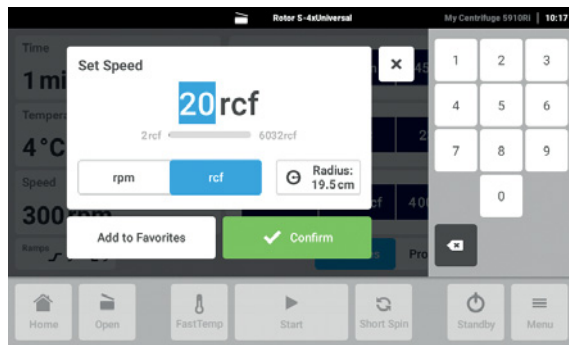


- Set the temperature.  
Value range: -11 °C – 40 °C
- Confirm the entry with *Confirm*.  
The set value for the temperature is saved. The input window closes.

### 6.1.3 Setting the rotational speed or *g-force*



1. Select the *Speed* area on the home screen. The *Set Speed* input window will open.



2. Select the rotational speed or *g-force* display mode.

- *rpm*: Setting the rotational speed
- *rcf*: Setting the *g-force*
- *Radius*: Setting the radius

Values that have already been entered will be converted automatically when you switch between rotational speed and *g-force*. The radius can only be set if *rcf* mode has been selected. If you switch to *rpm* mode after entering the radius, the previously entered radius is not applied.



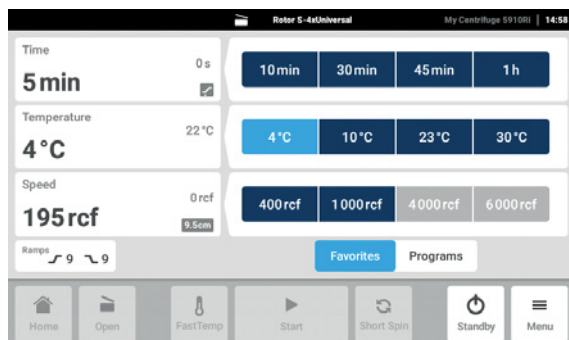
The value range depends on the rotor used.

If the value range falls below or exceeds the relevant thresholds, further navigation is only possible using the Back button under the number pad and the symbol for lower threshold violation or upper threshold violation.

3. Set the rotational speed.

4. Confirm the entry with *Confirm*.

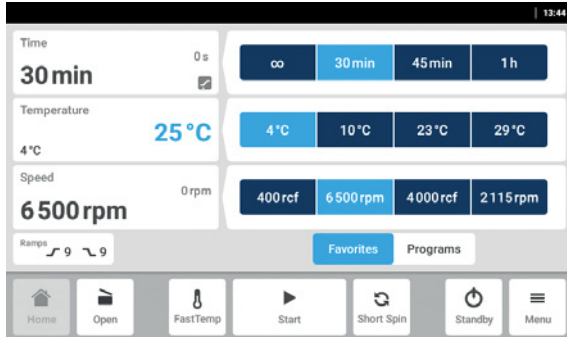
The set value for the rotational speed or *g-force* is saved. The input window closes.



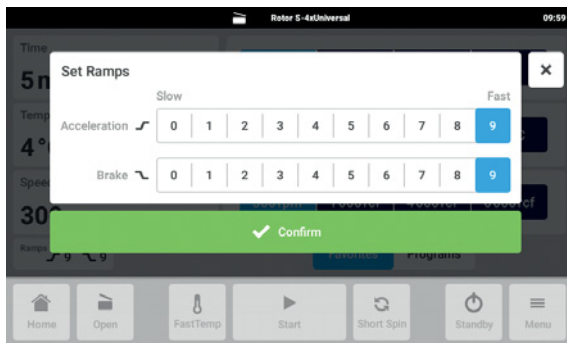
#### Selected *rpm* mode in the *Speed* area

- The set radius is displayed at the bottom right.
- The set radius is only displayed if it deviates from the maximum radius.

### 6.1.4 Setting the acceleration ramp and braking ramp



1. Tap the *Ramps* button on the home screen. The *Set Ramps* input window will open.

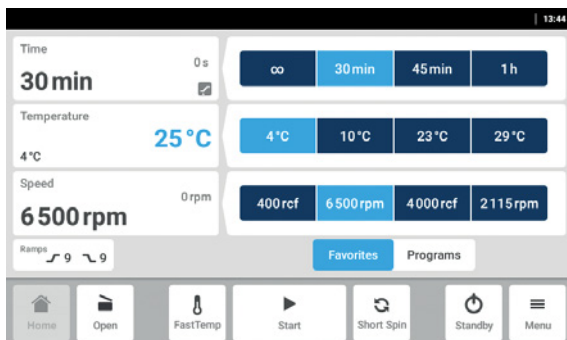


2. Select the stage for the acceleration ramp (*Acceleration*). The selection is shown on a blue background.
3. Select the stage for the braking ramp (*Brake*). The selection is shown on a blue background.
4. Confirm the entry with *Confirm*.

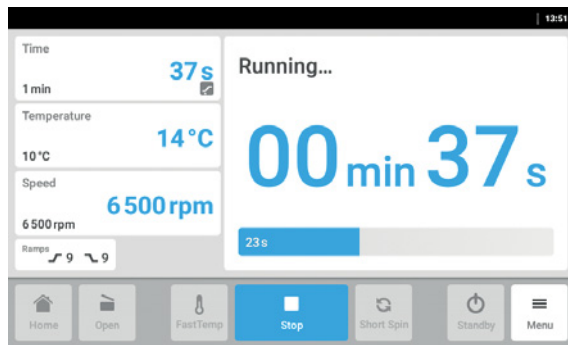
### 6.1.5 Starting centrifugation

#### Prerequisites

- The centrifuge lid is closed.



1. Press *Start* to start the centrifugation run.



During centrifugation, the current values are shown in blue:

- Remaining run time
- Current temperature in the rotor chamber
- Current rotational speed or *g-force*

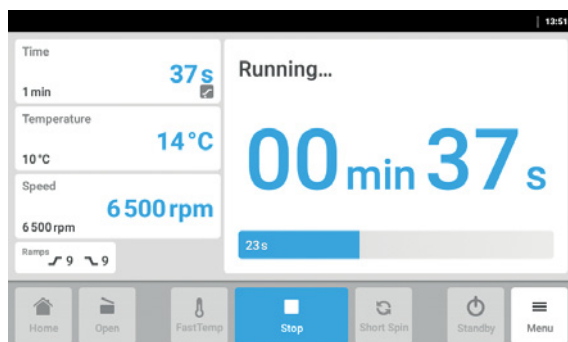
The progress bar is shown as a gray bar at the start and filled in blue as time passes.

All set values are displayed in black.

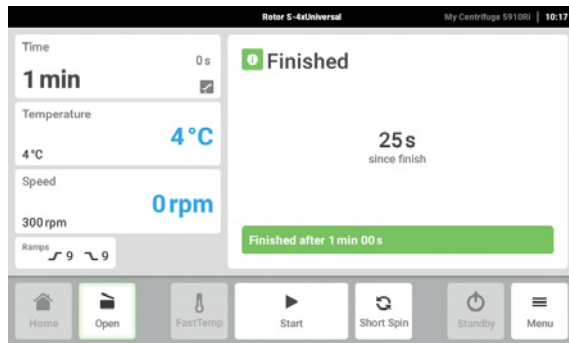
The following values can be changed during the run:

- Centrifugation time
- Temperature
- Speed
- Switching the display between rpm (rotational speed) and rcf (*g-force*).
- Radius
- Acceleration ramp/braking ramp

### 6.1.6 End of centrifugation



1. Press *Stop* to end centrifugation before the set time.  
The centrifuge stops automatically when the set time has elapsed.  
The centrifuge lid remains sealed.



2. Press the *Open* button to open the closed centrifuge lid.

## 6.2 Performing centrifugation with the Short Spin function

### Prerequisites

- The centrifuge is switched on.
- The rotor has been inserted and attached correctly.
- The buckets and adapters have been inserted correctly.
- The rotor has been loaded correctly.
- The rotor lid has been mounted correctly.
- The buckets can swing out freely.
- The centrifuge lid is closed.



**WARNING! Risk of injury from improperly attached rotors and rotor lids.**

- ▶ Only centrifuge with the rotor and rotor lid firmly tightened.
- ▶ If any unusual noises occur when the centrifuge starts, the rotor or the rotor lid may not be attached properly. Stop the centrifugation immediately.

### 6.2.1 Making Short Spin settings

For the Short Spin centrifugation the maximum speed is set by default.

1. To change the speed settings, change the selection under *Settings>Device Settings>Short Spin*.

## 6.2.2 Starting and stopping Short Spin centrifugation

1. To start the Short Spin centrifugation, press and hold the *short* button on the home screen.
  - The centrifugation run starts.
  - The current speed (rpm/rcf) appears.
2. To end the Short Spin centrifugation, release the *short* button.
  - The centrifugation run is ended.
  - The rotor decelerates.
3. To open the lid, press the *Open* button.



The set acceleration ramp/braking ramp does not work during Short Spin centrifugation.

## 6.3 Performing a temperature control run with the Fast Temp function

With the Fast Temp function, you can immediately start a temperature control run without samples, at rotor-specific or temperature-specific speeds. This will quickly bring the rotor chamber, including rotor and adapter, up to the set temperature.

### Prerequisites

- The centrifuge is switched on.
- The rotor has been inserted and attached correctly.
- The buckets and adapters have been inserted correctly.
- The rotor lid has been mounted correctly.
- The buckets can swing out freely.
- The centrifuge lid is closed.

### 6.3.1 Making Fast Temp settings

1. Select the desired temperature in the *Temperature* area on the home screen.

### 6.3.2 Performing a temperature control run

1. Tap the *Fast Temp* button.
  - The temperature control run starts.
  - The display shows the expected duration, the current speed and the message *Preparing Temperature*.
  - The temperature control run ends automatically when the set temperature is reached.
  - The speed decreases.
  - When the temperature control run is finished, the message *Ready* appears in the *Temperature* area and a signal tone sounds.
  - The time that has elapsed since the end of the temperature control run is shown on the display.
2. Confirm the message *Fast Temp finished* to be able to perform other functions.



No parameters can be changed during the temperature control run.



## 7 User administration

### 7.1 The user management concept

User management can be used to organize access to the device. There are three user roles:

- Administrator
- User with standard rights
- User with restricted rights

#### 7.1.1 Administrator

The administrator has additional rights:

- Configuring the device
- Access to user management

#### 7.1.2 User with standard rights

This user is allowed to use the device without restrictions, create new programs and favorites.

#### 7.1.3 User with restricted rights

This user is allowed to use the device with restrictions, e.g., select, start and stop an existing program.

#### 7.1.4 User rights without user management

Without user management, all users have the same rights as an administrator.

#### 7.1.5 User rights

Tasks	User with restricted rights	User with standard rights	Administrator/ user (without user management)
<b>Function related</b>			
Access to Set Point Dialogs	—	x	x
Starting centrifugation	x	x	x
Stop centrifugation	x	x	x
Fast Temp Function start	x	x	x
Short Spin Function start	x	x	x
Open centrifuge	x	x	x

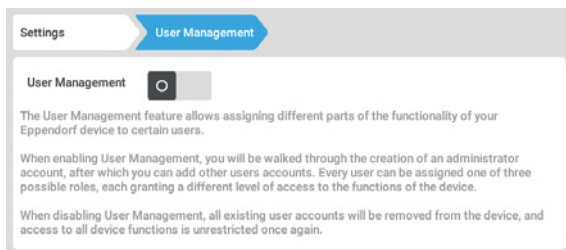
Tasks	User with restricted rights	User with standard rights	Administrator/ user (without user management)
Enable/exit standby	x	x	x
<b>Acknowledge message</b>			
Acknowledge message warning	x	x	x
Acknowledge message alarm	—	x	x
Acknowledge message error	—	x	x
<b>Product-specific features 1 (favorites)</b>			
Access to favorites preview	x	x	x
Load and display favorites	—	x	x
Load favorites function in SP dialog	—	x	x
<b>Product-specific features 2 (programs)</b>			
Access to program selection	x	x	x
Load program	x	x	x
Update parameters	—	x	x
Rename	—	x	x
Program protection (lock/ unlock)	—	x	x
Delete	—	x	x
Display information	x	x	x
<b>Product-specific features 3 (Run Records)</b>			
Access to Full Run Records	x	x	x
Filter	x	x	x
Export	x	x	x
<b>Product-specific device settings</b>			
Short Spin	Read and edit	Read and edit	Read and edit
<b>User settings</b>			
User key in menu	x	x	x
User list with all features	Read	Read	Read
Add user	—	—	x
Remove other users	—	—	x
Change your own user name	—	—	—
Change someone else's user name	—	—	—
Change your own name	x	x	x
Change someone else's name	—	—	x

Tasks	User with restricted rights	User with standard rights	Administrator/ user (without user management)
Change your own e-mail address	x	x	x
Change someone else's e-mail address	—	—	x
Change your own user ID	—	—	x
Change someone else's user ID	—	—	x
Change your own user role	—	—	—
Change your own password/PIN	x	x	x
Reset someone else's password/PIN	—	—	x
<b>General UI features</b>			
Full Event Log	x	x	x
Messages	Read	Read	Read
Clean display	x	x	x
Export	x	x	x
Export information for service	x	x	x
Export all other entries	x	x	x
Contact and support	Read and contact	Read and contact	Read and contact
<b>General settings</b>			
Load setting into menu	x	x	x
about	Read	Read	Read
about/Name	Read	Read	Read and edit
about/Location	Read	Read	Read and edit
about/License information	Read	Read	Read
Device settings/Acoustic signals/Switch	Read	Read	Read and edit
Device settings/Acoustic signals/Test key	x only when switch is active	x only when switch is active	x only when switch is active
Device settings/Display settings	Read and edit	Read and edit	Read and edit
Device settings/Date-time	x	x	x
Device settings/Network	Read	Read	Read and edit
Access to user management	—	—	x
User management/Unrestricted user	n/a	n/a	x
User management/Restricted user	n/a	n/a	x

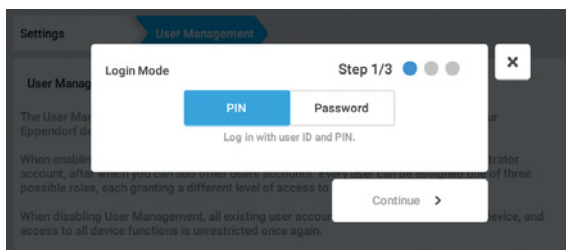
Tasks	User with restricted rights	User with standard rights	Administrator/user (without user management)
User management/Automatic Logout	n/a	n/a	×
User management/Login mode	n/a	n/a	×
User management/Grant all users extra privileges	n/a	n/a	×
Service interface	—	—	—

## 7.2 Setting up user management

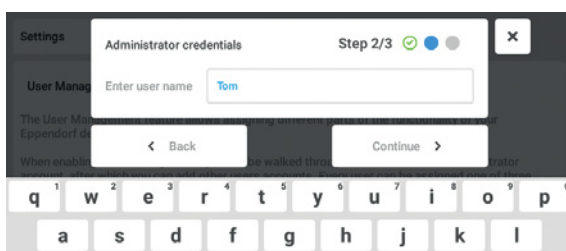
### 7.2.1 Creating an administrator



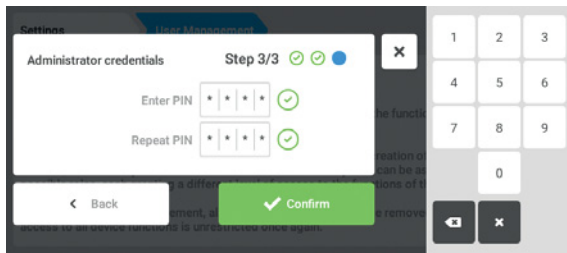
1. Tap the *Menu* button and navigate to the *Settings>User Management* menu item.
2. To enable user management, slide the *User Management* switch to the *I* position. The *Login Mode* window appears.



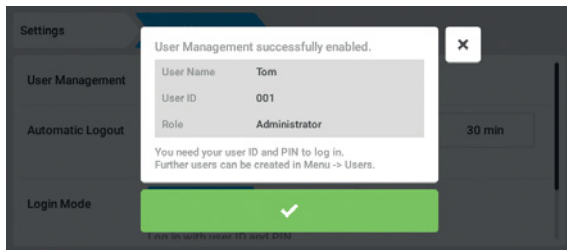
3. Define the login mode for all users.
4. Continue the process with *Continue*. The *Administrator credentials* window appears.



5. Enter the user name for the first administrator in the *Enter User Name* field.
6. Continue the process with *Continue*. The window *Administrator credentials* appears.



7. Enter the PIN or password in the *Enter PIN/Password* field. Confirm the entry via the *Repeat PIN/Password* field.
8. Continue the process with *Continue*.  
The *User Management successfully enabled* window appears.  
User management has been enabled.  
The user account for the first administrator has been created.

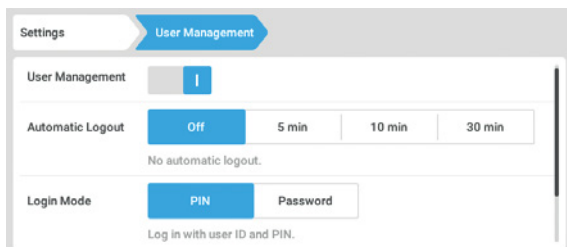


9. Confirm the message.  
The *User Management* window appears.  
It is possible to edit the user management.

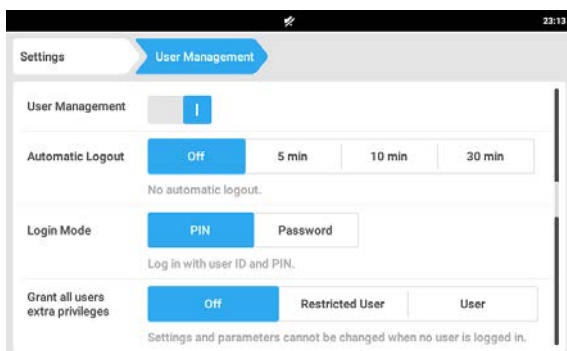
## 7.2.2 Editing the user management

### Prerequisites

- The administrator is logged in.



1. Tap the *Menu* button and navigate to the *Settings>User Management* menu item.



2. Define the settings for user management.

- *User Management*: Switch user management on and off.
- *Automatic Logout*: Define the time after which a user is automatically logged out if the touchscreen is not used.
- *Login Mode*: Define the login mode for all users.
- *Grant all users extra privileges*: Restricted rights (*Restricted User*) or standard rights (*User*) are active for all users.



When the *Grant all users extra privileges* option is enabled a login is not necessary. Even users not registered in the user management can use the device with the rights that have been set (*Restricted User/User*).

### 7.2.3 Disabling user management



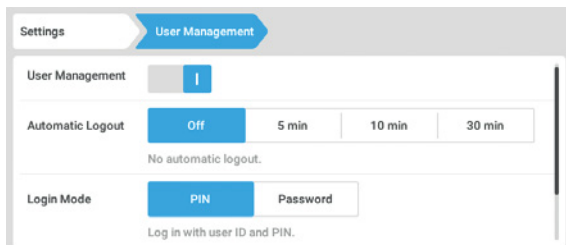
#### NOTICE! Data loss when user management is disabled

Disabling user management deletes all user accounts.

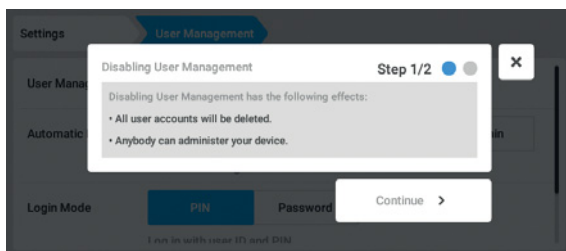
- ▶ Check whether disabling user management is necessary.
- ▶ Inform all users that the user accounts have been deleted.

#### Prerequisites

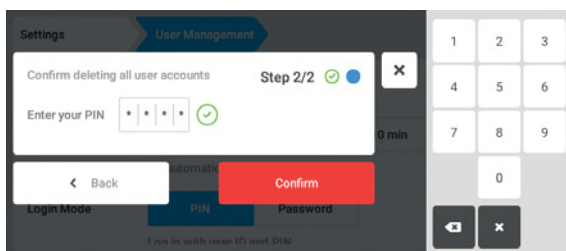
- The administrator is logged in.



1. Tap the *Menu* button and navigate to the *Settings>User Management* menu item.
2. To disable user management, slide the *User Management* switch to the 0 position. The *Disabling User Management* window appears.



3. Continue the process with *Continue*. The *Confirm deleting all user accounts* window appears.



4. Enter the password/PIN.
5. Complete the process with *Continue*. User management is disabled. All user accounts are deleted.

## 7.3 Editing user accounts as administrator



### NOTICE! Data loss due to loss of the administrator password.

The administrator is able to change his password or his PIN only with his access data. If the administrator's access data is lost, it will not be possible to make changes to the user administration or to the system settings.

In this case, the device will have to be reset to the factory settings by an authorized service technician. All user accounts and any data and settings stored on the device will be deleted.

- ▶ Create a second user account with administrator rights.
- ▶ Keep the administrator password secure.

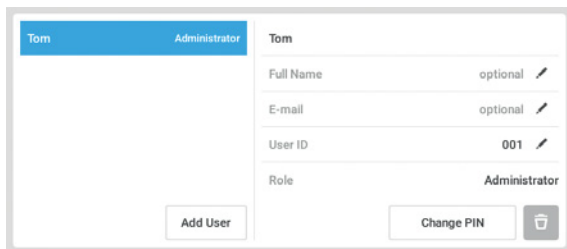
### 7.3.1 Creating a user account



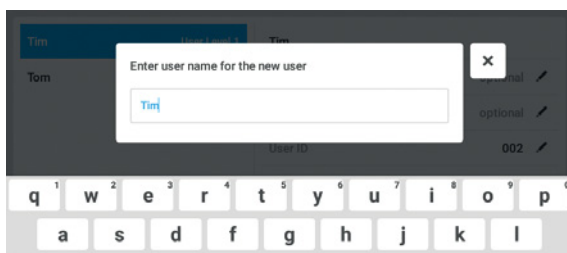
999 user accounts can be created.

#### Prerequisites

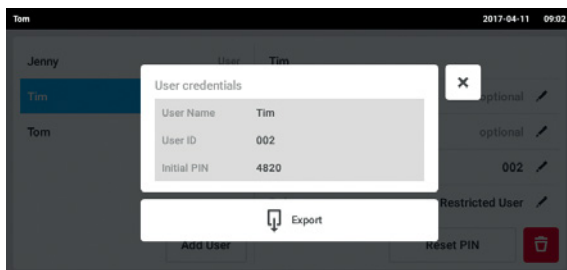
- The administrator is logged in.



1. Tap the *Menu* button and navigate to the *User* menu item.  
The list with the user accounts is displayed.
2. Tap the *Add User* button.  
The *Enter User Name for the new User* field appears.



3. Enter the user name.
4. Confirm the entry.  
The *User credentials* window appears.  
The user account has been created. The user data appears in the window.  
The user has been assigned to the *Restricted User* user group.



5. Optional export of the user data: Connect a USB stick and tap the *Export* button.
6. Confirm the export.  
The user data is exported to the USB stick in a TXT file.
7. If the export was successful, the *Export successful* window appears.  
Confirm the message to complete the process.

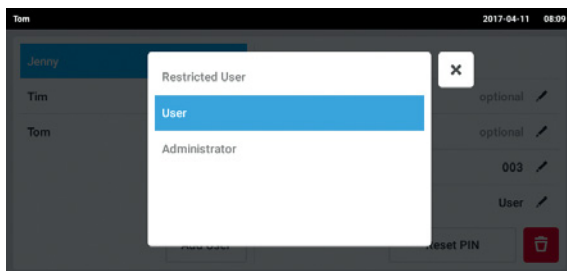
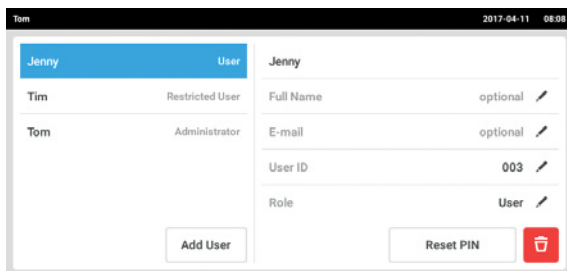
### 7.3.2 Editing user accounts



Users with restricted rights or standard rights can only edit their own entries for *Full Name* and *Do you want e-mail*. Users can always change their own password or the PIN. Administrators can assign a new user ID to a user account and change the user rights.

#### Prerequisites

- The administrator is logged in.



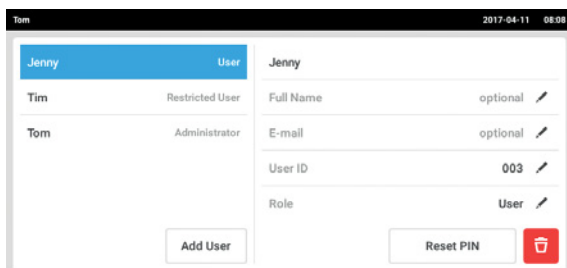
1. Tap the *Menu* button and navigate to the *User* menu item.  
The list with the user accounts is displayed. Editable entries are indicated by a black pen symbol.
2. Select the user account.
3. Optional: Enter the full name.
4. Optional: Enter the e-mail address.
5. Tap User ID to change the user ID.
6. Select a new user ID.
7. Tap *Role* to change the user group and the associated rights.  
The list with the available user groups is displayed.
8. Assign a user group to the user.
  - *Restricted User*
  - *User*
  - *Administrator*

The selected parameters are stored and will appear in the user account.

### 7.3.3 Deleting a user account

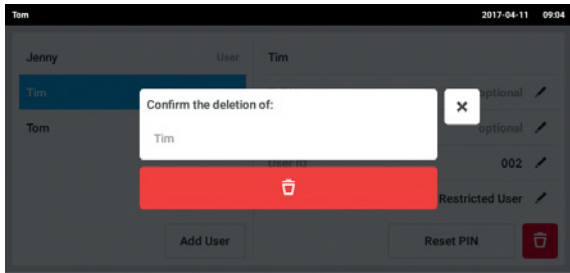
#### Prerequisites

- The administrator is logged in.



1. Tap the *Menu* button and navigate to the *User* menu item.  
The list with the user accounts is displayed.
2. Select the user account that is to be deleted.
3. Tap the *Recycle bin* symbol.  
The *Confirm the deletion of:* window appears.





4. Confirm that you want to delete the user account. The user account is deleted.

### 7.3.4 Resetting the password/PIN for a user account

If a user has forgotten his password/PIN, the administrator can generate a new password/PIN.



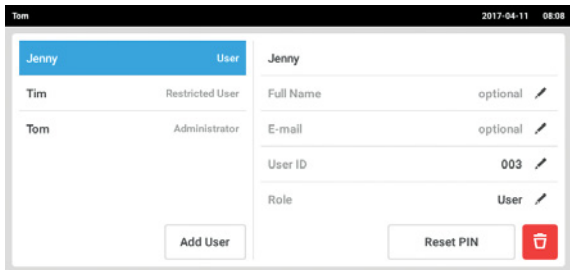
The administrator can only change his password or PIN with his current access data. If the administrator's access data is lost, it will no longer be possible to make any changes in the user management.

In this case, the device will have to be reset to the factory settings by an authorized service technician. This means that all user accounts and programs, log files and logs which are stored on the device will be deleted.

- ▶ Create a second user account with administrator rights.

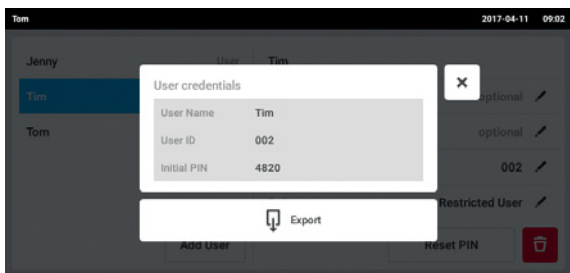
#### Prerequisites

- The administrator is logged in.



1. Tap the *Menu* button and navigate to the *User* menu item. The list with the user accounts is displayed.
2. Select the user account.
3. Tap the *Reset Password/PIN* button. The *to reset the Password/PIN for:* window appears.

4. Tap *Reset* to confirm the action. The *New Credentials* window appears. The new password/PIN is created automatically.



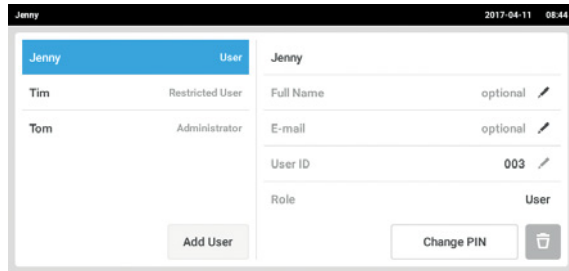
5. To export the user data, connect a USB stick and tap the *Export* button.
6. Confirm the export. The user data is exported to the USB stick in a TXT file.
7. If the export was successful, the *Export successful* window appears. Confirm the message to complete the process.

## 7.4 Managing your own user account

Users can only edit their own *Full Name* and *Do you want e-mail* entries. Users can always change their own PIN or password.

### Prerequisites

- The user is logged in.



1. Tap the *Menu* button and navigate to the *User* menu item.  
The list with the user accounts is displayed. Entries indicated by a black pen can be edited.
2. Select the user account.
3. Optional: Enter the full name.
4. Optional: Enter the e-mail address.
5. To change the password/PIN, tap the *Change Password/PIN* button.
6. Enter the current password/PIN in the *Enter current Password/PIN* field.
7. Enter the new password/PIN in the *Enter new Password/PIN* and *Repeat new Password/PIN* fields.
8. Confirm the entry.  
The *Password/PIN successfully changed* message appears.  
The new password or the new PIN is active.

## 8 Programming

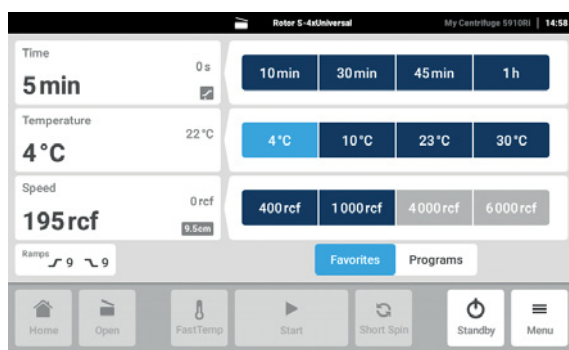
### 8.1 Favorites function



If user management is enabled, the Favorites function is linked to user rights. Users with restricted rights cannot create or modify favorites.

#### 8.1.1 Accessing the Favorites function

The device is delivered with favorites which can all be overwritten by individual favorites.



1. Tap the *Favorites* button on the home screen. The saved favorites for Time, *Temperature* and Speed are displayed.



If a favorite in the *Speed* category is displayed grayed out, the set rotational speed or g-force is not compatible with the rotor used.

#### 8.1.2 Creating a favorite for Time and Speed

Time, Temperature and Speed each specify a permitted value range that cannot be fallen below or exceeded when creating favorites.

In the *Speed* category the favorites can be composed of rpm entries and rcf entries.

1. Enter the parameters for *Set Time*, *Set Temperature* or *Set Speed*.



In *Set Speed* the radius cannot be saved in favorites.

2. Tap *Add to favorites*.
3. Select a position for the favorite entry.
4. Confirm your selection.

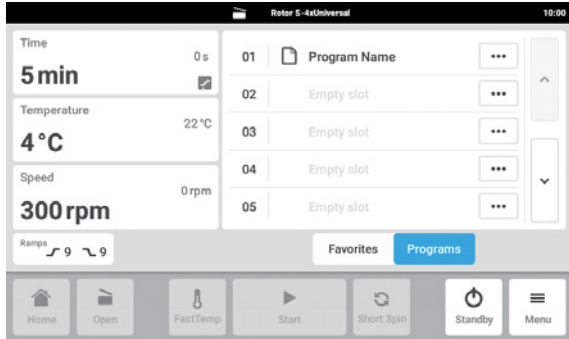
The favorite in the selected position is overwritten.

## 8.2 Programs function



If user management is enabled, the Programs function is linked to user rights. Users with restricted rights can start programs, but not create or modify them.

## 8.2.1 Accessing the Programs function



- ▶ Tap the *Programs* button on the home screen. The list of all programs is displayed.



If programs contain parameters that are not compatible with the rotor used, a red icon with a crossed-out rotor appears behind the program name.

## 8.2.2 Creating a program

99 programs can be created. The order is freely selectable and program entries do not have to follow each other directly.

Prerequisites

- The parameters for Time, Temperature, Speed and Ramps have been set.

1. Tap on an empty program field.
2. Enter the program name.
3. Confirm the entry.

The set parameters are stored in the program.

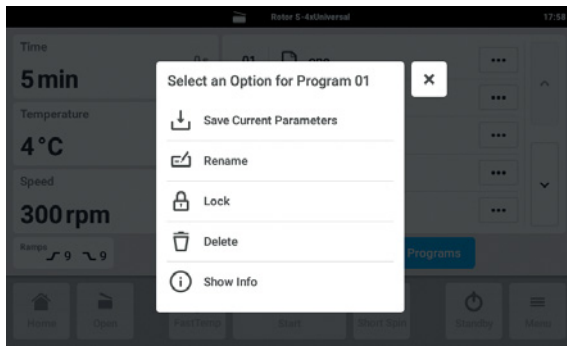
The program appears in the list.

### 8.2.3 Managing programs

A program can be managed via the options menu. The following options are available:

- *Save current parameters*: overwrite the parameters stored in the program with the currently set parameters
- *Rename*: change the name of the program
- *Lock/Unlock*: lock or unlock the program to protect it from being overwritten or enable it to be overwritten
- *Delete*: delete the program
- *Show info*: show the parameters stored in the program

1. Navigate to the corresponding program.
2. Tap the options menu.
3. Select the required option.

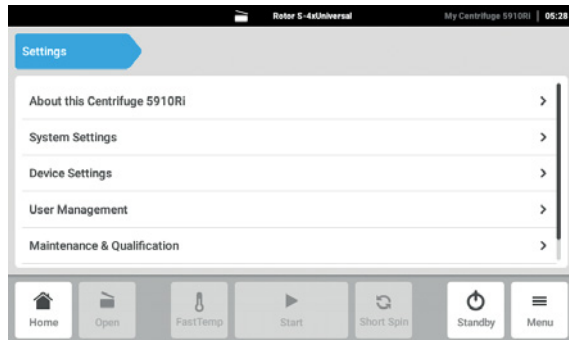


**Programming**

Centrifuge 5910 Ri  
English (EN)

## 9 Settings

### 9.1 Accessing the Settings

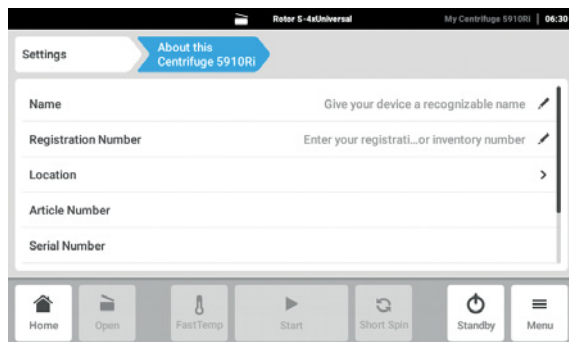


1. Tap the *Menu* button.
2. Tap the *Settings* button.

The following menu items are displayed:

- *About this Centrifuge 5910 Ri*
- *System Settings*
- *Device Settings*
- *User Management*
- *Maintenance and Qualification*

### 9.2 About this Centrifuge 5910 Ri



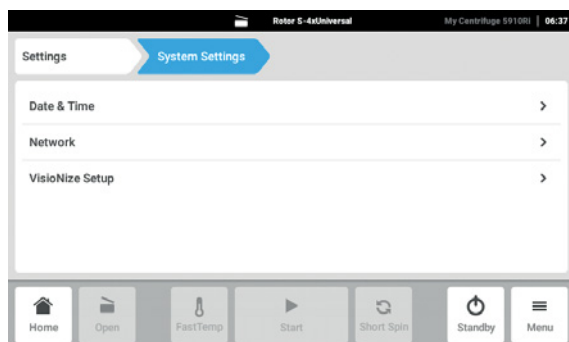
- ▶ Tap the *About this Centrifuge 5910 Ri* button.

The following information can be accessed:

- *Name*: The device name can be entered by the administrator.
- *Registration Number*: The registration number can be entered by the administrator.
- *Location*: Location information can be entered by the administrator.
- *Article Number*
- *Serial Number*
- *Software version*
- *License Information*

## 9.3 System Settings

### 9.3.1 Accessing the System Settings



- ▶ Tap the *System Settings* button.

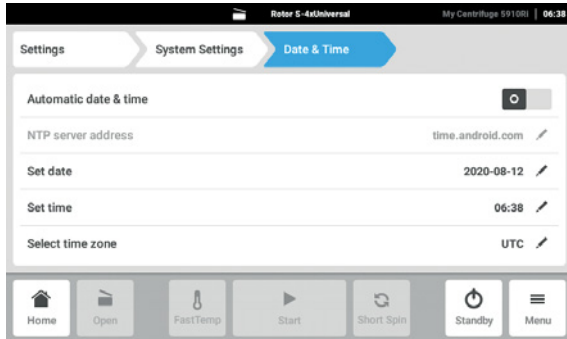
The following settings can be made.

- *Date and Time*: Set the date, time and time zone.
- *Network*: Set the parameters for network operation.

## Settings

Centrifuge 5910 Ri  
English (EN)

### 9.3.2 Accessing the Date and Time Settings



If the date, time or time zone are changed, *Run Records/Event Log* may be sorted incorrectly.



The current local time and the current date must be set on devices which are controlled by the VisioNize software.

#### Setting the date and time automatically

##### Prerequisites

- The device is connected to the network. A time server is available.

1. Tap the *Date and Time* button.
2. Use the *Automatic date and time* switch to activate the function.
3. Tap the *Select time zone* button.
4. Select the continent and the time zone.

#### Setting the date and time manually

1. Tap the *Date and Time* button.
2. Use the *Automatic date and time* switch to disable the function.  
*Set date* and *Set time* can be selected.
3. Tap the *Set date* button and enter the date.
4. Tap the *Set time* button and enter the time.
5. Tap the *Select time zone* button.
6. Select the continent and the time zone.

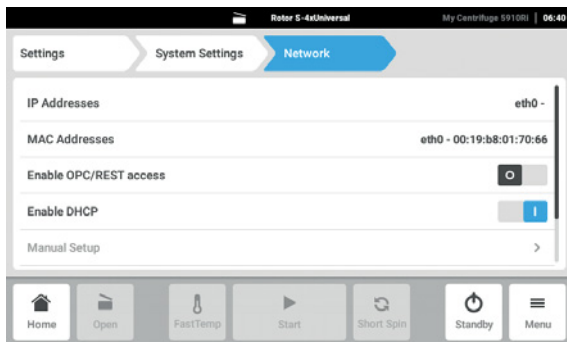


### 9.3.3 Accessing the Network settings



The device can be connected directly to the Internet and to an internal network. An Internet connection is not required for operation. If the device is connected to the Internet, the owner is responsible for data security.

- ▶ A connection to the internal network or the Internet may only be established by a network administrator.
- ▶ Check the settings for the internal network or the Internet before establishing a connection.



1. Tap the *Network* button.

The following settings can be made.

- *IP Addresses*: Current IP address of the device.
- *MAC Addresses*: Number which uniquely identifies the device in the network.
- *Enable OPC/REST access*: The device allows communication with an external software via OPC or REST.
- *Enable DHCP*: The device uses an IP address which was assigned to it by an existing DHCP server.
- *Manual Setup*: Enables a window. This window can be used to enter the network settings manually if no DHCP server is available. Manual Setup can only be selected if automatic IP address assignment (Enable DHCP) is disabled.
- *Self-signed certificate*: This function is intended only for authorized service personnel.
- *Extended network log*: This function is intended only for authorized service personnel.

### 9.3.4 Activating Manual Setup

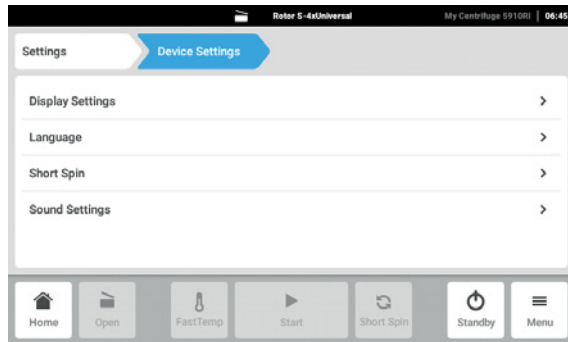
1. Deactivate the *Enable DHCP* function via the switch.  
*Manual Setup* can be selected.
2. Tap the *Manual Setup* button.
3. Complete the entries in the input window and confirm.

## Settings

Centrifuge 5910 Ri  
English (EN)

## 9.4 Device Settings

### 9.4.1 Accessing the Device Settings

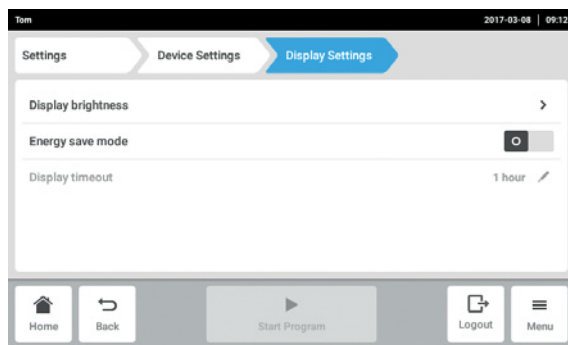


- ▶ Tap the *Device Settings* button.

The following settings can be made.

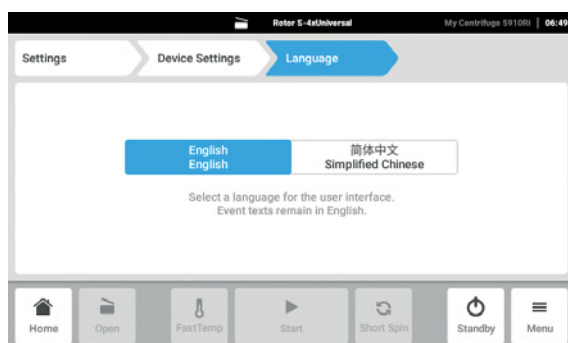
- *Display Settings*: Setting the brightness and power saving mode.
- *Language*: Select the language for the user interface.
- *Short Spin*: Set a specific rotor rotational speed or select the maximum rotor rotational speed.
- *Sound Settings*: Enable/disable the acoustic alarm and the end-of-program sound.

### 9.4.2 Display Settings



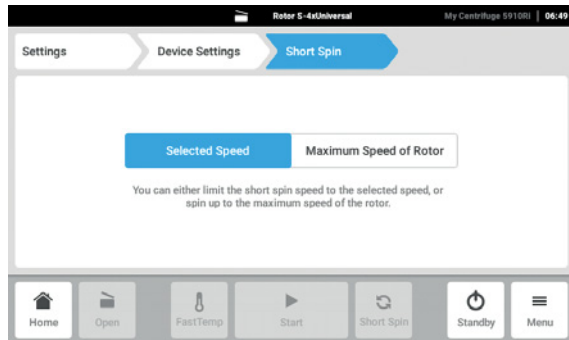
1. Tap the *Display Settings* button.  
A selection list for setting the *Display brightness*, *Energy save mode* and *Display timeout* appears.
2. Tap the *Display brightness* button.  
The slider control bar for the brightness setting is displayed.
3. Set the brightness.
4. Use the *Energy save mode* switch to enable or disable the power saving mode.  
When the *Energy save mode* is enabled, the *Display timeout* button becomes active.
5. Tap *Display timeout*.  
A window for entering the time appears.
6. Enter the time.  
The brightness of the display is dimmed if there is no input during the selected interval.

### 9.4.3 Language



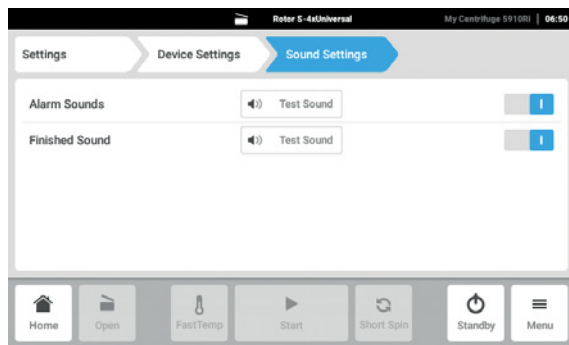
1. Tap the *Language* button.  
The language selection for the user interface is displayed.
2. Select the required language.
3. Switch the centrifuge off and back on.  
New text modules for the selected language are loaded.

## 9.4.4 Short Spin



1. Tap the *Short Spin* button.  
The selection for the rotor rotational speed is displayed.
2. Select the entered rotor rotational speed or the maximum rotor rotational speed.  
The *Short Spin* function is performed with the selected rotor rotational speed.

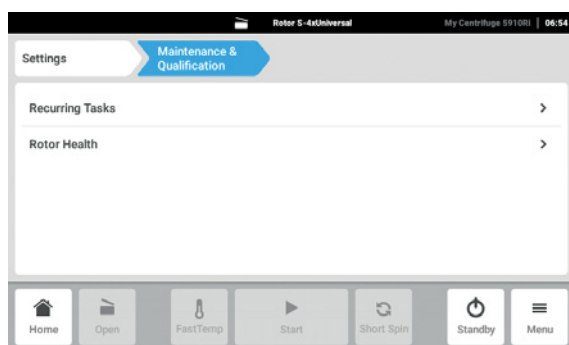
## 9.4.5 Sound Settings



1. Tap the *Sound Settings* button.
2. Enable or disable the acoustic alarm.
3. Enable or disable the signal tone for the end of the program.

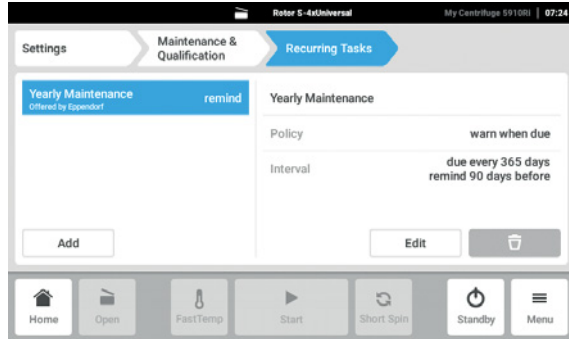
## 9.5 Adding service intervals

### 9.5.1 Accessing Maintenance and Qualification



- ▶ Tap the *Maintenance and Qualification* button.  
The following selection appears:
  - *Recurring Tasks*: Add service interval.
  - *Rotor Health*: Display information on the number of cycles of the rotors.

## 9.5.2 Adding Recurring Tasks



1. Tap the *Recurring Tasks* button.
2. Tap the *Add* button.
3. Enter a name for the new service task and confirm with *next*.
4. Enable the *Task Policy* function and confirm with *Continue*.
5. Enter the time interval for the service task and confirm with the *finish* button.  
The new service interval is displayed in the selection list on the left-hand side.
6. Tap the *Edit* button.  
The *Task Policy* selection window for the activation of the service reminder is displayed.
7. Enable or disable the service reminder and confirm the selection with *Continue*.
8. Set the time interval for the service task and confirm with *finish*.  
The service interval with the time and reminder information appears in the list.

## 9.5.3 Rotor Health

The centrifuge automatically detects the rotor type when the rotor is turned manually. The maximum number of cycles of the rotors is set by the manufacturer and cannot be changed. The number of cycles completed can be queried in the *Maintenance and Qualification* menu.

## 10 Maintenance

### 10.1 Service options

Eppendorf recommends having your device checked and maintained by trained specialist personnel at regular intervals.

Eppendorf offers you tailor-made service solutions for the preventive maintenance, qualification and calibration of your device. For information, offers and contact options, please visit [www.eppendorf.com/epservices](http://www.eppendorf.com/epservices).

### 10.2 Service

---



**WARNING! Risk of injury due to defective gas spring(s).**

A defective gas spring provides insufficient support for the centrifuge lid. There is a risk of crushing fingers or limbs.

- ▶ Make sure that the centrifuge lid can be opened fully and that it will remain in this position.
- ▶ Regularly check all gas springs for their proper function.
- ▶ Have defective gas springs replaced immediately.
- ▶ Have gas springs replaced by a service technician every 2 years.



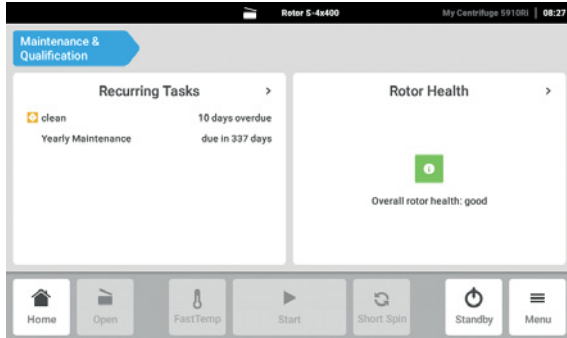
**WARNING! Risk of fire or electrical shock**

- ▶ Have the centrifuge's electrical safety, especially the continuity of the protective connections, checked every 12 months by trained and skilled personnel.
- 

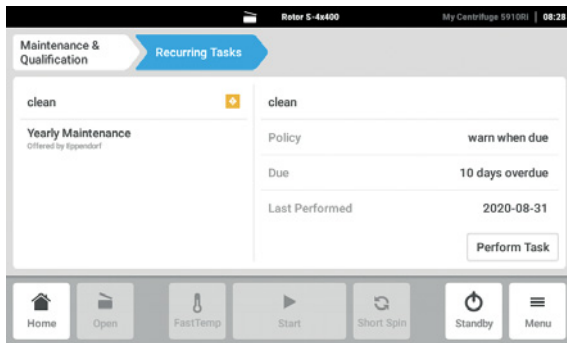
In the *Maintenance and Qualification*>*Recurring Tasks* menu, the service intervals stored under *Settings*>*Maintenance and Qualification*>*Recurring Tasks* can be called and confirmed.

## 10.2.1 Confirming Recurring Tasks

1. Tap *Settings Maintenance and Qualification* in the menu.



2. Select the *Recurring Tasks* area.



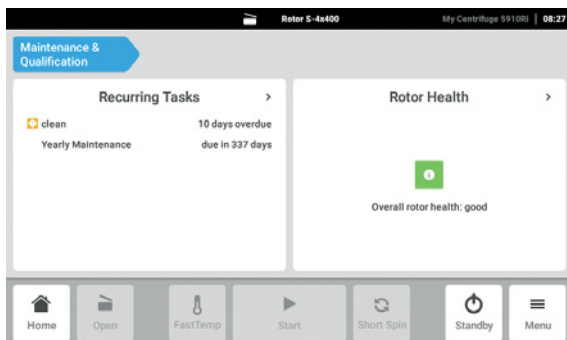
Information on the selected service work is displayed.

3. Tap the *Perform Task* button to confirm the service work performed and reset the service interval.

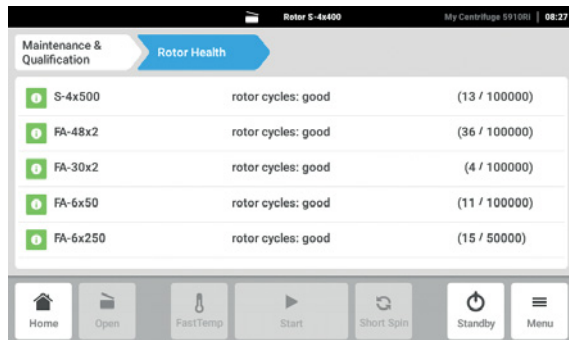
We recommend to have the centrifuge and the associated rotors checked by Technical Service during a service at least every 12 months. Please note the country-specific regulations.

## 10.2.2 Displaying Rotor Health

1. Tap *Settings Maintenance and Qualification* in the menu.



2. Select the *Rotor Health* area.



A list of the rotors used so far appears with the number of cycles completed.

### 10.3 Prepare cleaning/disinfection

- ▶ Clean all accessible surfaces of the device and the accessories at least weekly and when contaminated.
- ▶ Clean the rotor regularly. This way the rotor is protected and the durability is prolonged.
- ▶ Furthermore, observe the notes on decontamination (see *Decontamination before shipment on p. 80*) when the device is sent to the authorized Technical Service for repairs.

The procedure described in the following chapter applies to the cleaning as well as to the disinfection or decontamination. The table below describes the steps required on top of this:

Cleaning	Disinfection/decontamination
<ol style="list-style-type: none"> <li>1. Use a mild cleaning fluid to clean the accessible surfaces of the device and the accessories.</li> <li>2. Carry out the cleaning as described in the following chapter.</li> </ol>	<ol style="list-style-type: none"> <li>1. Choose the disinfection method which corresponds to the legal regulations and guidelines in place for your range of application. For example, use alcohol (ethanol, isopropanol) or alcohol-based disinfectants.</li> <li>2. Carry out the disinfection or decontamination as described in the following chapter.</li> <li>3. Then clean the device and the accessories.</li> </ol>



If you have any further questions regarding cleaning and disinfection or decontamination or regarding the cleaning agents to be used, contact the Application Support of Eppendorf SE. The contact details are provided on the back of this manual.

## 10.4 Performing cleaning/disinfection

---



### **DANGER! Electric shock due to the ingress of liquid.**

- ▶ Switch off the device and disconnect it from the mains/power line before commencing any cleaning or disinfection procedures.
- ▶ Do not allow any liquids to enter the inside of the housing.
- ▶ Do not spray clean or spray disinfect the housing.
- ▶ Only reconnect the device to the mains/power line when it is completely dry, both inside and outside.



### **NOTICE! Danger due to deformed or brittle tubes. Autoclaving at excessively high temperatures can lead to plastic vessels becoming brittle and deformed.**

This could result in damage to the device and the accessories and sample loss.

- ▶ Observe the temperatures specified by the manufacturer when autoclaving tubes.
- ▶ Do not use any deformed or brittle tubes.



### **NOTICE! Damage due to aggressive chemicals.**

- ▶ Do not use any aggressive chemicals on the device or its accessories, such as strong and weak bases, strong acids, acetone, formaldehyde, halogenated hydrocarbons or phenol.
- ▶ If the device has been contaminated by aggressive chemicals, clean it immediately using a mild cleaning agent.



### **NOTICE! Corrosion due to aggressive cleaning agents and disinfectants.**

- ▶ Do not use any corrosive cleaning agents, aggressive solvents or abrasive polishes.
- ▶ Do not incubate the accessories in aggressive cleaning agents or disinfectants for longer periods.



### **NOTICE! Damage from UV and other high-energy radiation.**

- ▶ Do not use UV, beta or gamma rays or any other high-energy forms of radiation for disinfection.
- ▶ Avoid storage in areas with high UV radiation levels.



### **Autoclaving**

Fixed-angle rotors, rotor lids, adapters, and buckets can be autoclaved (121 °C, 20 min).

Rotor crosses of swing-bucket rotors cannot be autoclaved.

Replace the seal on aerosol-tight rotor lids and aerosol-tight caps after 50 autoclaving cycles.





### **Aerosol tightness**

Check that the seals are intact before use.

Replace the sealing rings or the rotor lids with screw cap when the sealing rings on the lid screw and in the lid groove become worn.

Regular care of the sealing rings is necessary in order to protect the rotors.

Aerosol-tight rotors should never be stored with the lids screwed on!

In order to prevent damage, lightly grease the lid threads of aerosol-tight rotors regularly with pivot grease (order no. int.: 5810 350.050/North America: 022634330).

## **10.4.1 Cleaning and disinfecting the device**

### **Recommended cleaning agents:**

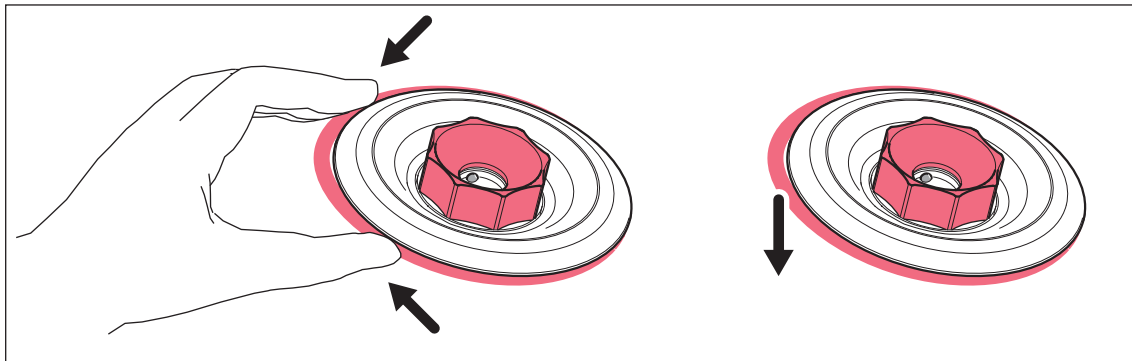
- Alcohol 70 % (ethanol, isopropanol)
- Mild neutral cleaning agent

1. Open the lid. Switch the device off at the mains/power switch. Disconnect the mains/power plug from the voltage supply.
2. Remove the rotor.
3. Clean and disinfect all accessible surfaces of the device, including the mains/power cord, using a damp cloth and the recommended cleaning agents.
4. Thoroughly clean the rubber seal of the rotor chamber with water.
5. Rub the dry rubber seal with glycerol to prevent it from becoming brittle. Other components of the device, such as the motor shaft and rotor cone, must not be lubricated.
6. Clean the motor shaft with a soft, dry, lint-free cloth. Do not grease the motor shaft.
7. Inspect the motor shaft for damage.
8. Inspect the device for corrosion and damage.
9. Leave the centrifuge lid open when the device is not being used.
10. Only reconnect the device to the mains/power supply if it is fully dry on the inside and outside.

### 10.4.2 Cleaning and disinfecting the rotor

1. Inspect the rotor and accessories for damage and corrosion. Do not use any damaged rotors or accessories.
2. Clean and disinfect the rotors and accessories with the recommended cleaning agents.
3. Clean and disinfect the rotor bores with a bottle brush.
4. Clean and disinfect the rotor lid.

**QuickLock rotor lids:** Remove the sealing ring. Clean the sealing ring and the groove below it.



5. Rinse the rotors and accessories thoroughly with distilled water. Rinse the rotor bores of fixed-angle rotors particularly thoroughly.



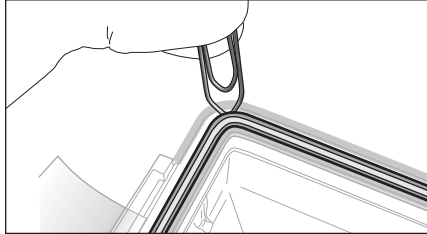
Do not immerse the rotor in liquid as liquid can get trapped inside the cavities.

6. Place the rotors and accessories on a towel to dry. Place the fixed-angle rotors with the rotor bores facing down so the bores can dry.
7. Coat the sealing ring of the rotor lid with a thin layer of pivot grease and correctly reinsert it in the clean and dry groove.
8. Clean the rotor cone with a soft, dry, lint-free cloth. Do not lubricate the rotor cone.
9. Inspect the rotor cone for damage.
10. Place the dry rotor onto the motor shaft.
11. Tighten the rotor nut firmly by turning it **clockwise** with the rotor key.
12. Leave the rotor lid open when the rotor is not being used.

### 10.4.3 Changing the seal of the aerosol-tight cap

To clean the aerosol-tight cap, remove the seal of the aerosol-tight cap.

### 10.4.3.1 Removing the seal



1. Use a blunt lever to lift the seal out of the groove (e.g., use the round side of a paper clip). Make sure not to damage the seal with the wire ends.
2. Carefully lift the seal out of the groove.

### 10.4.3.2 Inserting the seal



**NOTICE! Faulty sealing if the seal is handled incorrectly.**

- ▶ Insert the seal evenly.
- ▶ Do not pull the seal lengthwise.

1. Check that the seal is not damaged.  
Do not use any damaged, discolored or dirty seals.
2. Place the seal on the groove and slightly press it into the groove.
3. Place the cap on the bucket and close it completely.
4. Remove the cap and check the correct positioning of the seal.



If the seal is too long or too short, remove the seal from the groove. Insert the seal again.

## 10.5 Additional care instructions for refrigerated centrifuges.

- ▶ Regularly defrost the rotor chamber for the refrigerated devices, either by leaving the centrifuge lid open or carrying out a brief temperature control run at approx. 30 °C.
- ▶ To relieve the gas springs in the centrifuge lid, leave the centrifuge lid open when not in use for a long period.  
Residual moisture can escape.
- ▶ Wipe up condensation water in the rotor chamber. Use a soft absorbent cloth for this.



Leave the centrifuge lid open in order to allow the condensation water to evaporate.

- ▶ No later than every 6 months, remove any dust deposits from the ventilation gaps of the centrifuge using a brush or swab. First switch off the centrifuge and remove the mains/power plug.

## 10.6 Cleaning glass breakage

When using glass tubes there is a risk of glass breakage in the rotor chamber. The resulting glass splinters are swirled around in the rotor chamber during centrifugation and have a sandblasting effect on the rotor and accessories. The smallest glass particles become lodged in the rubber parts (e.g., the motor guide, the rotor chamber seal, and the rubber mats of adapters).



### **NOTICE! Glass breakage in the rotor chamber**

Glass tubes in the rotor chamber may break if the  $g$ -force is too high. Broken glass can damage the rotor, accessories and samples.

- ▶ Please note the manufacturer's information on the recommended centrifugation parameters (load and speed).

### **Effects of glass breakage in the rotor chamber:**

- Fine black metal abrasion in the rotor chamber (in metal rotor chambers)
- The surfaces of the rotor chamber and accessories are scratched.
- The chemical resistance of the rotor chamber is reduced.
- Contamination of samples
- Wear on rubber parts

### **How to proceed in case of glass breakage**

1. Remove all splinters and glass powder from the rotor chamber and accessories.
2. Thoroughly clean the rotor and rotor chamber. Thoroughly clean the bores of the fixed-angle rotors, in particular.
3. If required, replace the rubber mats and adapters to prevent any further damage.
4. Regularly check the rotor bores for deposits and damage.

## 10.7 Resetting the excess current switch

Thermal excess current switches are mounted as fuses. If the excess current protection is triggered, they set the switch to OFF. However, they do not automatically switch it on again.

To switch on the excess current switch again, proceed as follows:

1. Switch off the centrifuge using the mains/power switch.
2. Wait for at least 20 s and switch on the centrifuge again.

The excess current switch is reactivated and the centrifuge is ready for operation.

## 10.8 Decontamination before shipment

If you are shipping the device to the authorized Technical Service for repairs or to your authorized dealer for disposal please note the following:



**WARNING! Risk to health from contaminated device.**

1. Observe the information in the decontamination certificate. It is available as a PDF document on our webpage (<https://www.eppendorf.com/decontamination>).
2. Decontaminate all the parts to be shipped.
3. Include the fully completed decontamination certificate in the shipment.

## 10.9 Performing a software update

### Checking the software version on the device

1. Check which software version is installed on the device. Tap the *Menu>Settings>About this Centrifuge 5910 Ri* menu path.

The software version is displayed under *Software version*.

### Requesting a software update

2. Request the data for the software update from your local Eppendorf partner. The address can be found on the Internet at [www.eppendorf.com](http://www.eppendorf.com).
3. Save the **update.zip** file with the software update on a USB stick.
4. Unzip the **update.zip** file.



- The device has only access to data on the top level of the USB stick.
- Do not save the data in a folder.

### Performing a software update

5. Connect the USB stick with the software update to the device.
6. Switch on the device.

The Centrifuge 5910 Ri is started from the USB stick.

7. Follow the instructions on the device until the software update is complete.



Do not abort the software update. If the update is stopped, this will result in loss of data and the device will have to be reset to the factory settings. If this happens contact the authorized service.



## 11 Troubleshooting

### 11.1 General errors

Technical faults may be triggered by faults such as a mains/power failure or mains/power fluctuations.

In most cases one of the following measures is sufficient:

#### 11.1.1 Restarting the software

- ▶ Switch off the device and switch it back on after approx. 10 seconds.

#### 11.1.2 Checking the cable connections

1. Switch off the device.
2. Check the cable connections.
3. Switch on the device.

#### 11.1.3 Entering contacts

Information on your Eppendorf partners can be entered in this area.

##### 11.1.3.1 Contacts and Support

1. Tap the *Menu* button.
2. Tap the *Contacts and Support* button.

A selection list appears.

- *Contact*: Saving service contacts is possible.
- *Diagnostics*: Product-specific information can be called up by the customer under the guidance of the service department.

Alternatively, you can find your local Eppendorf partner on the Internet at [www.eppendorf.com](http://www.eppendorf.com).

## 11.2 Emergency release

If the centrifuge lid cannot be opened, you can activate the emergency release manually.



**WARNING! Risk of injury from rotating rotor.**

If the emergency release of the lid is operated, the rotor may continue to rotate for several minutes.

- ▶ Wait for the rotor to stop before activating the emergency release.
  - ▶ To check, look through the monitoring glass in the centrifuge lid.
- 

Use the rotor key delivered with the Centrifuge 5910 Ri for the emergency release. Carry out the following steps on both the left side and right side of the centrifuge.

1. Pull out the mains/power plug and wait for the rotor to stop.
2. Insert the rotor key into the hexagonal opening on one side of the centrifuge until noticeable resistance can be felt.
3. Slightly press and turn the rotor key **counterclockwise**.
4. Insert the rotor key into the hexagonal opening on the opposite side of the centrifuge until noticeable resistance can be felt.
5. Slightly press and turn the rotor key **counterclockwise**.  
This will release the centrifuge lid.
6. Open the centrifuge lid.



## 12 Transport, storage and disposal

### 12.1 Transport



**CAUTION! Risk of injury due to lifting and carrying heavy loads.**

The device is heavy. Lifting and carrying the device can lead to back injuries.

- ▶ Transport and lift the device with an adequate number of helpers.
- ▶ Use a transport aid to transport the device.

- ▶ Remove the rotor from the centrifuge before transport.
- ▶ Use the original packaging and the transport securing devices for transport.

	Air temperature	Relative humidity	Atmospheric pressure
General transport	-25 °C – 60 °C	10 % – 75 %	30 kPa – 106 kPa
Air freight	-20 °C – 55 °C	10 % – 75 %	30 kPa – 106 kPa

### 12.2 Storage

	Air temperature	Relative humidity	Atmospheric pressure
In transport packing	-25 °C – 55 °C	10 % – 75 %	70 kPa – 106 kPa
Without transport packing	-5 °C – 45 °C	10 % – 75 %	70 kPa – 106 kPa

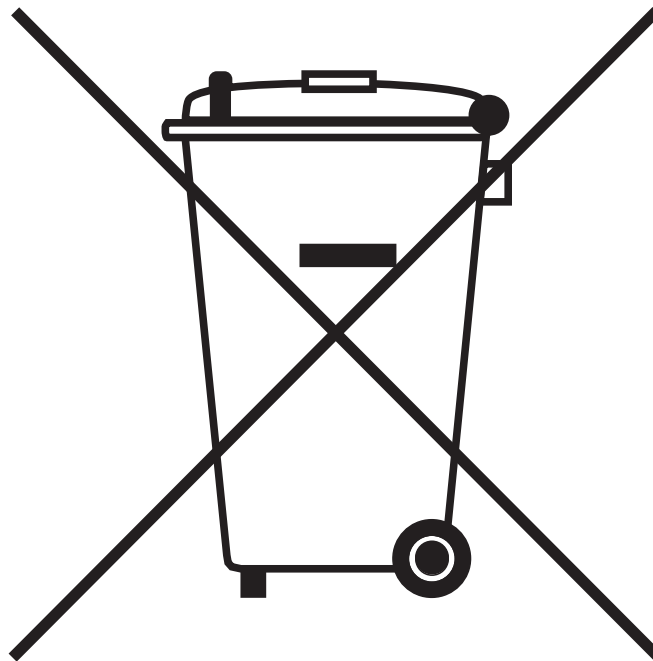
## 12.3 Disposal

Observe the relevant legal regulations when disposing of the product.

### **Information on the disposal of electrical and electronic devices in the European Community:**

Within the European Community, the disposal of electrical devices is regulated by national regulations based on EU Directive 2012/19/EU pertaining to waste electrical and electronic equipment (WEEE).

According to these regulations, any devices supplied after August 13, 2005, in the business-to-business sphere, to which this product is assigned, may no longer be disposed of in municipal or domestic waste. They are marked with the following symbol to indicate this:



As the disposal regulations may differ from one country to another within the EU, please contact your supplier for more information.

## 13 Technical data

### 13.1 Power supply

Mains/power connection	230 V, 50 Hz – 60 Hz 120 V, 50 Hz – 60 Hz 100 V, 50 Hz – 60 Hz
Current consumption	230 V: 10.5 A 120 V: 12 A 100 V: 15 A
Power consumption	230 V: Maximum 1650 W 120 V: Maximum 1440 W 100 V: Maximum 1500 W
EMC: Noise emission (radio interference)	230 V: IEC 61326-1/CISPR 11/EN 61326-1/EN 55011 – Class A 120 V: CFR 47 FCC Part 15 – Class A 120 V: IEC 61326-1/CISPR 11 – Class A 100 V: IEC 61326-1/CISPR 11 – Class A
EMC: Noise immunity	IEC 61326-1/EN 61326-1 industrial electromagnetic environment
Overvoltage category	II
Pollution degree	2

### 13.2 Weight/dimensions

Dimensions	Width: 71.5 cm Depth: 62.0 cm/68.0 cm Height: 36.8 cm/85.0 cm
Weight without rotor	109 kg

Rotor weights:		Accessories without caps:	
S-4xUniversal	6790 g	Universal bucket	920 g
S-4x750	5100 g	Round bucket	605 g
		DWP bucket	700 g
S-4x500	5400 g	Bucket	585 g
		Flex bucket	810 g
		Form bucket 7x50	880 g
S-4x400	5200 g	Round bucket	490 g
FA-6x250	5300 g		
FA-6x50	3300 g		
FA-48x2	2500 g		
FA-20x5	2800 g		
FA-30x2	1800 g		
F-48x15	2100 g	Sleeve	30 g

### 13.3 Noise level

The noise level was measured frontally in a sound measuring chamber with accuracy class 1 (DIN EN ISO 3745) at a distance of 1 m from the device and at lab bench height.

	<b>Swing-bucket rotor</b>	<b>Fixed-angle rotor</b>
Noise level at maximum rotor speed	< 53 dB(A) (S-4xUniversal) < 57 dB(A) (S-4x750)	< 59 dB(A) (FA-6x50)

### 13.4 Ambient conditions

Environment	For indoor use only
Ambient temperature	10 °C – 35 °C
Relative humidity	10 % – 75 %, non-condensing
Atmospheric pressure	79.5 kPa – 106 kPa Use up to a height of 2 000 m above sea level.

### 13.5 Application parameters

Run time	10 s – 99:59 h, infinite ( $\infty$ ), • can be set in increments of 1 s
Temperature	-11 °C – 40 °C
Relative centrifugal force	$1 \times g$ – $22\,132 \times g$ • can be set in increments of $1 \times g$
Rotational speed	10 rpm – 14 000 rpm • can be set in increments of 1 rpm
Maximum load	Fixed-angle rotor: $6 \times 250$ mL Swing-bucket rotors: $4 \times 1000$ mL
Maximum kinetic energy	36 400 J
Permitted density of the material for centrifuging (at maximum $g$ -force (rcf) or rotational speed (rpm) and maximum load)	1.2 g/mL 1.0 g/mL for rotor FA-6x250
Inspection obligation in Germany	Yes

## 13.6 Temperatures

All rotors of the Centrifuge 5910 Ri safely maintain a temperature of  $4\text{ °C} \pm 2\text{ °C}$  at maximum rpm.

The rotor S-4x750 in combination with the device variant for 120 V is an exception for the Centrifuge 5910 Ri:

Centrifuge	Rotor	Temperature at max. rpm	rpm for safe temperature maintenance at $4\text{ °C} \pm 2\text{ °C}$
Centrifuge 5910 Ri100 V	S-4x750	$4\text{ °C} \pm 2\text{ °C}$	n/a
Centrifuge 5910 Ri120 V	S-4x750 round bucket	$6\text{ °C} \pm 2\text{ °C}$	4400 rpm
Centrifuge 5910 Ri230 V	S-4x750	$4\text{ °C} \pm 2\text{ °C}$	n/a

To safely maintain a temperature of  $4\text{ °C}$  at an ambient temperature of  $23\text{ °C}$ , the speed must be reduced to 4 400 rpm.

## 13.7 Acceleration and deceleration times

The following table contains acceleration times and deceleration times of the rotors for the Centrifuge 5910 Ri. The data was determined with the rotor at maximum load. Fluctuations may occur depending on the condition of the device and the load.

- Level 9: shortest acceleration time/deceleration time
- Level 0: longest acceleration time/deceleration time (with the brake off)

Rotor		0	1	2	3	4	5	6	7	8	9
<b>S-4xUniversal</b> (230 V, 120 V)	Acceleration time	≤506 s	≤294 s	≤219 s	≤152 s	≤114 s	≤91 s	≤85 s	≤78 s	≤73 s	≤69 s
	Deceleration time	≤1609 s	≤706 s	≤282 s	≤192 s	≤129 s	≤97 s	≤80 s	≤68 s	≤62 s	≤54 s
<b>S-4xUniversal</b> (100 V)	Acceleration time	≤911 s	≤484 s	≤346 s	≤337 s	≤167 s	≤131 s	≤113 s	≤97 s	≤88 s	≤78 s
	Deceleration time	≤1351 s	≤495 s	≤357 s	≤192 s	≤130 s	≤94 s	≤82 s	≤71 s	≤66 s	≤63 s
<b>S-4x750</b> (230 V, 120 V)	Acceleration time	≤406 s	≤257 s	≤194 s	≤130 s	≤96 s	≤76 s	≤62 s	≤54 s	≤48 s	≤41 s
	Deceleration time	≤1017 s	≤383 s	≤247 s	≤165 s	≤112 s	≤87 s	≤74 s	≤59 s	≤49 s	≤39 s
<b>S-4x750</b> (100 V)	Acceleration time	≤951 s	≤491 s	≤384 s	≤298 s	≤172 s	≤124 s	≤108 s	≤90 s	≤79 s	≤66 s
	Deceleration time	≤1223 s	≤494 s	≤231 s	≤157 s	≤108 s	≤83 s	≤68 s	≤57 s	≤51 s	≤44 s

Rotor		0	1	2	3	4	5	6	7	8	9
<b>S-4x500</b> (230 V, 120 V)	Acceleration time	≤345 s	≤218 s	≤165 s	≤110 s	≤82 s	≤65 s	≤53 s	≤46 s	≤40 s	≤33 s
	Deceleration time	≤771 s	≤360 s	≤210 s	≤138 s	≤100 s	≤76 s	≤58 s	≤49 s	≤44 s	≤35 s
<b>S-4x500</b> (100 V)	Acceleration time	≤880 s	≤455 s	≤356 s	≤232 s	≤160 s	≤116 s	≤97 s	≤84 s	≤72 s	≤57 s
	Deceleration time	≤932 s	≤375 s	≤215 s	≤145 s	≤101 s	≤76 s	≤62 s	≤54 s	≤45 s	≤39 s
<b>S-4x400</b> (230 V, 120 V)	Acceleration time	≤406 s	≤260 s	≤189 s	≤126 s	≤91 s	≤68 s	≤59 s	≤48 s	≤43 s	≤35 s
	Deceleration time	≤860 s	≤386 s	≤231 s	≤164 s	≤114 s	≤82 s	≤70 s	≤57 s	≤50 s	≤40 s
<b>S-4x400</b> (100 V)	Acceleration time	≤1132 s	≤583 s	≤455 s	≤297 s	≤203 s	≤146 s	≤121 s	≤102 s	≤86 s	≤67 s
	Deceleration time	≤861 s	≤370 s	≤240 s	≤167 s	≤118 s	≤85 s	≤72 s	≤62 s	≤53 s	≤43 s
<b>FA-6x250</b> (230 V)	Acceleration time	≤900 s	≤561 s	≤420 s	≤276 s	≤202 s	≤155 s	≤123 s	≤105 s	≤89 s	≤71 s
	Deceleration time	≤1700 s	≤503 s	≤340 s	≤235 s	≤165 s	≤114 s	≤95 s	≤82 s	≤67 s	≤51 s
<b>FA-6x250</b> (120 V)	Acceleration time	≤890 s	≤560 s	≤419 s	≤276 s	≤202 s	≤155 s	≤124 s	≤105 s	≤88 s	≤70 s
	Deceleration time	≤1688 s	≤547 s	≤350 s	≤242 s	≤166 s	≤117 s	≤97 s	≤79 s	≤66 s	≤51 s
<b>FA-6x250</b> (100 V)	Acceleration time	≤2244 s	≤1158 s	≤904 s	≤564 s	≤403 s	≤289 s	≤240 s	≤198 s	≤166 s	≤124 s
	Deceleration time	≤1523 s	≤537 s	≤343 s	≤244 s	≤164 s	≤117 s	≤97 s	≤79 s	≤66 s	≤51 s
<b>FA-6x50</b> (230 V, 120 V)	Acceleration time	≤351 s	≤239 s	≤176 s	≤121 s	≤90 s	≤68 s	≤60 s	≤51 s	≤45 s	≤39 s
	Deceleration time	≤686 s	≤330 s	≤226 s	≤162 s	≤113 s	≤82 s	≤67 s	≤54 s	≤46 s	≤36 s
<b>FA-6x50</b> (100 V)	Acceleration time	≤619 s	≤414 s	≤294 s	≤200 s	≤143 s	≤108 s	≤92 s	≤76 s	≤67 s	≤58 s
	Deceleration time	≤750 s	≤338 s	≤226 s	≤162 s	≤115 s	≤84 s	≤70 s	≤57 s	≤48 s	≤37 s
<b>FA-20x5</b> (230 V, 120 V)	Acceleration time	≤304 s	≤205 s	≤147 s	≤100 s	≤75 s	≤56 s	≤49 s	≤41 s	≤37 s	≤31 s
	Deceleration time	≤605 s	≤290 s	≤200 s	≤140 s	≤98 s	≤74 s	≤61 s	≤49 s	≤44 s	≤33 s

Rotor		0	1	2	3	4	5	6	7	8	9
<b>FA-20x5</b> (100 V)	Acceleration time	≤486 s	≤324 s	≤239 s	≤161 s	≤115 s	≤87 s	≤74 s	≤62 s	≤54 s	≤44 s
	Deceleration time	≤723 s	≤296 s	≤204 s	≤143 s	≤100 s	≤74 s	≤62 s	≤51 s	≤43 s	≤33 s
<b>FA-48x2</b> (230 V, 120 V)	Acceleration time	≤251 s	≤169 s	≤123 s	≤85 s	≤63 s	≤49 s	≤42 s	≤35 s	≤33 s	≤27 s
	Deceleration time	≤546 s	≤235 s	≤159 s	≤113 s	≤82 s	≤60 s	≤51 s	≤42 s	≤37 s	≤29 s
<b>FA-48x2</b> (100 V)	Acceleration time	≤382 s	≤249 s	≤179 s	≤124 s	≤93 s	≤69 s	≤60 s	≤51 s	≤39 s	≤37 s
	Deceleration time	≤565 s	≤226 s	≤161 s	≤117 s	≤85 s	≤62 s	≤52 s	≤43 s	≤38 s	≤29 s
<b>FA-30x2</b> (230 V, 120 V)	Acceleration time	≤245 s	≤164 s	≤120 s	≤82 s	≤62 s	≤49 s	≤42 s	≤36 s	≤31 s	≤26 s
	Deceleration time	≤359 s	≤224 s	≤155 s	≤109 s	≤79 s	≤56 s	≤48 s	≤40 s	≤34 s	≤28 s
<b>FA-30x2</b> (100 V)	Acceleration time	≤373 s	≤242 s	≤179 s	≤121 s	≤90 s	≤68 s	≤59 s	≤50 s	≤38 s	≤35 s
	Deceleration time	≤463 s	≤223 s	≤156 s	≤112 s	≤80 s	≤59 s	≤49 s	≤40 s	≤35 s	≤27 s
<b>F-48x15</b> (230 V, 120 V)	Acceleration time	≤205 s	≤137 s	≤100 s	≤68 s	≤50 s	≤39 s	≤34 s	≤29 s	≤26 s	≤23 s
	Deceleration time	≤397 s	≤196 s	≤123 s	≤87 s	≤61 s	≤45 s	≤39 s	≤33 s	≤28 s	≤23 s
<b>F-48x15</b> (100 V)	Acceleration time	≤284 s	≤190 s	≤135 s	≤92 s	≤67 s	≤53 s	≤46 s	≤38 s	≤35 s	≤30 s
	Deceleration time	≤362 s	≤185 s	≤126 s	≤89 s	≤63 s	≤48 s	≤41 s	≤34 s	≤29 s	≤24 s

## 13.8 Service life of accessories



### **CAUTION! Danger due to material fatigue.**

If the service life is exceeded, it cannot be guaranteed that the material of the rotors and the accessories will withstand the stresses during centrifugation.

- ▶ Do not use any accessories which have exceeded their maximum service life.

Eppendorf states the maximum service life of rotors and accessories in cycles and years. The number of cycles is decisive. If determination of the number of cycles is not possible, the service life in years applies.

Each centrifugation run during which the rotor is accelerated and braked is counted as a cycle, independent of the speed and the duration of the centrifugation run.

For the following rotors, the service life is based on the following standard laboratory day: Use for 25 cycles per day on 5 days a week, 52 weeks a year.


Rotor	Centrifuge	Max. service from the first commissioning onward	
		in cycles	in years
F-48x15	5910 R, 5910 Ri	100000	15
FA-6x50	5910 R, 5910 Ri, 5920 R	100000	15
FA-20x5	5910 R, 5910 Ri, 5920 R	100000	15
FA-30x2	5910 R, 5910 Ri	100000	15
FA-48x2	5910 R, 5910 Ri, 5920 R	100000	15
FA-6x250	5910 R, 5910 Ri, 5920 R	50000	7
S-4x400	5910 R, 5910 Ri	100000	15
S-4x500	5910 R, 5910 Ri	100000	15
S-4x750	5910 R, 5910 Ri, 5920 R	100000	15
S-4xUniversal	5910 R, 5910 Ri	50000	7

Unless stated otherwise (in the manual of the centrifuge, indication of the number of cycles on the rotor, in the instructions for use of the rotor), all other rotors and rotor lids can be used over the entire service life of the centrifuge if the following prerequisites are met:

- proper use
- recommended maintenance
- undamaged condition



Accessories	Max. service from the first commissioning onward
Aerosol-tight rotor lids with exchangeable seal (e.g., QuickLock rotor lids)	3 years (replace seals every 50 autoclaving cycles)
Aerosol-tight rotor lids without exchangeable seal	3 years or 50 autoclaving cycles, whichever occurs first
Non-aerosol-tight rotor lids	3 years
Aerosol-tight caps made of PP, PC, PEI	3 years or 50 autoclaving cycles, whichever occurs first
Adapter	1 year

The date of manufacture is stamped on the rotors in the format *03/15* or *03/2015* (= March 2015). On the inside of the plastic rotor lid, the date of manufacture is stamped in the form of a clock .

**To ensure aerosol tightness, the following applies:**

- ▶ Replace aerosol-tight rotor lids without exchangeable seal and cap after 50 autoclaving cycles.
- ▶ Replace the seal of aerosol-tight rotor lids with exchangeable seal (e.g., QuickLock rotor lids) after 50 autoclaving cycles.



## 14 Rotors for the Centrifuge 5910 Ri



Eppendorf centrifuges may only be operated with rotors that are intended for use with the corresponding centrifuge.




- ▶ Only use rotors that are intended for use with the corresponding centrifuge.


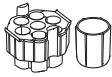

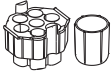

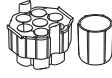

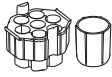
Only use rotors labeled **Centrifuge 5910 Ri**.

Please note the manufacturer's information on the centrifugation stability of the sample tubes used (maximum *g-force*).

### 14.1 Rotor S-4xUniversal


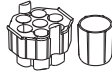
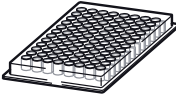
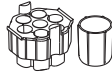

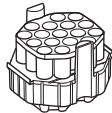

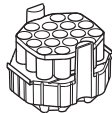

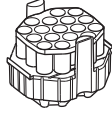

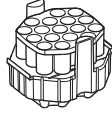

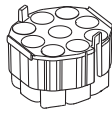
#### 14.1.1 Swing-bucket rotor S-4xUniversal with 4 universal buckets

			Max. <i>g-force</i> :	4347 × <i>g</i>
			Max. speed:	4500 rpm
<b>Rotor S-4xUniversal</b>	<b>Universal bucket and aerosol-tight cap</b>		Max. load per bucket (adapter, tube and contents):	1595 g

Vessel	Vessel Capacity Number per adapter/rotor	Adapter Order no. (international)	Bottom shape Diameter Max. tube length with/without cap	Max. <i>g-force</i> Max. speed Radius
	Conical tube 25 mL 7/28	 5910 751.001	Conical Ø 30 mm 83 mm/88 mm	3509 × <i>g</i> 4500 rpm 15.5 cm
	Conical tube 25 mL 7/28	 5910 751.001	Conical Ø 30 mm 91 mm/96 mm	3758 × <i>g</i> 4500 rpm 16.6 cm
	Conical tube 50 mL 7/28	 5910 751.001	Conical Ø 29 mm 121 mm/124 mm	4324 × <i>g</i> 4500 rpm 19.1 cm
	Conical tube 50 mL 7/28	 5910 751.001	Conical Ø 29 mm 118 mm/122 mm	4324 × <i>g</i> 4500 rpm 19.1 cm

## Rotors for the Centrifuge 5910 Ri

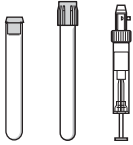
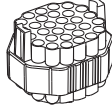

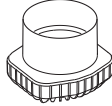

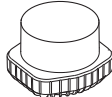
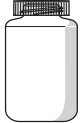

Centrifuge 5910 Ri  
English (EN)

Vessel	Vessel Capacity Number per adapter/rotor	Adapter Order no. (international)	Bottom shape Diameter Max. tube length with/without cap	Max. <i>g</i> -force Max. speed Radius
	Wide-neck bottle 250 mL  1/4	  5910 751.001	Flat Ø 62 mm  126 mm/133 mm	4234 × <i>g</i> 4500 rpm  18.7 cm
	Microplate 96/384 wells  1/4	  5910 751.001	Flat  37 mm/45 mm	2604 × <i>g</i> 4500 rpm  11.5 cm
	Eppendorf Tubes 5 mL  16/64	  5910 752.008 (without upper part)	Conical Ø 17 mm  122 mm/124 mm	4324 × <i>g</i> 4500 rpm  19.1 cm
	Conical tube 15 mL  17/64	  5910 752.008	Conical Ø 17 mm  122 mm/124 mm	4324 × <i>g</i> 4500 rpm  19.1 cm
	Microplate 96/384 wells  1/4	  5910 752.008 (without upper part)	Flat  38 mm/46 mm	3260 × <i>g</i> 4500 rpm  14.4 cm
	Deepwell plate 96 wells  1/4	  5910 752.008 (without upper part)	Flat  38 mm/46 mm	3260 × <i>g</i> 4500 rpm  14.4 cm
	Conical tube 25 mL  9/36	  5910 769.008	Conical Ø 30 mm  78.5 mm/78.5 mm	3532 × <i>g</i> 4500 rpm  15.6 cm

Vessel	Vessel Capacity Number per adapter/rotor	Adapter Order no. (international)	Bottom shape Diameter Max. tube length with/without cap	Max. g-force Max. speed Radius
	Conical tube 25 mL  9/36	  5910 769.008	Conical Ø 30 mm  91 mm/91 mm	$3781 \times g$ 4500 rpm  16.7 cm
	Conical tube 50 mL  9/36	  5910 769.008	Conical Ø 30 mm  (only load bore 2, 4, 5, 6 and 8) 116 mm/116 mm	$4347 \times g$ 4500 rpm  19.2 cm
	Conical tube 50 mL  9/36	  5910 769.008	Conical Ø 30 mm  (only load bore 2, 4, 5, 6 and 8) 118 mm/118 mm	$4347 \times g$ 4500 rpm  19.2 cm
	Microplate 96/384 wells  1/4	  5910 769.008	Flat  -16 mm	$2604 \times g$ 4500 rpm  11.5 cm
	Dished-bottom vessel 7.5 mL – 12 mL (Ø 16 × 75 mm – 100 mm) Ø 16 mm 26/104	  5910 754.000	Round Ø 16 mm  118 mm/120 mm	$4415 \times g$  4500 rpm 19.0 cm
	Vessel 9 mL (Ø 17.5 mm × 100 mm) 21/84	  5910 762.003	Round Ø 17.5 mm  118 mm/120 mm	$4256 \times g$ 4500 rpm  18.8 cm



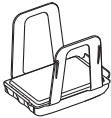
## Rotors for the Centrifuge 5910 Ri


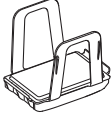
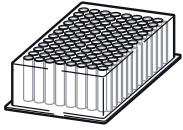
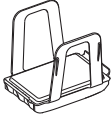
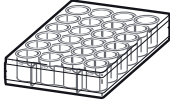
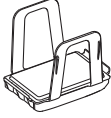
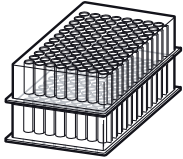
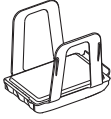
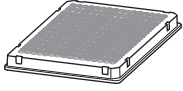
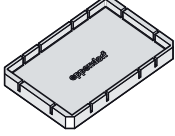
Centrifuge 5910 Ri  
English (EN)

Vessel	Vessel Capacity Number per adapter/rotor	Adapter Order no. (international)	Bottom shape Diameter Max. tube length with/without cap	Max. <i>g</i> -force Max. speed Radius
	Dished-bottom vessel 4 mL – 8 mL (Ø 13 x 75 mm – 100 mm) 30/120	 5910 755.007	Round Ø 13 mm  117 mm/119 mm	4302 × <i>g</i> 4500 rpm  19.0 cm
	Conical tube 500 mL Corning  1/4	 5910 760.000	Conical Ø 96 mm  –/148 mm	4234 × <i>g</i> 4500 rpm  18.7 cm
	Wide-neck bottle 750 mL  1/4	 5910 757.000	Flat Ø 102 mm  135 mm/139 mm	4256 × <i>g</i> 4500 rpm  18.8 cm
	Wide-neck bottle 1000 mL 1/4	 5910 756.003	Flat Ø 118 mm 133 mm/138 mm	4256 × <i>g</i> 4500 rpm 18.8 cm

### 14.1.2 Swing-bucket rotor S-4xUniversal with 4 universal buckets and a plate carrier

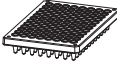
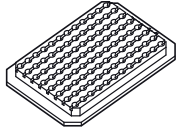


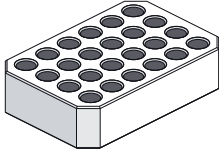

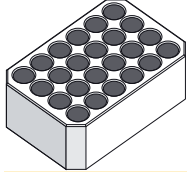
Always use the plate carrier for centrifugation of the following plates and tubes. Use a removal tool and adapter if necessary.

			Max. <i>g</i> -force: 3849 × <i>g</i>
			Max. speed: 4500 rpm
<b>Rotor S-4xUniversal</b>	<b>Universal bucket with plate carrier</b>	Max. load per bucket (adapter, tube and contents):	1 595 g

Plate/tube	Plate Capacity Number per adapter/rotor	Adapter Order no. (international)	Bottom shape Max. loading height with/without cap	Max. <i>g</i> -force Max. speed Radius
	Microplate 96/384 wells  5/20	 5910 753.004	Flat  66 mm/80 mm	3849 × <i>g</i> 4500 rpm 17.0 cm
	Deepwell plate 96 wells  1/4	 5910 753.004	Flat  66 mm/80 mm	3849 × <i>g</i> 4500 rpm 17.0 cm
	Cell-culture plate  1/4	 5910 753.004	Flat  66 mm/80 mm	3849 × <i>g</i> 4500 rpm 17.0 cm
	Kit  1/4	 5910 753.004	Flat  66 mm/80 mm	3849 × <i>g</i> 4500 rpm 17.0 cm
	PCR plate 384 wells  1/4	Plate carrier +   5825 713.001	Flat  66 mm/80 mm	3645 × <i>g</i> 4500 rpm 16.1 cm

## Rotors for the Centrifuge 5910 Ri

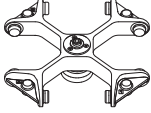


Centrifuge 5910 Ri  
English (EN)


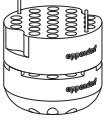

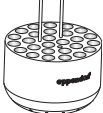
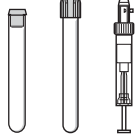
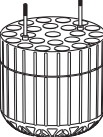


Plate/tube	Plate Capacity  Number per adapter/rotor	Adapter  Order no. (international)	Bottom shape  Max. loading height with/ without cap	Max. <i>g</i> -force Max. speed  Radius
	PCR plate 96 wells  1/4	Plate carrier +  5825 711.009	Conical  66 mm/80 mm	$3690 \times g$ 4500 rpm  16.3 cm
Slide	CombiSlide 12 slides  12/48	Plate carrier +  5825 706.005	Flat  66 mm/80 mm	$3758 \times g$ 4500 rpm  16.6 cm
	IsoRack 24 × 0.5 mL micro test tubes  1/4	Plate carrier +  5825 708.008	Open Ø 6 mm  66 mm/80 mm	$3690 \times g$ 4500 rpm  16.3 cm
	IsoRack 24 × 1.5/2 mL micro test tubes  1/4	Plate carrier +  5825 709.004	Open Ø 11 mm  66 mm/80 mm	$3600 \times g$ 4500 rpm  15.9 cm



## 14.2 Rotor S-4x750

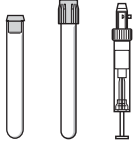
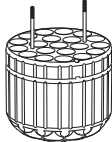

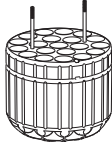



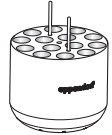

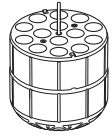


### 14.2.1 Swing-bucket rotor S-4x750 with 4 750 mL round buckets


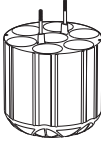

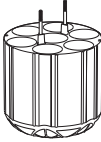

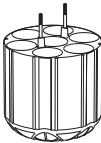

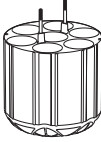

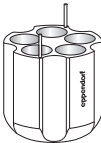
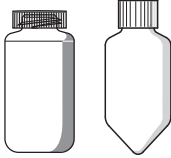

			Max. <i>g</i> -force: 120 V/230 V: 4816 × <i>g</i>
			Max. speed: 120 V/230 V: 4700 rpm
<b>Rotor S-4x750</b>	<b>Round bucket 750 mL</b>	<b>Aerosol-tight cap</b>	Max. load per bucket (adapter, tube and contents): 1000 g

Vessel	Vessel Capacity  Vessels per adapter/rotor	Adapter  Order no. (international)	Bottom shape  Tube diameter  Max. tube length with/without cap	Max. <i>g</i> -force  Max. speed  Radius
				120 V/230 V
	Micro test tube  1.5 mL/2 mL  50/200	  5825 740 009	Open  Ø 11 mm  39 mm/39 mm	Top: 3655 × <i>g</i> Bottom: 4717 × <i>g</i>  4700 rpm  Top: 14.8 cm Bottom: 19.1 cm
	Dished-bottom vessel Ø 12 mm × 75 mm  27/108	  5825 747 003	Round  Ø 12 mm  114 mm/121 mm	4594 × <i>g</i>  4700 rpm  18.6 cm
	Dished-bottom vessel 4 mL – 8 mL (Ø 13 mm × 75 mm – 100 mm)  23/92	  5825 738 004	Round  Ø 13 mm  115 mm/118 mm	4569 × <i>g</i>  4700 rpm  18.5 cm
	Eppendorf Tubes 5 mL  14/56	  5825 734 009 (without upper part)	Conical Ø 17 mm  127 mm/131 mm	4766 × <i>g</i>  4700 rpm  18.8 cm

## Rotors for the Centrifuge 5910 Ri





Centrifuge 5910 Ri  
English (EN)

Vessel	Vessel Capacity Vessels per adapter/rotor	Adapter Order no. (international)	Bottom shape Tube diameter Max. tube length with/without cap	Max. g-force
				Max. speed Radius 120 V/230 V
	Dished-bottom vessel 7.5 mL – 12 mL (Ø 16 mm x 75 mm – 100 mm) 20/80	 5825 736 001	Round Ø 16 mm 120 mm/125 mm	4668 × g 4700 rpm 18.9 cm
	Dished-bottom vessel 8 mL – 16 mL  7/28 (Load inner bores only (see p. 31))	 5825 736 001	Round Ø 16 mm  (Do not use an aerosol-tight cap)/ 125 mm	4668 × g 4700 rpm 18.9 cm
	Vessel 9 mL (Ø 17.5 mm x 100 mm) 20/80	 5825 743 008	Round Ø 17.5 mm 112 mm/117 mm	4569 × g 4700 rpm 18.5 cm
	Dished-bottom vessel 14 mL 14/56	 5825 748 000	Round Ø 17.5 mm 118 mm/123 mm	4544 × g 4700 rpm 18.4 cm
	Conical tube 15 mL 14/56	 5825 734 009	Conical Ø 17 mm x 104 mm 127 mm/131 mm	4766 × g 4700 rpm 19.3 cm
	Conical tube (skirted) 30 mL	 5825 755 006	Conical Ø 25 mm 112 mm/118 mm	4470 × g 4700 rpm 18.1 cm

Vessel	Vessel Capacity Vessels per adapter/rotor	Adapter Order no. (international)	Bottom shape Tube diameter Max. tube length with/without cap	Max. g-force
				Max. speed Radius 120 V/230 V
	Conical tube 25 mL  7/28	 5825 733 002	Conical Ø 30 mm  78.5 mm/78.5 mm	3877 × g 4700 rpm  15.7 cm
	Snap cap tube 25 mL  6/24	 5825 733 002	Conical Ø 30 mm  83 mm/83 mm	4124 × g 4700 rpm  16.7 cm
	Conical tube 50 mL  7/28	 5825 733 002	Conical Ø 30 mm  122 mm/128 mm	4766 × g 4700 rpm  19.3 cm
	Snap cap tube 50 mL  6/24	 5825 733 002	Conical Ø 30 mm  122 mm/122 mm	4766 × g 4700 rpm  19.3 cm
	Conical tube (skirted) 50 mL  5/20	 5825 732 006	Conical Ø 30 mm  122 mm/126 mm	4544 × g 4700 rpm  18.4 cm
	Wide-neck bottle/ conical tube 175 mL – 250 mL  1/4	 5825 741 005	Flat Ø 62 mm  134 mm/151 mm	4717 × g 4700 rpm  19.1 cm

## Rotors for the Centrifuge 5910 Ri

Centrifuge 5910 Ri  
English (EN)

Vessel	Vessel Capacity Vessels per adapter/rotor	Adapter Order no. (international)	Bottom shape Tube diameter Max. tube length with/without cap	Max. g-force Max. speed Radius
				120 V/230 V
	Conical tube 500 mL Corning  1/4	 5825 745 000	Conical Ø 96 mm  (Do not use an aerosol-tight cap)/ 152 mm	4766 × <i>g</i> 4700 rpm  19.3 cm
	Wide-neck bottle 750 mL 1/4	 5825 744 004	Flat Ø 102 mm -146 mm	4717 × <i>g</i> 4700 rpm 19.1 cm

### 14.2.2 Swing-bucket rotor S-4x750 with 4 plate buckets

Always use the plate carrier for centrifugation of the following plates and tubes. Use a removal tool and adapter if necessary.

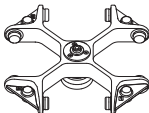


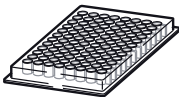

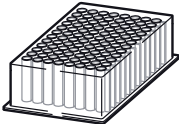

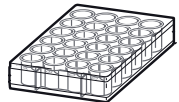

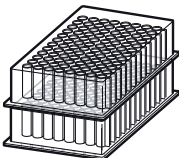


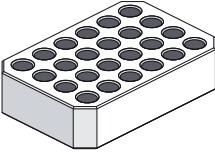

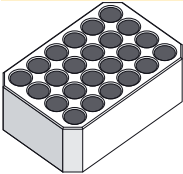
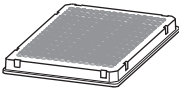
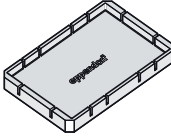
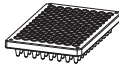
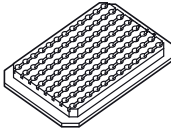
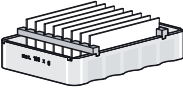
			Max. <i>g</i> -force: 120 V/230 V: 3976 × <i>g</i>
			Max. speed: 120 V/230: 4700 rpm
<b>Rotor S-4x750</b>	<b>Plate bucket</b> (always use with a plate carrier)	<b>Aerosol-tight cap</b>	Max. load per bucket (adapter, tube and contents): 450 g

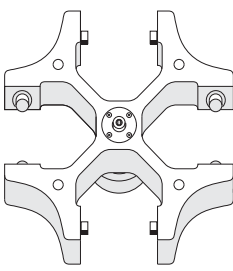

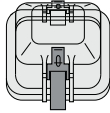
Plate	Plate Capacity Number per adapter/rotor	Adapter Order no. (international)	Bottom shape Max. loading height	Max. <i>g</i> -force
				Max. speed
				Radius
	Microplate 96/384 wells  4/16	 5820 756 004	Flat  47 mm/60 mm	120 V/230 V 3976 × <i>g</i> 4700 rpm  16.1 cm
	Deepwell plate 96 wells  1/4	 5820 756 004	Flat  47 mm/60 mm	3976 × <i>g</i> 4700 rpm  16.1 cm
	Cell-culture plate  2/8	 5820 756 004	Flat  47 mm/60 mm	3976 × <i>g</i> 4700 rpm  16.1 cm
	Kit  1/4	 5820 756 004	Flat  47 mm/60 mm	3976 × <i>g</i> 4700 rpm  16.1 cm


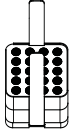

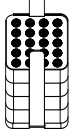

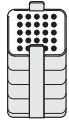
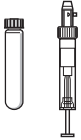

**Rotors for the Centrifuge 5910 Ri**  
Centrifuge 5910 Ri  
English (EN)

Plate	Plate Capacity Number per adapter/rotor	Adapter Order no. (international)	Bottom shape Max. loading height	Max. g-force
				Max. speed
				Radius
	IsoRack 24 × 0.5 mL micro test tubes	Plate carrier +  5825 708 008	Open Ø 6 mm  47 mm/64 mm	3803 × <i>g</i> 4700 rpm  15.4 cm
	IsoRack 24 × 1.5/2 mL micro test tubes	Plate carrier +  5825 709 004	Open Ø 11 mm  47 mm/64 mm	3704 × <i>g</i> 4700 rpm  15.0 cm
	PCR plate 384 wells	Plate carrier +  5825 713 001	Flat  47 mm/64 mm	3754 × <i>g</i> 4700 rpm  15.2 cm
	PCR plate 96 wells	Plate carrier +  5825 711 009	Conical  47 mm/64 mm	3803 × <i>g</i> 4700 rpm  15.4 cm
Slide	CombiSlide 12 slides	Plate carrier +  5825 706 005	Flat  47 mm/64 mm	3877 × <i>g</i> 4700 rpm  15.7 cm

### 14.3 Rotor S-4x500

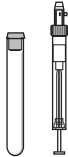
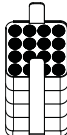
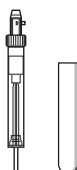
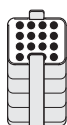

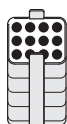



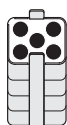



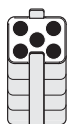
#### 14.3.1 Swing-bucket rotor S-4x500 with 4 500 mL rectangular buckets

			<table border="1"> <tr> <td>Max. <i>g</i>-force:</td> <td>3220 × <i>g</i></td> </tr> <tr> <td>Max. rotational speed:</td> <td>4000 rpm</td> </tr> </table>	Max. <i>g</i> -force:	3220 × <i>g</i>	Max. rotational speed:	4000 rpm
Max. <i>g</i> -force:	3220 × <i>g</i>						
Max. rotational speed:	4000 rpm						
<b>Rotor S-4x500</b>	<b>Rectangular bucket 500 mL</b>	<b>Aerosol-tight cap</b>	Max. load per bucket (adapter, tube and contents): 780 g				


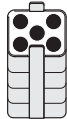



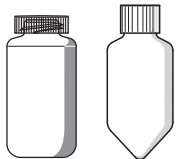


Vessel	Vessel	Adapter	Bottom shape	Max. <i>g</i> -force
	Capacity		Tube diameter	Max. speed
	Vessels per adapter/rotor	Order no. (international)	Max. tube length with/without cap	Radius
	Micro test tube 1.5/2 mL 20/80	 5810 745.004	Flat Ø 11 mm 43 mm/43 mm	2950 × <i>g</i> 4000 rpm 16.5 cm
	Blood collection tube 1.2 mL – 5 mL 20/80	 5810 746.000	Flat Ø 11 mm 108 mm/108 mm	3000 × <i>g</i> 4000 rpm 16.8 cm
	Vessel 2.6 mL – 5 mL 25/100	 5810 720.001	Flat Ø 13 mm 107 mm/108 mm	3000 × <i>g</i> 4000 rpm 16.8 cm
	Vessel 2.6 mL – 7 mL 18/72	 5810 747.007	Flat Ø 13 mm 108 mm/108 mm	3000 × <i>g</i> 4000 rpm 16.8 cm

## Rotors for the Centrifuge 5910 Ri

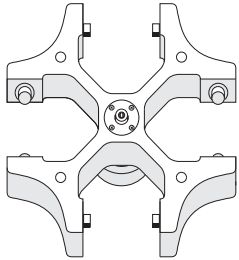
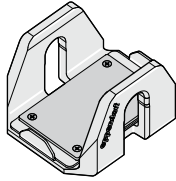
Centrifuge 5910 Ri  
English (EN)

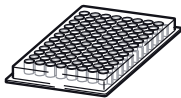
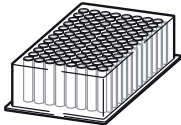
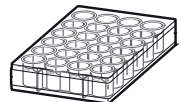
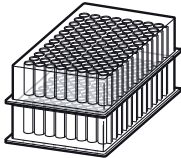

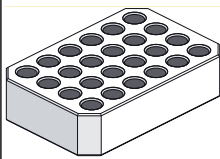
Vessel	Vessel	Adapter	Bottom shape	Max. <i>g</i> -force
	Capacity		Tube diameter	Max. speed
	Vessels per adapter/rotor	Order no. (international)	Max. tube length with/without cap	Radius
	Blood collection tube 3 mL – 15 mL 16/64	 5810 748.003	Flat Ø 16 mm 108 mm/108 mm	3000 × <i>g</i> 4000 rpm 16.8 cm
	Vessel 7 mL – 17 mL 16/64	 5810 721.008	Flat Ø 17.5 mm 118 mm/118 mm	3000 × <i>g</i> 4000 rpm 16.8 cm
	Conical tube 15 mL 12/48	 5810 722.004	Conical Ø 17.5 mm 121 mm/121 mm	3100 × <i>g</i> 4000 rpm 17.3 cm
	Conical tube 25 mL 5/20	 5810 723.000	Conical Ø 29.8 mm 78.5 mm/78.5 mm	2647 × <i>g</i> 4000 rpm 14.8 cm
	Conical tube 25 mL 5/20	 5810 723.000	Conical Ø 29.8 mm 83 mm/83 mm	2826 × <i>g</i> 4000 rpm 15.8 cm
	Conical tube 50 mL 5/20	 5810 723.000	Conical Ø 30 mm 116 mm/122 mm	3100 × <i>g</i> 4000 rpm 17.3 cm
	Conical tube 50 mL 5/20	 5810 723.000	Conical Ø 30 mm -/118 mm	3100 × <i>g</i> 4000 rpm 17.3 cm


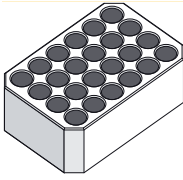
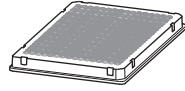
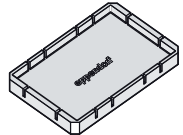
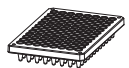
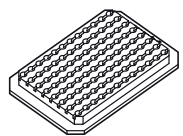
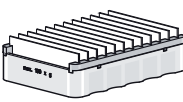

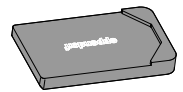


Vessel	Vessel	Adapter	Bottom shape	Max. <i>g</i> -force
	Capacity		Tube diameter	Max. speed
	Vessels per adapter/rotor	Order no. (international)	Max. tube length with/without cap	Radius
	Midi Parasep (R)  5/20	  5810 723.000	Conical Ø 30 mm 116/122 mm	3100 × <i>g</i> 4000 rpm 17.3 cm
	Conical tube, skirted 50 mL 5/20	  5810 739.004   5804 737.008	Flat  Ø 31 mm -/119 mm	3100 × <i>g</i>  4000 rpm 17.3 cm
	Bottles 180 mL – 250 mL 1/4	  5825 722.000	Flat Ø 62 mm -/133 mm	3100 × <i>g</i> 4000 rpm 17.3 cm
	Wide-neck bottle, rectangular 500 mL -/4	–	Flat  83 mm 134 mm/134 mm	3220 × <i>g</i>  4000 rpm 18.0 cm

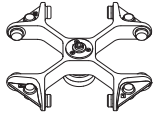


### 14.3.2 Swing-bucket rotor S-4x500 with 4 MTP/Flex buckets


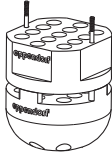


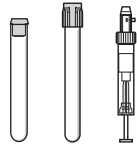
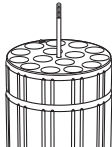
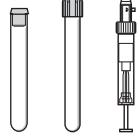
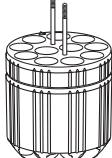
		Max. <i>g</i> -force: 2900 × <i>g</i>
		Max. rotational speed: 4000 rpm
<b>Rotor S-4x500</b>	<b>MTP/Flex buckets</b>	Max. load per bucket (adapter, tube and contents): 380 g

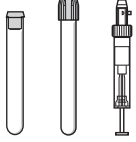
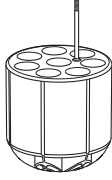

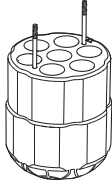

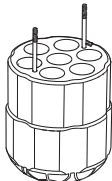

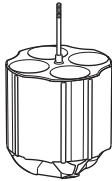

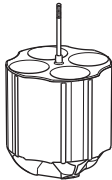
Vessel	Plate	Adapter	Bottom shape	Max. <i>g</i> -force
	Capacity		Tube diameter	Max. speed
	Number per adapter/rotor	Order no. (international)	Max. loading height	Radius
	Microplate 96/384 wells 4/16	–	Flat – 60 mm	2900 × <i>g</i> 4000 rpm 16.3 cm
	Deepwell plate 96 wells 1/4	–	Flat – 60 mm	2900 × <i>g</i> 4000 rpm 16.3 cm
	Cell-culture plate  2/8	–	Flat – 60 mm	2900 × <i>g</i> 4000 rpm 16.3 cm
	Kit  1/4	–	Flat – 60 mm	2900 × <i>g</i> 4000 rpm 16.3 cm
	IsoRack 24 × 0.5 mL micro test tubes 1/4	 5825 708.008	Flat Ø 6 mm 60 mm	2700 × <i>g</i> 4000 rpm 15.0 cm

Vessel	Plate	Adapter	Bottom shape	Max. <i>g</i> -force
	Capacity		Tube diameter	Max. speed
	Number per adapter/rotor	Order no. (international)	Max. loading height	Radius
	IsoRack 24 × 1.5/2 mL micro test tubes 1/4	 5825 709.004	Flat Ø 11 mm 60 mm	2600 × <i>g</i> 4000 rpm 14.6 cm
	PCR plate 384 wells 1/4	 5825 713.001	Flat – 60 mm	2700 × <i>g</i> 4000 rpm 15.8 cm
	PCR plate 96 wells 1/4	 5825 711.009	Flat – 60 mm	2600 × <i>g</i> 4000 rpm 16.1 cm
Slide	CombiSlide 12 slides 12/48	 5825 706.005	Flat – 60 mm	1000 × <i>g</i> 2372 rpm 15.9 cm
	Cell culture bottle with/without filter 25 cm <sup>2</sup> : Sarstedt 83.1810.002/ 83.1810 Greiner Bio-One 690175/690160 TPP 90026/90025 IWAKI 3102-025 1/4	 5825 719.000	Flat – 60 mm	1000 × <i>g</i> 2501 rpm 14.3 cm

#### 14.4 Rotor S-4x400


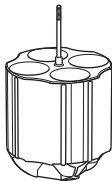

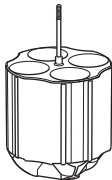

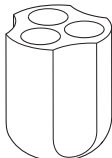






			Max. <i>g</i> -force: 5263 × <i>g</i>
			Max. speed: 5100 rpm
<b>Rotor S-4x400</b>	<b>Round bucket 400 mL</b>	<b>Aerosol-tight cap</b>	Max. load per bucket (adapter, tube and contents): 570 g

Vessel	Vessel Capacity Vessels per adapter/rotor	Adapter Order no. (international)	Bottom shape Diameter Max. tube length with/without cap	Max. <i>g</i> -force Max. speed Radius
	Micro test tube  1.5 mL/2 mL  26/104	  5910 708.009	Open  Ø 11 mm  39 mm	Top: 3897 × <i>g</i> Bottom: 5147 × <i>g</i> 5100 rpm  Top: 13.4 cm Bottom: 17.7 cm
	Dished-bottom vessel Ø 12 mm × 75 mm  17/68	  5910 711.000	Round  Ø 12 mm  112 mm/118 mm	5002 × <i>g</i>  5100 rpm  17.2 cm
	Dished-bottom vessel 4 mL – 8 mL (Ø 13 mm × 75 mm – 100 mm)  15/60	  5910 703.007	Round  Ø 13 mm  105 mm/119 mm	4973 × <i>g</i>  5100 rpm  17.1 cm
	Dished-bottom vessel 7.5 mL – 12 mL (Ø 16 mm × 75 mm – 100 mm)  11/44	  5910 704.003	Round  Ø 16 mm  115 mm/122 mm	5031 × <i>g</i>  5100 rpm  17.3 cm

Vessel	Vessel Capacity Vessels per adapter/rotor	Adapter Order no. (international)	Bottom shape Diameter Max. tube length with/without cap	Max. <i>g</i> -force Max. speed Radius
	Dished-bottom vessel 9 mL (Ø 17.5 mm × 100 mm)  8/32	  5910 709.005	Round  Ø 17.5 mm  115 mm/122 mm	5031 × <i>g</i>  5100 rpm  17.3 cm
	Eppendorf Tubes 5 mL  7/28	  5910 702.000 (without upper part)	Conical Ø 17 mm  126 mm/133 mm	5234 × <i>g</i> 5100 rpm  18.0 cm
	Conical tube 15 mL  7/28	  5910 702.000	Conical Ø 17 mm  126 mm/133 mm	5234 × <i>g</i> 5100 rpm  18.0 cm
	Conical tube 25 mL  4/16	  5910 701.004	Conical Ø 29.8 mm  78.5 mm/78.5 mm	4129 × <i>g</i> 5100 rpm  14.2 cm
	Conical tube 25 mL  4/16	  5910 701.004	Conical Ø 29.8 mm  83 mm/83 mm	4420 × <i>g</i> 5100 rpm  15.2 cm

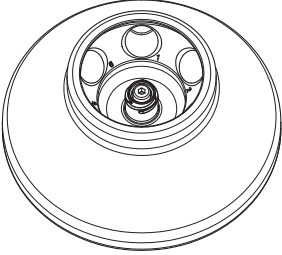
## Rotors for the Centrifuge 5910 Ri





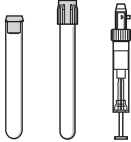



Centrifuge 5910 Ri  
English (EN)

Vessel	Vessel Capacity Vessels per adapter/rotor	Adapter Order no. (international)	Bottom shape Diameter Max. tube length with/without cap	Max. <i>g</i> -force Max. speed Radius
	Conical tube 50 mL  4/16	 5910 701.004	Conical Ø 30 mm  117 mm/125 mm	5205 × <i>g</i> 5100 rpm  17.9 cm
	Conical tube 50 mL  4/16	 5910 701.004	Conical Ø 30 mm  118 mm/123 mm	5205 × <i>g</i> 5100 rpm  17.9 cm
	Conical tube (skirted) 50 mL  3/12	 5910 712.006	Conical  Ø 29 mm  120.5 mm/122 mm	4943 × <i>g</i> 5100 rpm  17.0 cm
	Wide-neck bottle/ conical tube 175 mL – 250 mL  1/4	 5910 705.000	Flat For conical tubes, additionally use the manufacturer's adapter. Ø 62 mm  129 mm/138 mm	5060 × <i>g</i> 5100 rpm  17.4 cm
	Conical tube 175 mL – 225 mL  1/4	 5910 714.009	Conical Ø 62 mm  137 mm/143 mm	5263 × <i>g</i> 5100 rpm  18.1 cm
	Wide-neck bottle 400 mL (gray lid) 1/4	 5910 706.006	Flat Ø 62 mm  121 mm/129 mm	5030 × <i>g</i> 5100 rpm 17.3 cm

## 14.5 Rotor FA-6x50

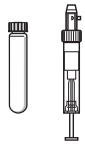

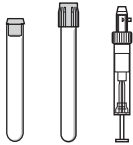








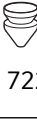


Aerosol-tight fixed-angle rotor for 6 conical tubes

	Max. <i>g</i> -force:	120 V/230 V 20130 × <i>g</i>
	Max. speed:	120 V/230 V 12100 rpm
<b>Rotor FA-6x50</b>	Max. load (adapter, tube and contents):	6 × 75 g





Vessel	Vessel Capacity Vessels per adapter/rotor	Adapter Order no. (international)	Bottom shape Tube diameter Max. tube length with rotor lid	120 V/230 V Max. <i>g</i> -force 120 V/230 V Max. speed Radius
	Dished-bottom vessel 16 mL 1/6	 5820 720 000	Round Ø 18.1 mm 107 mm	19642 × <i>g</i> 12100 rpm 12.0 cm
	Dished-bottom vessel 2.6 mL – 5 mL (Ø 13 mm × 75 mm) 1/6	 5820 726 008	Round Ø 13.5 mm –	19642 × <i>g</i> 12100 rpm 12.0 cm
	Dished-bottom vessel 4 mL – 8 mL (Ø 13 mm × 100 mm) 1/6	 5820 725 001	Round Ø 13.5 mm 119 mm	19642 × <i>g</i> 12100 rpm 12.0 cm
	Eppendorf Tubes 5 mL 1/6	 5820 730 005	Conical Ø 17 mm –	19806 × <i>g</i> 12100 rpm 12.1 cm

## Rotors for the Centrifuge 5910 Ri

Centrifuge 5910 Ri  
English (EN)

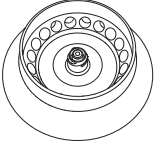
Vessel	Vessel  Capacity  Vessels per adapter/rotor	Adapter  Order no. (international)	Bottom shape  Tube diameter  Max. tube length with rotor lid	120 V/230 V Max. <i>g</i> -force  120 V/230 V Max. speed  Radius
	Dished-bottom vessel 5.5 mL – 10 mL (Ø 16 mm × 75 mm) 1/6	 5820 728 000	Round  Ø 16 mm  –	19642 × <i>g</i>  12100 rpm  12.0 cm
	Dished-bottom vessel 7.5 mL – 12 mL (Ø 16 mm × 100 mm) 1/6	 5820 727 004	Round  Ø 16.4 mm  119 mm	19642 × <i>g</i>  12100 rpm  12.0 cm
	Vessel 9 mL 1/6	 5820 729 007	Round Ø 16.4 mm 112 mm	19642 × <i>g</i> 12100 rpm 12.0 cm
	Conical tube 15 mL 1/6	 5820 717 009	Conical Ø 17 mm 125 mm	19642 × <i>g</i> 12100 rpm 12.0 cm
	Dished-bottom vessel 30 mL 1/6	 5820 721 006	Round Ø 25.7 mm 104 mm	17187 × <i>g</i> 12100 rpm 10.5 cm
	Conical tube 35 mL 1/6	 5820 722 002	Conical Ø 28.7 mm 113 mm	18333 × <i>g</i> 12100 rpm 11.2 cm
	Conical tube 25 mL 1/6	 5820 734 000	Conical Ø 29.8 mm 78.5 mm	15877 × <i>g</i> 12100 rpm 9.7 cm










Vessel	Vessel  Capacity  Vessels per adapter/rotor	Adapter  Order no. (international)	Bottom shape  Tube diameter  Max. tube length with rotor lid	120 V/230 V Max. <i>g</i> -force 120 V/230 V Max. speed  Radius
	Conical tube 25 mL 1/6	 5820 733 004	Conical Ø 29.8 mm 83 mm	17023 × <i>g</i> 12100 rpm 10.4 cm
	Conical tube 50 mL 1/6	–	Conical Ø 29.6 mm 127 mm	20133 × <i>g</i> 12100 rpm 12.3 cm
	Snap cap tube 50 mL 1/6	–	Ø 30 mm 118 mm	20133 × <i>g</i> 12100 rpm 12.3 cm

## 14.6 Rotor FA-20x5

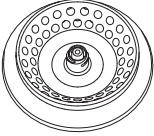
Aerosol-tight fixed-angle rotor for 20 tubes









	Max. <i>g-force</i> :	20913 × <i>g</i>
	Max. rotational speed:	13100 rpm
<b>Rotor FA-20x5</b>	Max. load (adapter, tube and contents):	20 × 9.5 g

Tube	Tube Capacity Tubes per adapter/ rotor	Adapter Order no. (international)	Bottom shape Tube diameter	Max. <i>g-force</i> Max. rotational speed Radius
	HPLC vial 1/20	 5820 770 007	Ø 11 mm	17076 × <i>g</i> 13100 rpm 8.9 cm
	Cryogenic tube 1.0 mL/2.0 mL 1/20	 5820 769 009	Ø 13 mm	18802 × <i>g</i> 13100 rpm 9.8 cm
	Micro test tube 1.5 mL/2.0 mL 1/20	 5820 768 002	Open Ø 11 mm	18227 × <i>g</i> 13100 rpm 9.5 cm
	Eppendorf Tubes 5 mL -/20		Conical Ø 17 mm	20913 × <i>g</i> 13100 rpm 10.9 cm

## 14.7 Rotor FA-48x2


Aerosol-tight fixed-angle rotor for 48 micro test tubes

	Max. <i>g</i> -force:	
	Outer ring	22132 × <i>g</i>
	Inner ring	19502 × <i>g</i>
	Max. rotational speed:	14000 rpm
<b>Rotor FA-48x2</b>	Max. load (adapter, tube and contents):	48 × 3.75 g

Tube	Tube  Capacity  Tubes per adapter/ rotor	Adapter  Order no. (international)	Bottom shape  Tube diameter	Max. <i>g</i> -force
				Outer ring
				Inner ring
				Max. rotational speed
				Radius
				Outer ring
				Inner ring
	PCR tube  0.2 mL  1/48	  5425 715.005	Conical  Ø 6 mm	17530 × <i>g</i> 14901 × <i>g</i> 14000 rpm 8 cm 6.8 cm
	Micro test tube  0.4 mL  1/48	  5425 717.008	Conical  Ø 6 mm	22132 × <i>g</i> 19502 × <i>g</i> 14000 rpm 10.1 cm 8.9 cm
	Micro test tube  0.5 mL  1/48	  5425 716.001	–  Ø 8 mm	19722 × <i>g</i> 17092 × <i>g</i> 14000 rpm 9 cm 7.8 cm
	Microtainers  0.6 mL  1/48	  5425 716.001	–  Ø 8 mm	22132 × <i>g</i> 19502 × <i>g</i> 14000 rpm 10.1 cm 8.9 cm

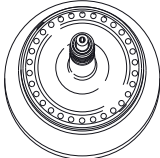
## Rotors for the Centrifuge 5910 Ri










Centrifuge 5910 Ri  
English (EN)

Tube	Tube  Capacity  Tubes per adapter/ rotor	Adapter  Order no. (international)	Bottom shape  Tube diameter	Max. <i>g</i> -force Outer ring Inner ring
				Max. rotational speed
				Radius Outer ring Inner ring
	Micro test tube  1.5 mL/2 mL  -/48		Round  Ø 11 mm	22 132 × <i>g</i> 19 502 × <i>g</i>  14 000 rpm  10.1 cm 8.9 cm

## 14.8 Rotor FA-30x2

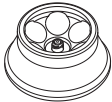
Aerosol-tight fixed-angle rotor for 30 micro test tubes


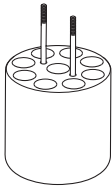
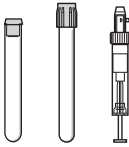
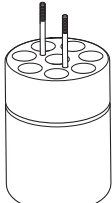
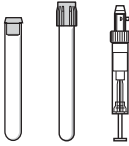
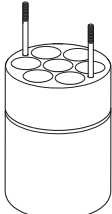
	Max. <i>g</i> -force:	20984 × <i>g</i>
	Max. rotational speed:	13700 rpm
<b>Rotor FA-30x2</b>	Max. load (adapter, tube and contents):	30 × 3.5 g


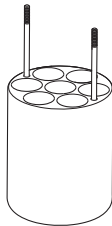

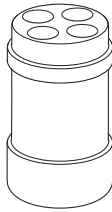

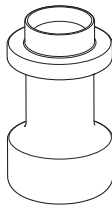

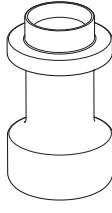

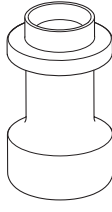
Tube	Tube Capacity  Tubes per adapter/ rotor	Adapter  Order no. (international)	Bottom shape Tube diameter	Max. <i>g</i> -force Max. rotational speed  Radius
	Micro test tube 1.5/2 mL –/30	–	– Ø 11 mm	20984 × <i>g</i> 13700 rpm 10.0 cm
	PCR tube 0.2 mL 1/30	 5425 715.005	Conical Ø 6 mm	15948 × <i>g</i> 13700 rpm 7.6 cm
	Micro test tube 0.4 mL 1/30	 5425 717.008	Conical Ø 6 mm	20817 × <i>g</i> 13700 rpm 9.7 cm
	Micro test tube 0.5 mL 1/30	 5425 716.001	Open Ø 8 mm	18400 × <i>g</i> 13700 rpm 8.6 cm
	Microtainers 0.6 mL 1/30	 5425 716.001	Open Ø 8 mm	20817 × <i>g</i> 13700 rpm 9.7 cm

## 14.9 Rotor FA-6x250

Required software version 1.5


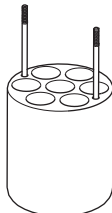

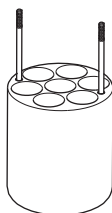

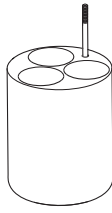

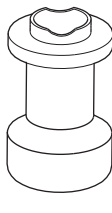

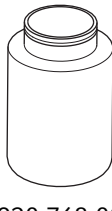
	Max. <i>g</i> -force:	120 V/230 V 15050 × <i>g</i>
	Max. speed:	120 V/230 V 10100 rpm
<b>FA-6x250</b>	Max. load per bucket (adapter, tube and contents):	6 × 365 g

Vessel	Vessel Capacity Number per adapter/rotor	Adapter Order no. (international)	Bottom shape Tube diameter Max. tube length	120 V/230 V Max. <i>g</i> -force 120 V/230 V Max. speed Radius
	Dished-bottom vessel Ø 12 mm × 75 mm  9/54	  5920 765 000	Round Ø 12 mm 114 mm	14370 × <i>g</i>  10100 rpm  12.6 cm
	Dished-bottom vessel 4 mL – 8 mL (Ø 13 × 75 mm – 100 mm)  8/48	  5920 763 008	Round Ø 13 mm 114 mm	14256 × <i>g</i>  10100 rpm  12.5 cm
	Dished-bottom vessel 7.5 mL – 12 mL (Ø 16 × 75 mm – 100 mm)  7/42	  5920 762 001	Round Ø 16 mm 115 mm	14256 × <i>g</i>  10100 rpm  12.5 cm

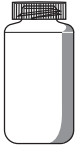
<b>Vessel</b>	<b>Vessel</b>  <b>Capacity</b>  <b>Number per adapter/rotor</b>	<b>Adapter</b>  <b>Order no. (international)</b>	<b>Bottom shape</b>  <b>Tube diameter</b>  <b>Max. tube length</b>	<b>120 V/230 V</b> <b>Max. g-force</b> <b>120 V/230 V</b> <b>Max. speed</b> <b>Radius</b>
	Vessel 9 mL (Ø 17.5 mm × 100 mm)  7/42	 5920 764 004	Round Ø 17.5 mm  112 mm	14370 × g 10100 rpm  12.6 cm
	Conical tube 15 mL  4/24	 5920 761 005	Conical Ø 17 mm  122 mm	13686 × g 10100 rpm  12 cm
	Conical tube 50 mL  1/6	 5920 760 009	Conical Ø 30 mm  125 mm	12545 × g 10100 rpm  11 cm
	Snap cap tube 50 mL  1/6	 5920 760 009	Conical Ø 30 mm  125 mm	12545 × g 10100 rpm  11 cm
	Conical tube (skirted) 50 mL  1/6	 5920 766 007	Conical, skirted Ø 30 mm  125 mm	12317 × g 10100 rpm  10.8 cm

## Rotors for the Centrifuge 5910 Ri

Centrifuge 5910 Ri  
English (EN)

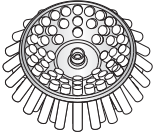
Vessel	Vessel Capacity Number per adapter/rotor	Adapter Order no. (international)	Bottom shape Tube diameter Max. tube length	120 V/230 V Max. <i>g</i> -force 120 V/230 V Max. speed Radius
	Dished-bottom vessel 10 mL  7/42	 5920 769 006	Round Ø 17 mm  115 mm	14370 × <i>g</i>  10100 rpm  12.6 cm
	Dished-bottom vessel 16 mL  7/42	 5920 770 004	Round Ø 18 mm  115 mm	14370 × <i>g</i>  10100 rpm  12.6 cm
	Dished-bottom vessel 30 mL  3/18	 5920 767 003	Round Ø 26 mm  116 mm	14256 × <i>g</i>  10100 rpm  12.5 cm
	Dished-bottom vessel 50 mL  1/6	 5920 771 000	Round Ø 29 mm  125 mm	12659 × <i>g</i>  10100 rpm  11.1 cm
	Dished-bottom vessel 85 mL  1/6	 5920 768 000	Round Ø 38 mm  118 mm	12887 × <i>g</i>  10100 rpm  11.3 cm

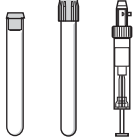





Vessel	Vessel Capacity Number per adapter/rotor	Adapter Order no. (international)	Bottom shape Tube diameter Max. tube length	120 V/230 V Max. g-force 120 V/230 V Max. speed Radius
	Wide-neck bottle 250 mL flat 6		Flat Ø 62 mm 135 mm	15054 × g 10100 rpm 13.2 cm

### 14.10 Rotor F-48x15

Fixed-angle rotor with 48 steel cores

	Max. g-force	5005 × g
	Max. rotational speed	5500 rpm
<b>Rotor F-48x15</b>	Max. load (sleeve, adapter, tube and contents)	48 × 56 g

Tube	Tube Capacity Tubes per adapter/ rotor	Adapter	Bottom shape Tube diameter Max. tube length	Max. g-force Max. speed Radius
	Tube 7.5 to 12 mL 1/48	 5702701.009	Flat Ø 16 mm 127 mm	5005 × g 5500 rpm 14.8 cm
	Conical tube 15 mL 1/40	 5702708.003	Conical Ø 17 mm 127 mm	5005 × g 5500 rpm 14.8 cm



## 15 Ordering Information

### 15.1 Rotors and accessories

The order numbers for the adapters can be found in the "Rotors for Centrifuge 5910 R" chapter (see p. 95).

#### 15.1.1 Rotor S-4xUniversal

Order no. (International)	Description
5895 200.001	<b>Rotor S-4xUniversal</b> incl. universal buckets

#### 15.1.2 Rotor S-4x750

Order no. (International)	Description
5895 120.008	<b>Rotor S-4x750</b> incl. round bucket
5895 123.007 5895 122.000	<b>Round bucket S-4x750</b> 2 pieces 4 pieces
5820 747.005	<b>Aerosol-tight cap</b> Rotors S-4-104, S-4x750, S-4x1000, round bucket 750 mL/1000 mL 2 pieces
5820 749.008	<b>Sealings for aerosol-tight caps</b> Rotors S-4-104, S-4x750, S-4x1000, round bucket 750 mL/1000 mL 5 pieces
5920 754.009	<b>Sealings for aerosol-tight caps</b> Rotor S-4xUniversal-Large, rotor S-4xuniversal, universal buckets 5 pieces

Order no. (International)	Description
5895 128.009	<b>Rotor S-4x750</b> incl. plate bucket
5895 125.000 5895 124.003	<b>Plate bucket (aerosol-tight capable)</b> for Rotor S-4x750 2 pieces 4 pieces
5820 748.001	<b>Aerosol-tight cap</b> Rotors S-4-104, S-4x750, Plate Bucket 2 pieces
5820 780.002	<b>Sealings for aerosol-tight caps</b> Rotors S-4-104, S-4x750, S-4x1000, Plate/Tube Bucket 4 pieces

**Ordering Information**Centrifuge 5910 Ri  
English (EN)

Order no. (International)	Description
5820 756.004	<b>Plate carrier</b> Rotor S-4-104, S-4x750 2 pieces

**15.1.3 Rotor S-4x500**

Order no. (International)	Description
5895 170.005 5895 171.001	<b>Rotor S-4x500</b> for 500 mL rectangular buckets or MTP/Flex-buckets incl. 4 × 500 mL rectangular buckets without bucket
5810 730.007	<b>Rectangular bucket 500 mL</b> Set of 4
5810 742.005 5810 741.009	<b>MTP/Flex buckets</b> for use with IsoRack and cell culture flask adapters as well as MTP and DWP 2 pieces 4 pieces

**15.1.4 Rotor S-4x400**

Order no. (International)	Description
5895 180.000 5895 181.007	<b>Rotor S-4x400</b> incl. round bucket 400 mL without bucket
5895 183.000 5895 182.003	<b>Round bucket S-4x400</b> 2 pieces 4 pieces
5910 700.008	<b>Aerosol-tight cap</b> Rotor S-4x400, round buckets 400 mL 2 pieces
5910 710.003	<b>Sealings for aerosol-tight caps</b> Rotor S-4x400, round buckets 400 mL 2 pieces

### 15.1.5 Rotor FA-6x50

Order no. (International)	Description
5895 150.004	<b>Rotor FA-6x50</b> aerosol-tight, 6 × 50 mL conical tubes incl. aerosol-tight rotor lid
5895 151.000	<b>Rotor lid FA-6x50</b> aerosol-tight, aluminum
5418 709.008	<b>Seal for rotor lid</b> FA-45-18-11 (5418/5418 R), FA-45-6-30 (5804/5804 R/5810/5810 R), FA-6x50 (5910 R, 5920 R, 5910 Ri) 5 pieces

### 15.1.6 Rotor FA-20x5

Order no. (International)	Description
5895 130.003	<b>Rotor FA-20x5</b> aerosol-tight, 20 × 5 mL tubes incl. aerosol-tight rotor lid
5895 131.000	<b>Rotor lid FA-20x5</b> aerosol-tight, aluminum
5409 718.002	<b>Seal for rotor lid</b> FA-45-20-17 (5804/5804 R/5810/5810 R), FA-20x5 (5910 R, 5920 R, 5910 Ri) 5 pieces

### 15.1.7 Rotor FA-48x2

Order no. (International)	Description
5895 135.005	<b>Rotor FA-48x2</b> aerosol-tight, 48 × 1,5/2 mL tubes incl. aerosol-tight rotor lid
5895 136.001	<b>Rotor lid FA-48x2</b> aerosol-tight, aluminum
5820 767.006	<b>Seal for rotor lid</b> FA-45-24-11-Kit (5427 R/530/5430 R), FA-45-48-11 (5427 R/5430/5430 R, 5804/5804 R/5810/5810 R), FA-30x2 (5910 R, 5920 R, 5910 Ri), FA-48x2 (5910 R, 5920 R, 5910 Ri) 5 pieces

**Ordering Information**Centrifuge 5910 Ri  
English (EN)**15.1.8 Rotor FA-30x2**

Order no. (International)	Description
5895 155.006	<b>Rotor FA-30x2</b> aerosol-tight, 30 × 1,5/2 mL tubes incl. aerosol-tight rotor lid
5895 156.002	<b>Rotor lid FA-30x2</b> aerosol-tight, aluminum
5820 767.006	<b>Seal for rotor lid</b> FA-45-24-11-Kit (5427 R/530/5430 R), FA-45-48-11 (5427 R/5430/5430 R, 5804/ 5804 R/5810/5810 R), FA-30x2 (5910 R, 5920 R, 5910 Ri), FA-48x2 (5910 R, 5920 R, 5910 Ri) 5 pieces

**15.1.9 Rotor F-48x15**

Order no. (International)	Description
5895 160.000	<b>Rotor F-48x15</b> for 48 × 15 mL conical tubes incl. 48 steel sleeves and adapters
5820 774.002	<b>Steel sleeves and adapter</b> for vessels 15 mL for rotors F-35-48-17 (5804/5804 R/5810/5810 R) , F-48x15 (5910 R) (5804/5804 R/ 5810/5810 R) , F-48x15 (5910 R)

**15.1.10 Rotor FA-6x250**

Order no. (International)	Description
5895 175.007	<b>FA-6x250 rotor</b> for 6 x 250 mL tubes, incl. QuickLock rotor cover, aerosol-tight, Centrifuge 5910 R/ 5910 Ri/5920 R
5895 176.003	<b>QuickLock rotor cover</b> aerosol-tight, replacement part for FA-6x250 rotor
5895 177.000	<b>Seal for rotor lid</b> 5 pieces

## 15.2 Accessories

Order no. (International)	Description
0113 005.106	<b>Rotor key</b>
0113 204.486	<b>Mains/power cord</b> 230 V/50 Hz, Europe
0113 204.680	230 V/50 Hz, GB/HK
0013 613.953	230 V/50 Hz, CN
0113 204.699	230 V/50 Hz, AUS
0113 205.105	230 V/50 Hz, ARG
5810 350.050	<b>Pivot grease</b> Tube 20 mL

**Ordering Information**

Centrifuge 5910 Ri  
English (EN)



# Declaration of Conformity

The product named below fulfills the requirements of directives and standards listed. In the case of unauthorized modifications to the product or an unintended use this declaration becomes invalid. This declaration of conformity is issued under the sole responsibility of the manufacturer.

**Product name:**

Centrifuge 5910 Ri  
including components

**Product type:**

Centrifuge

**Relevant directives / standards:**

2017/746/EU: DIN EN ISO 13485, DIN EN ISO 18113-1, DIN EN ISO 18113-3, DIN EN ISO 15223-1, DIN EN ISO 14971, DIN EN 61010-2-101, DIN EN 61326-2-6, DIN EN 62366-1

2014/35/EU: DIN EN 61010-1, DIN EN 61010-2-020

2014/30/EU: DIN EN 61326-1, DIN EN 55011

2011/65/EU: DIN EN IEC 63000  
(incl. (EU) 2015/863)

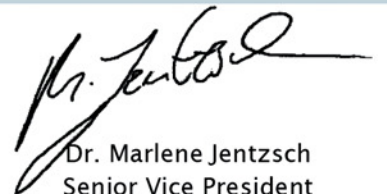
Further applied standards: IEC 61010-1 + Cor. + A1 + A1/Cor.1, IEC 61010-2-020, IEC 61010-2-101  
UL 61010-1, UL 61010-2-020  
CAN/CSA C22.2 No. 61010-1-12, CAN/CSA C22.2 No. 61010-2-020  
IEC 61326-1, CISPR 11 + A1, 47 CFR FCC part 15  
YY/T 0657, GB 4793.1, GB 4793.7, GB 18268.1, YY/T 0466.1, SJ/T 11364, GB/T 26572

Basic UDI-DI: 04043758-IA-CEN-002-NT

Hamburg, November 10, 2021



Dr. Wilhelm Plüster  
Management Board



Dr. Marlene Jentzsch  
Senior Vice President  
Division Separation & Instrumentation

Your local distributor: [www.eppendorf.com/contact](http://www.eppendorf.com/contact)  
Eppendorf SE · Barkhausenweg 1 · 22339 Hamburg · Germany  
[eppendorf@eppendorf.com](mailto:eppendorf@eppendorf.com)

Eppendorf® and the Eppendorf Brand Design are registered trademarks of Eppendorf SE, Germany.  
All rights reserved, incl. graphics and pictures. Copyright ©2021 by Eppendorf SE.

ISO  
9001  
Certified

ISO 13485  
Certified

ISO 14001  
Certified

# CERTIFICATE OF COMPLIANCE

**Certificate Number** 2021-02-09-E215059  
**Report Reference** E215059-D1025-1/A0/C0-UL  
**Date** 2021-02-09

**Issued to:** EPPENDORF AG  
**Applicant Company:** BARKHAUSENWEG 1  
HAMBURG, 22339 GERMANY

**Listed Company:** Same as Applicant

**This is to certify that representative samples of** Laboratory Centrifuge  
5910 Ri (5943)

Have been investigated by UL in accordance with the Standard(s) indicated on this Certificate.

**Standard(s) for Safety:** UL 61010-1, 3rd Edition, May 11, 2012, Revised April 29 2016,  
CAN/CSA-C22.2 No. 61010-1-12, 3rd Edition, Revision dated April 29 2016

**Additional Standards:** UL 61010-1, 3rd Edition, May 11, 2012, Revised April 29 2016,  
CAN/CSA-C22.2 No. 61010-1-12, 3rd Edition, Revision dated April 29 2016,  
IEC 61010-1:2010 (Third Edition)

IEC 61010-2-020:2016  
CAN/CSA-C22.2 NO. 61010-2-020:2017  
UL 61010-2-020 (Third Edition, issue date 2016-12-15).

IEC 61010-2-011:2016  
CSA C22.2 NO. 61010-2-011:17  
ANSI/UL 61010-2-011:2017

IEC 61010-2-101:2015  
CAN/CSA C22.2 No. 61010-2-101:15  
ANSI/UL 61010-2-101:2015



Bruce Mahrenholz, Director North American Certification Program

UL LLC

Any information and documentation involving UL Mark services are provided on behalf of UL LLC (UL) or any authorized licensee of UL. For questions, please contact a local UL Customer Service Representative at <http://ul.com/about/locations/>







# Certificate of Containment Testing

## Containment Testing of Caps (5820 741.309-00) for Rotor S- 4x750 with Roundbuckets (5895 102.115-00) in the Eppendorf 5920/R Bench Top Centrifuge

Report No. 14/014

**Report Prepared For:** Eppendorf AG, Hamburg, Germany

**Issue Date:** 26<sup>th</sup> June 2014

### Test Summary

Caps (5820 741.309-00) for rotor S-4x750 with Roundbuckets (5895 102.115-00) were containment tested in the Eppendorf 5920/R bench top centrifuge, using Annex AA of IEC 61010-2-020:2006 (2<sup>nd</sup> Ed.). The sealed rotor was shown to contain a spill within the centrifuge.

#### Report Written By

**Name:** Mr Matthew Hewitt

**Title:** Biosafety Scientist

#### Report Authorised By

**Name:** Mrs Sara Speight

**Title:** Senior Biosafety Scientist



Public Health  
England

Public Health England  
Microbiology Services  
Porton Down  
Salisbury  
Wiltshire  
SP4 OJG

# Certificate of Containment Testing

## Containment Testing of Rotor S-4x750 (5895 120.105-00) with Plate Buckets (5895 124.119-00\*) and Caps (5895 104.304-00<sup>#</sup>) in an Eppendorf Bench Top Centrifuge

Report No. 14/043 B

**Report Prepared For:** Eppendorf AG, Hamburg, Germany

**Issue Date:** 17<sup>th</sup> February 2015

### Test Summary

Rotor S-4x750 (5895 120.105-00) with Plate Buckets (5895 124.119-00\*) and Caps (5895 104.304-00<sup>#</sup>) was containment tested in an Eppendorf bench top centrifuge, using Annex AA of IEC 61010-2-020:2006 (2<sup>nd</sup> Ed.). The sealed buckets were shown to contain a spill.

#### Report Written By

**Name:** Ms Anna Moy

**Title:** Biosafety Scientist

#### Report Authorised By

**Name:** Mrs Sara Speight

**Title:** Senior Biosafety Scientist

Please be aware that the use of the Royal Coat of Arms is highly restricted and cannot be copied. Please do not put the PHE logo on your website or use our name to endorse your products. Any reference to PHE needs to be approved by us before it can be used.

\* Part no. will form part of catalogue number 5895 128.009; 5895 124.003; 5895 125.000

# Part no. will form part of catalogue number 5895 111.009





Public Health  
England

Public Health England  
Microbiology Services  
Porton Down  
Salisbury  
Wiltshire  
SP4 OJG

# Certificate of Containment Testing

## Containment Testing of Rotor S-4x750 (5895 120.105-00) with Plate Buckets (5895 124.119-00\*) and Caps (5820 743.301-00<sup>#</sup>) in an Eppendorf Bench Top Centrifuge

Report No. 14/043 A

**Report Prepared For:** Eppendorf AG, Hamburg, Germany

**Issue Date:** 17<sup>th</sup> February 2015

### Test Summary

Rotor S-4x750 (5895 120.105-00) with Plate Buckets (5895 124.119-00\*) and Caps (5820 743.301-00<sup>#</sup>) was containment tested in an Eppendorf bench top centrifuge, using Annex AA of IEC 61010-2-020:2006 (2<sup>nd</sup> Ed.). The sealed buckets were shown to contain a spill.

#### Report Written By

**Name:** Ms Anna Moy

**Title:** Biosafety Scientist

#### Report Authorised By

**Name:** Mrs Sara Speight

**Title:** Senior Biosafety Scientist

Please be aware that the use of the Royal Coat of Arms is highly restricted and cannot be copied. Please do not put the PHE logo on your website or use our name to endorse your products. Any reference to PHE needs to be approved by us before it can be used.

\* Part no. will form part of catalogue number 5895 128.009; 5895 124.003; 5895 125.000

# Part no. will form part of catalogue number 5820 748.001





Public Health  
England

Public Health England  
Microbiology Services  
Porton Down  
Salisbury  
Wiltshire  
SP4 OJG

# Certificate of Containment Testing

## Containment Testing of Rotor S-4x400 (5895 180.108-00) with Roundbucket (5895 182.119-00\*) and Caps (5910 700.105-00<sup>#</sup>) in an Eppendorf Bench Top Centrifuge

Report No. 17/006 A

**Report Prepared For:** Eppendorf AG, Hamburg, Germany

**Issue Date:** 28 June 2017

### Test Summary

Rotor S-4x400 (5895 180.108-00) with Roundbucket (5895 182.119-00\*) and Caps (5910 700.105-00<sup>#</sup>) was containment tested in an Eppendorf bench top centrifuge, using Annex AA of IEC 61010-2-020:2016 (3<sup>rd</sup> Ed.). The sealed buckets were shown to contain a spill.

Report Written By

**Name:** Ms Anna Moy

**Title:** Biosafety Scientist

Report Authorised By

**Name:** Mrs Sara Speight

**Title:** Senior Biosafety Scientist

Please be aware that the use of the Royal Coat of Arms is highly restricted and cannot be copied. Please do not put the PHE logo on your website or use our name to endorse your products. Any reference to PHE needs to be approved by us before it can be used.

\* Part no. will form part of catalogue number 5895 180.000; 5895 182.003; 5895 183.000

# Part no. will form part of catalogue number 5910 700.008



# Certificate of Containment Testing

## Containment Testing of Rotor FA-6x50 (5895 150.101-00\*) in an Eppendorf Bench Top Centrifuge

Report No. 14/029 A

**Report Prepared For:** Eppendorf AG, Hamburg, Germany

**Issue Date:** 17<sup>th</sup> February 2015

### Test Summary

Rotor FA-6x50 (5895 150.101-00\*) was containment tested in an Eppendorf bench top centrifuge, using Annex AA of IEC 61010-2-020:2006 (2<sup>nd</sup> Ed.). The sealed rotor was shown to contain a spill.

**Report Written By**

**Name:** Ms Anna Moy

**Title:** Biosafety Scientist

**Report Authorised By**

**Name:** Mrs Sara Speight

**Title:** Senior Biosafety Scientist

Please be aware that the use of the Royal Coat of Arms is highly restricted and cannot be copied. Please do not put the PHE logo on your website or use our name to endorse your products. Any reference to PHE needs to be approved by us before it can be used.





Public Health  
England

Public Health England  
Microbiology Services  
Porton Down  
Salisbury  
Wiltshire  
SP4 OJG

# Certificate of Containment Testing

## Containment Testing of Rotor FA-20x5 (5895 130.100-00\*) in an Eppendorf Bench Top Centrifuge

Report No. 14/029 B

**Report Prepared For:** Eppendorf AG, Hamburg, Germany

**Issue Date:** 17<sup>th</sup> February 2015

### Test Summary

Rotor FA-20x5 (5895 130.100-00\*) was containment tested in an Eppendorf bench top centrifuge, using Annex AA of IEC 61010-2-020:2006 (2<sup>nd</sup> Ed.). The sealed rotor was shown to contain a spill.

**Report Written By**

**Name:** Ms Anna Moy

**Title:** Biosafety Scientist

**Report Authorised By**

**Name:** Mrs Sara Speight

**Title:** Senior Biosafety Scientist

Please be aware that the use of the Royal Coat of Arms is highly restricted and cannot be copied. Please do not put the PHE logo on your website or use our name to endorse your products. Any reference to PHE needs to be approved by us before it can be used.





Public Health  
England

Public Health England  
Microbiology Services  
Porton Down  
Salisbury  
Wiltshire  
SP4 OJG

# Certificate of Containment Testing

## Containment Testing of Rotor FA-48x2 (5895 135.102-00\*) in an Eppendorf Bench Top Centrifuge

Report No. 14/029 C

**Report Prepared For:** Eppendorf AG, Hamburg, Germany

**Issue Date:** 17<sup>th</sup> February 2015

### Test Summary

Rotor FA-48x2 (5895 135.102-00\*) was containment tested in an Eppendorf bench top centrifuge, using Annex AA of IEC 61010-2-020:2006 (2<sup>nd</sup> Ed.). The sealed rotor was shown to contain a spill.

**Report Written By**

**Name:** Ms Anna Moy

**Title:** Biosafety Scientist

**Report Authorised By**

**Name:** Mrs Sara Speight

**Title:** Senior Biosafety Scientist

Please be aware that the use of the Royal Coat of Arms is highly restricted and cannot be copied. Please do not put the PHE logo on your website or use our name to endorse your products. Any reference to PHE needs to be approved by us before it can be used.



# Certificate of Containment Testing

## Containment Testing of Rotor FA-30x2 (5895 155.103-00\*) in an Eppendorf Bench Top Centrifuge

Report No. 14/029 D

**Report Prepared For:** Eppendorf AG, Hamburg, Germany

**Issue Date:** 17<sup>th</sup> February 2015

### Test Summary

Rotor FA-30x2 (5895 155.103-00\*) was containment tested in an Eppendorf bench top centrifuge, using Annex AA of IEC 61010-2-020:2006 (2<sup>nd</sup> Ed.). The sealed rotor was shown to contain a spill.

**Report Written By**

**Name:** Ms Anna Moy

**Title:** Biosafety Scientist

**Report Authorised By**

**Name:** Mrs Sara Speight

**Title:** Senior Biosafety Scientist

Please be aware that the use of the Royal Coat of Arms is highly restricted and cannot be copied. Please do not put the PHE logo on your website or use our name to endorse your products. Any reference to PHE needs to be approved by us before it can be used.





# Certificate of Containment Testing

## Containment Testing of Rotor FA-6x250 (5895 175.104-00\*) with Lid (5895 175.309-00<sup>#</sup>) in an Eppendorf Bench Top Centrifuge

Report No. 18/030 B

**Report Prepared For:** Eppendorf AG, Hamburg, Germany

**Issue Date:** 24 January 2019

### Test Summary

Rotor FA-6x250 was containment tested in an Eppendorf bench top centrifuge, using Annex AA of IEC 61010-2-020:2016 (3<sup>rd</sup> Ed.). The sealed rotor was designed to prevent any spill reaching the rotor lid and therefore preventing migration of spores across the seal.

#### Report Written By

**Name:** Ms Anna Moy

**Title:** Biosafety Scientist

#### Report Authorised By

**Name:** Mrs Sara Speight

**Title:** Senior Biosafety Scientist

Please be aware that the use of the Royal Coat of Arms is highly restricted and cannot be copied. Please do not put the PHE logo on your website or use our name to endorse your products. Any reference to PHE needs to be approved by us before it can be used.

\* Part no. will form part of catalogue number 5895 175.007

# Part no. will form part of catalogue number 5895 176.003



# Certificate of Containment Testing

## Containment Testing of Rotor S-4x500 (5895 170.102-00) with Rectangle Buckets (5810 719.119-02\*) and Caps (5810 724.104-00<sup>#</sup>) in an Eppendorf Bench Top Centrifuge

Report No. 17/006 B

**Report Prepared For:** Eppendorf AG, Hamburg, Germany

**Issue Date:** 18 September 2017

### Test Summary

Rotor S-4x500 (5895 170.102-00) with Rectangle Buckets (5810 719.119-02\*) and Caps (5810 724.104-00<sup>#</sup>) was containment tested in an Eppendorf bench top centrifuge, using Annex AA of IEC 61010-2-020:2016 (3<sup>rd</sup> Ed.). The sealed buckets were shown to contain a spill.

Report Written By

**Name:** Ms Anna Moy

**Title:** Biosafety Scientist

Report Authorised By

**Name:** Mrs Sara Speight

**Title:** Senior Biosafety Scientist

Please be aware that the use of the Royal Coat of Arms is highly restricted and cannot be copied. Please do not put the PHE logo on your website or use our name to endorse your products. Any reference to PHE needs to be approved by us before it can be used.

\* Part no. will form part of catalogue number 5895 170.005; 5810 730.007

# Part no. will form part of catalogue number 5810 742.007





Public Health  
England

Public Health England  
Microbiology Services  
Porton Down  
Salisbury  
Wiltshire  
SP4 OJG

# Certificate of Containment Testing

## Containment Testing of Rotor S-4x400 (5895 180.108-00) with Roundbucket (5895 182.119-00\*) and Caps (5910 700.105-00<sup>#</sup>) in an Eppendorf Bench Top Centrifuge

Report No. 17/006 A

**Report Prepared For:** Eppendorf AG, Hamburg, Germany

**Issue Date:** 28 June 2017

### Test Summary

Rotor S-4x400 (5895 180.108-00) with Roundbucket (5895 182.119-00\*) and Caps (5910 700.105-00<sup>#</sup>) was containment tested in an Eppendorf bench top centrifuge, using Annex AA of IEC 61010-2-020:2016 (3<sup>rd</sup> Ed.). The sealed buckets were shown to contain a spill.

Report Written By

**Name:** Ms Anna Moy

**Title:** Biosafety Scientist

Report Authorised By

**Name:** Mrs Sara Speight

**Title:** Senior Biosafety Scientist

Please be aware that the use of the Royal Coat of Arms is highly restricted and cannot be copied. Please do not put the PHE logo on your website or use our name to endorse your products. Any reference to PHE needs to be approved by us before it can be used.

\* Part no. will form part of catalogue number 5895 180.000; 5895 182.003; 5895 183.000

# Part no. will form part of catalogue number 5910 700.008



# Certificate of Containment Testing

## Containment Testing of Rotor S-4xuniversal (5895 200.109-00) with Universal Buckets (5895 202.101-00\*) and Caps (5910 750.120-00<sup>#</sup>) in an Eppendorf Bench Top Centrifuge

Report No. 17/006 C

**Report Prepared For:** Eppendorf AG, Hamburg, Germany

**Issue Date:** 18 September 2017

### Test Summary

Rotor S-4xuniversal (5895 200.109-00) with Universal Buckets (5895 202.101-00\*) and Caps (5910 750.120-00<sup>#</sup>) was containment tested in an Eppendorf bench top centrifuge, using Annex AA of IEC 61010-2-020:2016 (3<sup>rd</sup> Ed.). The sealed buckets were shown to contain a spill.

**Report Written By**

**Name:** Ms Anna Moy  
**Title:** Biosafety Scientist

**Report Authorised By**

**Name:** Mrs Sara Speight  
**Title:** Senior Biosafety Scientist

Please be aware that the use of the Royal Coat of Arms is highly restricted and cannot be copied. Please do not put the PHE logo on your website or use our name to endorse your products. Any reference to PHE needs to be approved by us before it can be used.

\* Part no. will form part of catalogue number 5895 200.001; 5895 202.004; 5895 203.000

# Part no. will form part of catalogue number 5910 750.005



# Evaluate Your Manual

Give us your feedback.  
[www.eppendorf.com/manualfeedback](http://www.eppendorf.com/manualfeedback)



Eppendorf SE  
Barkhausenweg 1  
22339 Hamburg  
Germany

Your local distributor: [www.eppendorf.com/contact](http://www.eppendorf.com/contact)  
[eppendorf@eppendorf.com](mailto:eppendorf@eppendorf.com) · [www.eppendorf.com](http://www.eppendorf.com)